

# Mixtus Dual-band Wi-Fi SMD Antenna

Part No. A10194

gigaNOVA®

Product Specification

## 1 Features

- Designed for 2.4 – 2.5 GHz and 4.9 – 5.9 GHz applications: 802.11a/b/g/j/n, Wi-Fi®
- Easy to integrate
- High efficiency
- Light weight
- Intended for SMD mounting
- Supplied in tape on reel

## 2 Description

Mixtus is intended for use with all dual-band Wi-Fi applications, including 802.11n MIMO. The antenna requires a ground plane, i.e. your device acts as an active part of the antenna and thus demands careful consideration concerning its placement.

## 3 Applications

- Mobile phones
- PDAs
- Portable Media Players (PMPs)
- Headsets
- PC-Cards
- Game Consoles
- Access Points
- Set-top-box
- Networked Digital TVs



## 4 Part No.

### Mixtus: A10194



## 5 General data

Product name	Mixtus Wi-Fi
Part No.	A10194
Frequency	2.4 – 2.5 GHz and 4.9 – 5.9 GHz
Polarization	Linear
Operating temperature	-40 °C to +85 °C
Impedance with matching	50 Ω
Weight	0.2 g
Antenna type	SMD
Dimensions	10 x 10 x 0.9 [mm]

## 6 Electrical characteristics

	Typical performance	Conditions
Peak gain	1.8 dBi	<b>Data given for the 2.4 – 2.5 GHz frequency range</b> All data measured on Antenova's reference board part number A10194-U1
Average gain	-0.5 dBi	
Average efficiency	>75%	
Maximum Return Loss	-15 dB	
Maximum VSWR	1.4:1	
Peak gain	4.1 dBi	<b>Data given for the 4.9 – 5.9 GHz frequency range</b> All data measured on Antenova's reference board part number A10194-U1
Average gain	-2.3 dBi	
Average efficiency	>60%	
Maximum Return Loss	-11 dB	
Maximum VSWR	1.8:1	

## 7 Electrical performance

### 7-1 Return Loss

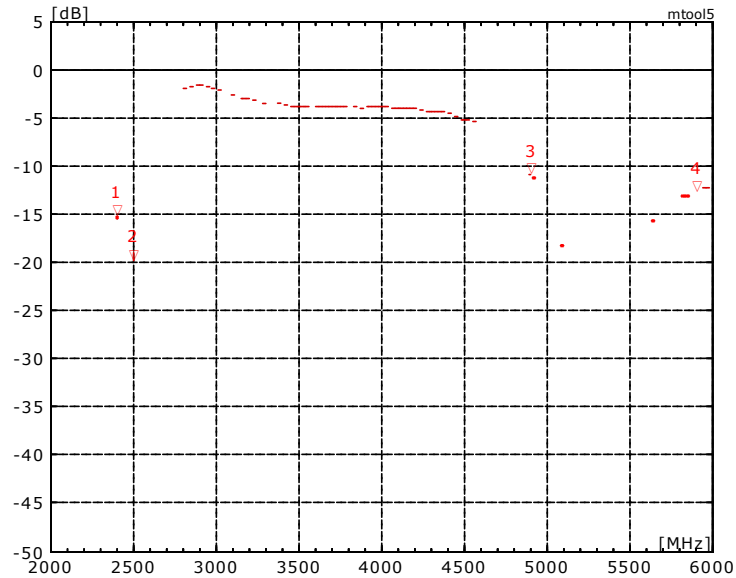

### 7-2 VSWR

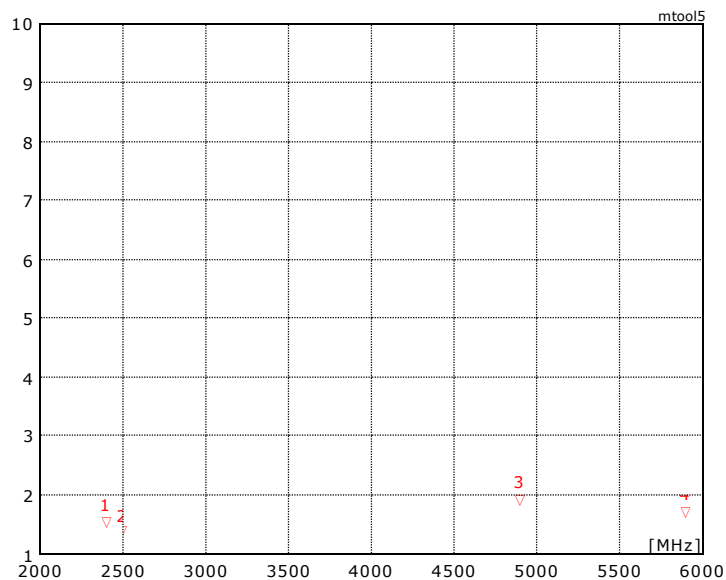

### 7-3 Antenna patterns

#### 7.3.1. 2400 MHz – 2500 MHz

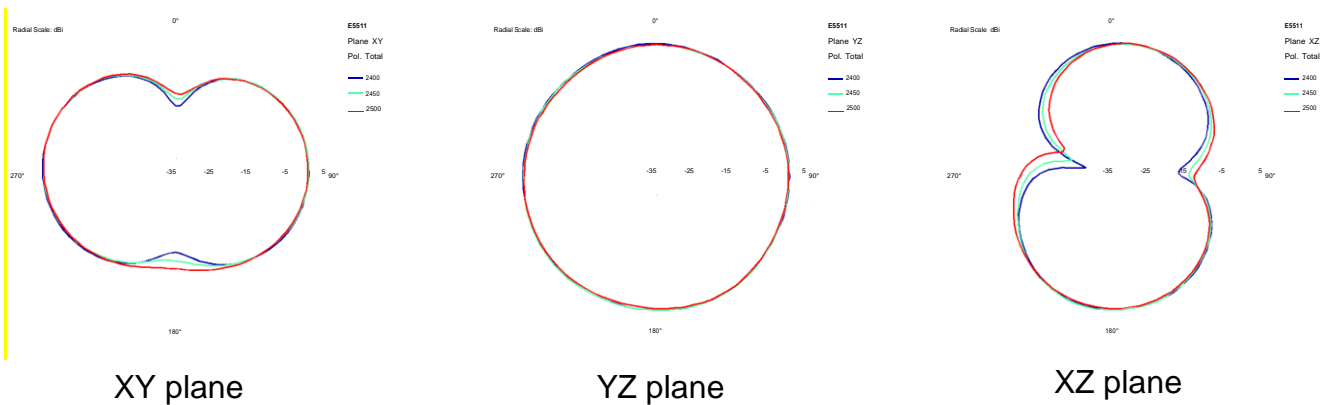
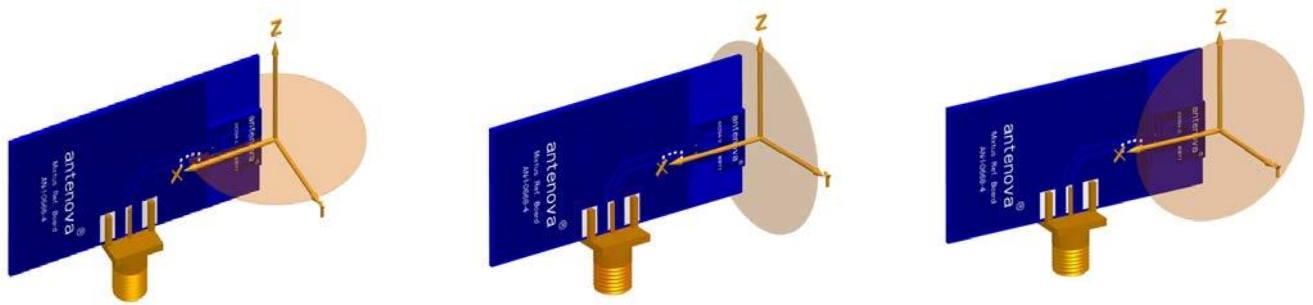
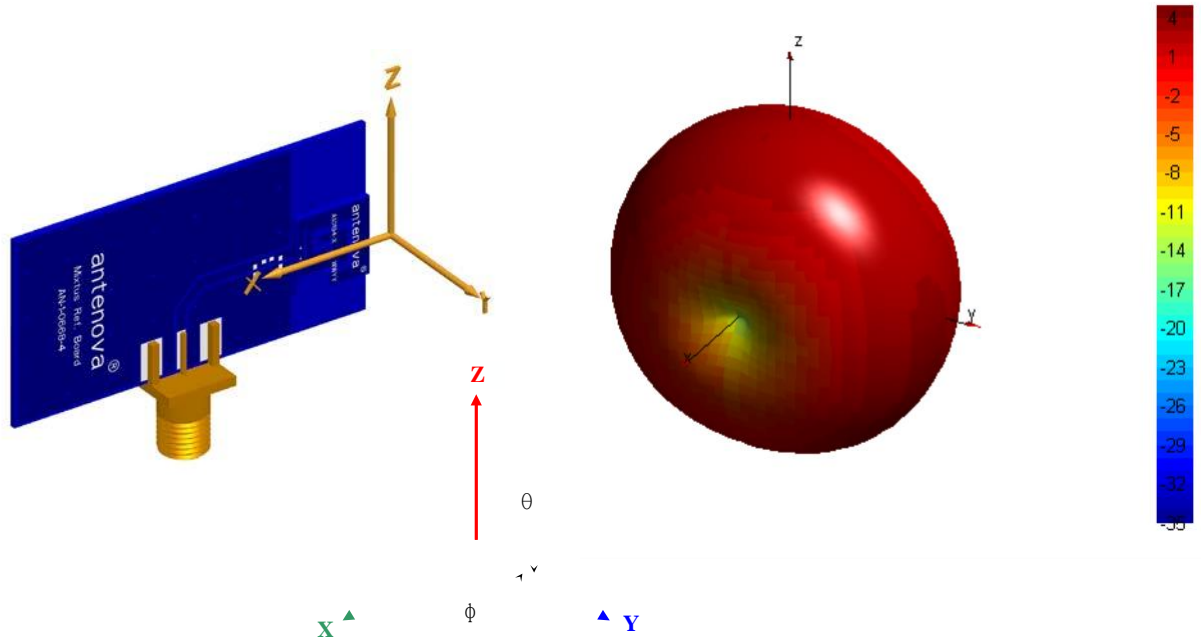

Patterns show combined polarisations  
measured on reference board A10194-U1

### 7.3.2. 4900 MHz – 5900 MHz

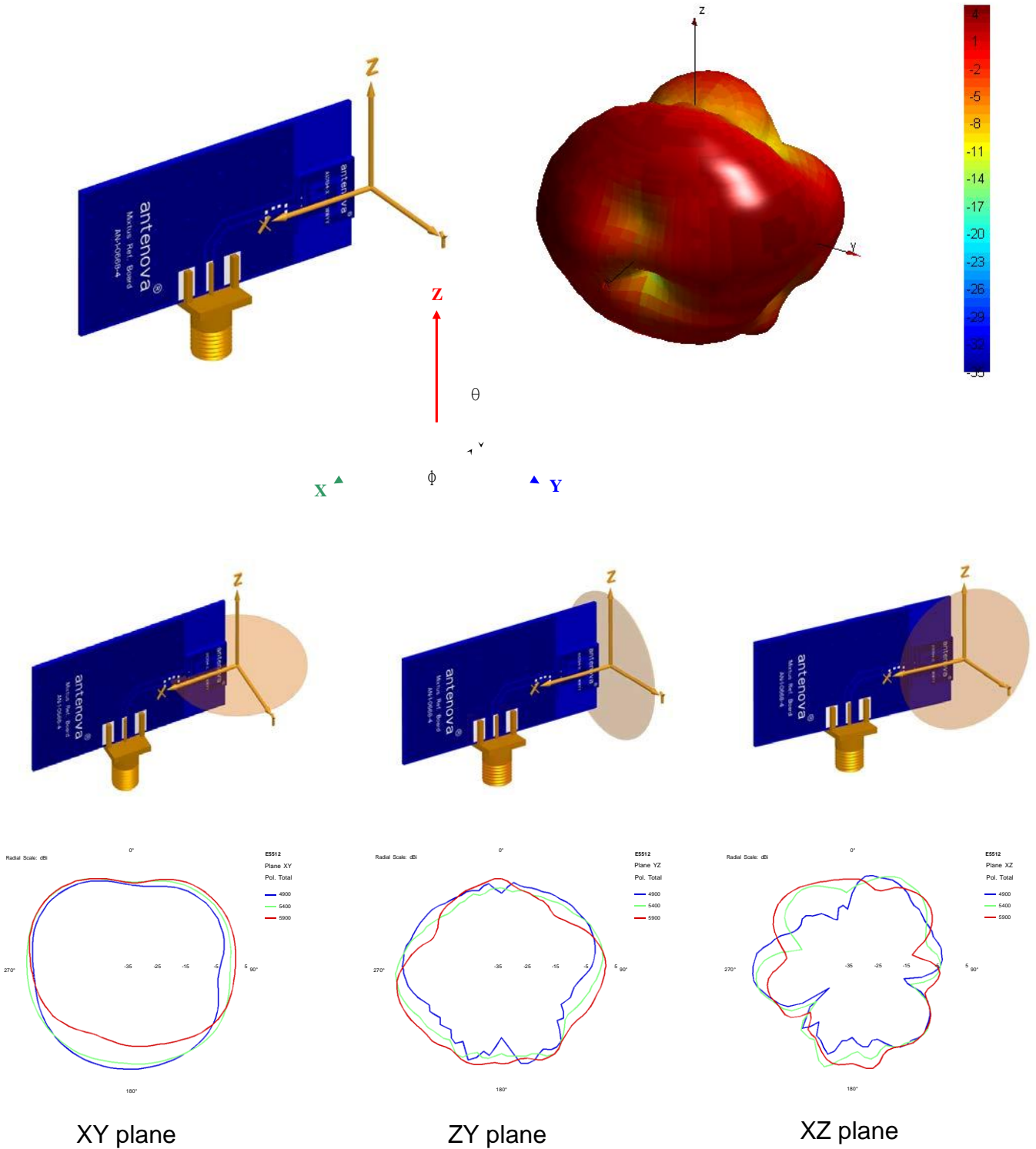

Patterns show combined polarisations  
measured on reference board A10194-U1

## 8 Antenna dimensions

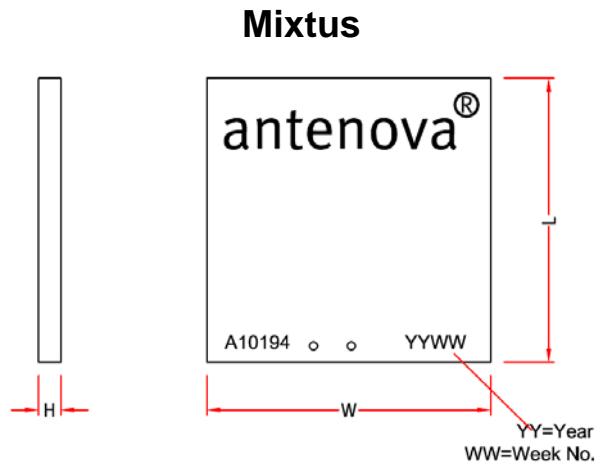

L	W	H
Length	Width	Height
10.4 ± 0.2	10.4 ± 0.2	0.8 ± 0.15

Dimensions in mm

## 9 Antenna footprint

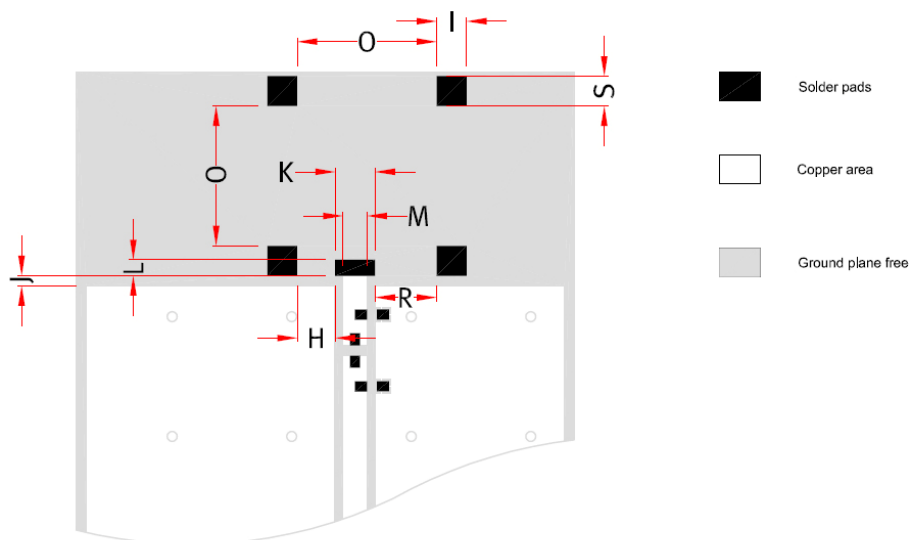

### Mixtus (Part No: A10194)

CAD files of the antenna footprint are available from Antenna M2M on request.  
Please contact [sales@antenna-m2m.com](mailto:sales@antenna-m2m.com) for further details.

I	S	K	J	M	O	H	R	L
1.5 ± 0.1	1.5 ± 0.1	2.0 ± 0.1	0.5 ± 0.1	1.2 ± 0.1	7.0 ± 0.1	1.9 ± 0.1	3.1 ± 0.1	0.8 ± 0.1

Dimensions in mm

## 10 Electrical interface

### 10-1 Transmission lines

- All transmission lines should be designed to have a characteristic impedance of  $50 \Omega$
- The length of the transmission lines should be kept to a minimum.
- Any other parts of the RF system like transceivers, power amplifiers, etc, should also be designed to have an impedance of  $50 \Omega$

Once the material for the PCB has been chosen (PCB thickness and dielectric constant), a coplanar transmission line can easily be designed using any of the commercial software packages for transmission line design. For the chosen PCB thickness, copper thickness and substrate dielectric constant, the program will calculate the appropriate transmission line width and gaps on either side of the track so the characteristic impedance of the coplanar transmission line is  $50 \Omega$ .

### 10-2 Matching circuit

The antenna requires a matching circuit that must be optimized for each customer's product. The matching circuit will require up to three components and the following pad layout should be designed into the device so the correct circuit can be installed:

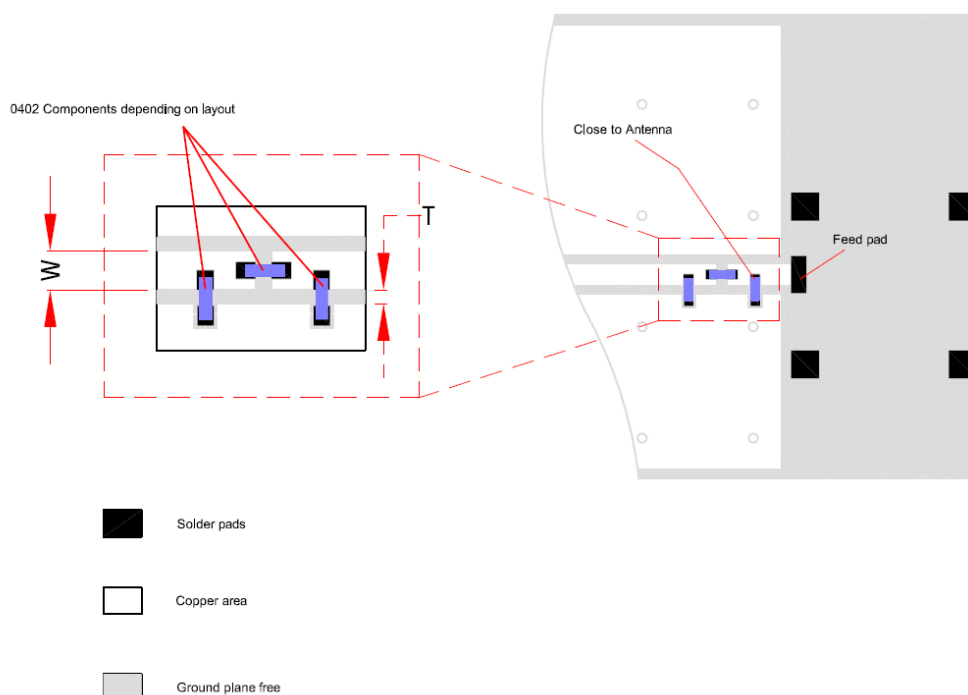

The antenna feed pad and the antenna ground pad are indicated in the drawing above. Additional pads are for mechanical attachment only and should not be grounded.

In addition to the matching circuit, a separate DC blocking capacitor will also be required between the radio and the antenna matching circuit.

**Note: The component values for the matching circuit will vary depending on the size of the PCB and surrounding components.** The impedance of the antenna should be measured before selecting suitable matching components. Antenova M2M offers this service on request. Contact [sales@antenova-m2m.com](mailto:sales@antenova-m2m.com) for further information.

### 10-3 Antenna placement

Antenova M2M strongly recommends placing the antenna near the edge of the board. Maximum antenna performance is achieved by placing the antenna towards one of the corners of the PCB and with the feed point of the antenna as close to the same corner of the PCB as possible.

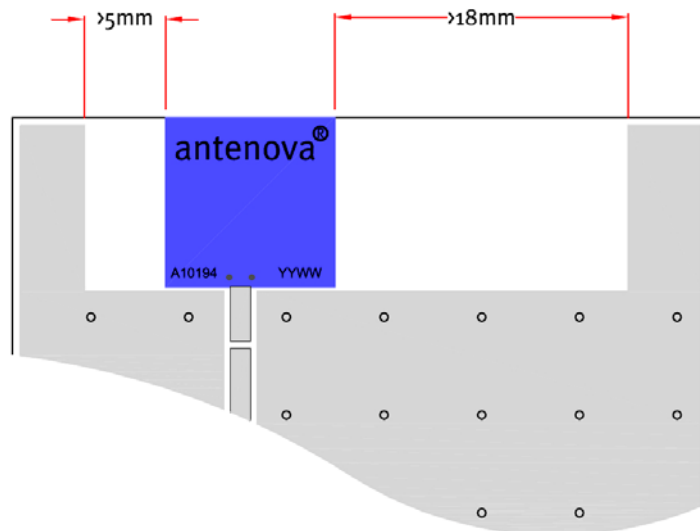

Additional ground and components near the antenna should be at a distance of at least 5 mm from the left hand side and 18 mm or more from the right hand side as shown in the drawing above.



## 10-4 Reference boards

The reference boards have been designed for evaluation purposes of Mixtus dual-band Wi-Fi SMD antenna and they include a SMA female connector

### Mixtus

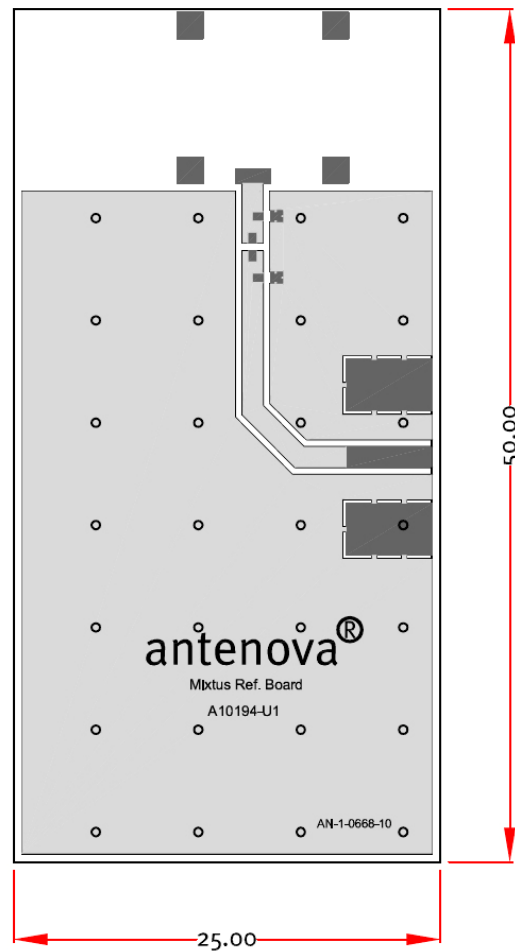

Dimensions in mm

To order a reference board contact [sales@antenna-m2m.com](mailto:sales@antenna-m2m.com).

## 11 Soldering

This antenna is suitable for lead free soldering.

The reflow profile should be adjusted to suit the PCBA, oven and solder paste, while observing the following conditions:

### RECOMMENDED CONDITION OF REFLOW SOLDERING

- 1.Pre Heating Rate : 1 to 5 deg./s
- 2.Pre Liminary Heating : 130 to 170 deg. ,  
50 to 120s
- 3.Reflow Heating Rate : 1 to 5 deg./s
- 4.Soldering : 230 deg. , 20 to 30s
- 5.Peak Temperature : 245 to 260 deg. ,  
10s Max.
- 6.Cooling : 60s Min.
- 7.Number of Reflow Soldering : 2 times Max.

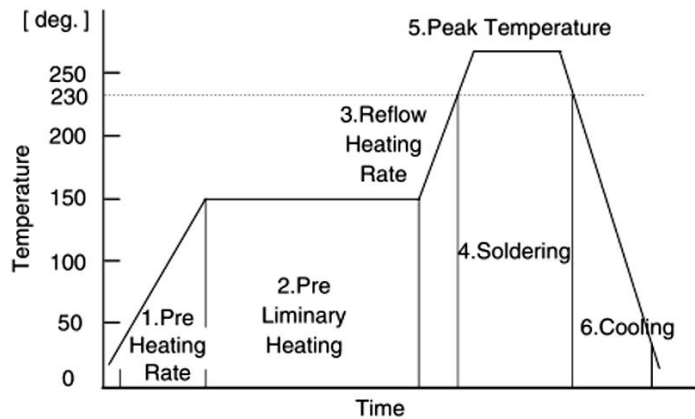

\* Recommended peak temperature is over 245 degree. If peak temperature is below 245 degree., you may adjust the following parameters ; Time length of peak temperature (longer), Time length of soldering (longer), Thickness of solder paste (thicker).

## 12 Hazardous material regulation conformance

The antenna has been tested to conform to RoHS requirements. A certificate of conformance is available from Antenova M2M's website.

## 13 Packaging

### 13-1 Optimal storage conditions for packaged reels

<b>Temperature</b>	-10°C to 40°C
<b>Humidity</b>	Less than 75% RH
<b>Shelf Life</b>	18 Months
<b>Storage place</b>	Away from corrosive gas and direct sunlight
<b>Packaging</b>	Reels should be stored in unopened sealed manufacturer's plastic packaging.

**Note:** Storage of open reels of antennas is not recommended due to possible oxidization of pads on antennas. If short term storage is necessary, then it is highly recommended that the bag containing the antenna reel is re-sealed and stored in like storage conditions as in above table.

### 13-2 Tape characteristics

**Mixtus**  
[Part Number: A10194]

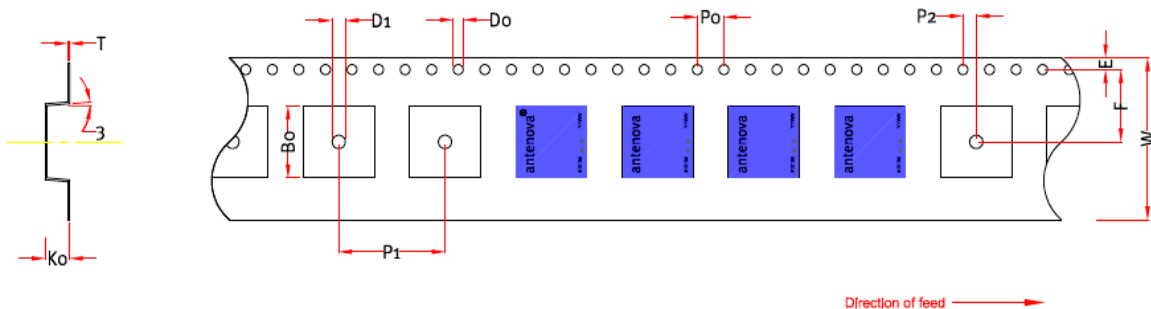

W	F	E	P0	P1	P2	B0	K0	T	D0	D1
24 ± 0.2	10.7 ± 0.1	1.75 ± 0.1	4.0 ± 0.1	16.0 ± 0.1	2.0 ± 0.1	10.7 ± 0.1	1.1 ± 0.1	0.3 ± 0.05	Min 1.55 ± 0.1	Min 2.0 ± 0.2

Dimensions in mm

Quantity	Leading Space	Trailing Space
2000 pcs / reel	50 blank antenna holders	50 blank antenna holders

### 13-3 Reel dimensions

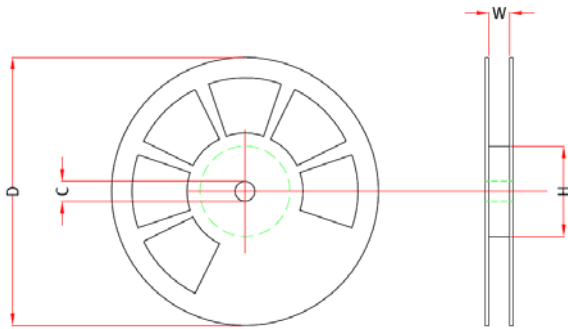

Width (W)	Reel Diameter (D)	Hub Diameter (H)	Shaft Diameter (C)
57.5 mm	330 mm ± 2.0	80 mm (2")	13.0 mm ± 0.5

### 13-4 Box dimensions

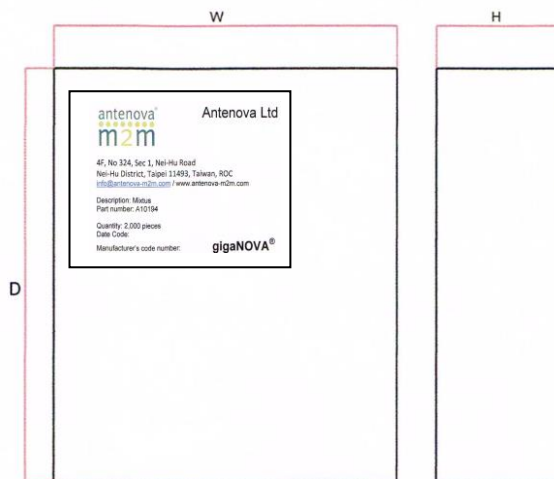

Width (W)	Breadth (B)	Thickness (H)
338 mm	335 mm	45 mm

### 13-5 Bag properties

Reels are supplied in protective plastic packaging

## 13-6 Reel label information

### Mixtus



Dimensions in mm



**[www.antenova-m2m.com](http://www.antenova-m2m.com)**

**Corporate Headquarters**

Antenova Ltd.  
2<sup>nd</sup> Floor, Titan Court  
3 Bishop Square  
Hatfield  
AL10 9NA

**North America Headquarters**

Antenova Ltd.  
Rogers Business Park  
2541 Technology Drive Suite 403  
Elgin, IL 60124

**Asia Headquarters**

Antenova Asia Ltd.  
4F, No. 324, Sec. 1, Nei-Hu Road  
Nei-Hu District  
Taipei 11493  
Taiwan, ROC

**Tel:** +44 1223 810600  
**Email:** sales@antenova-m2m.com

**Tel:** +1 (847) 551 9710  
**Email:** sales@antenova-m2m.com

**Tel:** +886 (0) 2 8797 8630  
**Fax:** +886 (0) 2 8797 6890  
**Email:** sales@antenova-m2m.com

**Copyright® Antenova Ltd.** All Rights Reserved. Antenova®, Antenova M2M®, gigaNOVA®, and the Antenova and Antenova M2M logos are trademarks and/or registered trademarks of Antenova Ltd. Any other names and/or trademarks belong to their respective companies.

The materials provided herein are believed to be reliable and correct at the time of print. Antenova does not warrant the accuracy or completeness of the information, text, graphics or other items contained within these information. Antenova further assumes no responsibility for the use of this information, and all such information shall be entirely at the user's risk.



Certificate No: 4598

**Antennas for Wireless M2M Applications**