

STRAIGHT

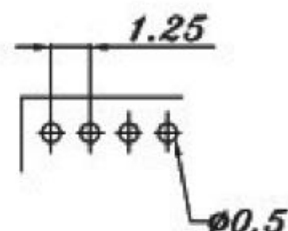

PCB LAYOUT

RIGHT ANGLE

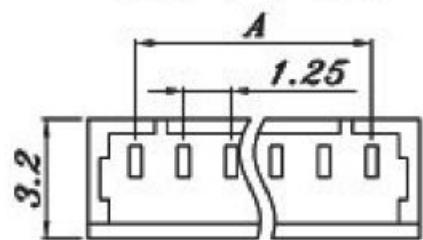
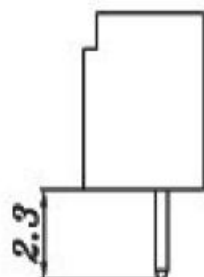
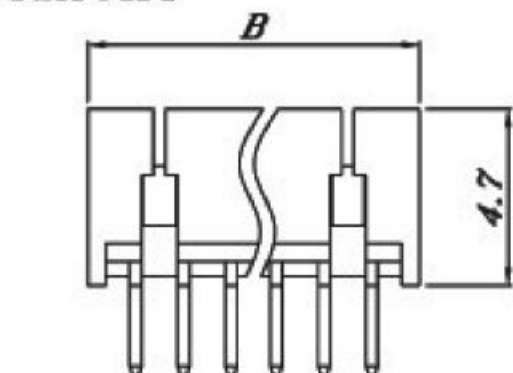
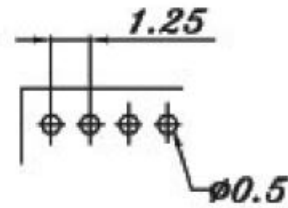
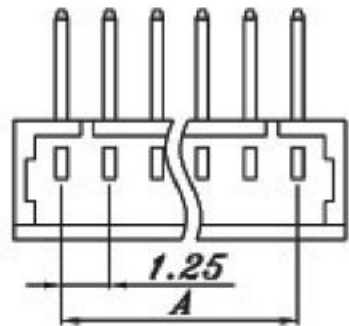
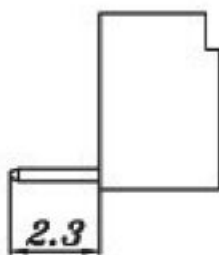
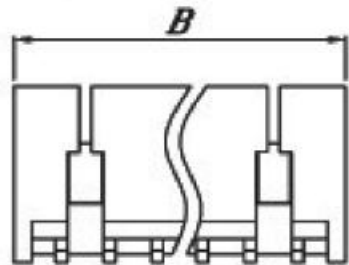

PCB LAYOUT

CIRCUITS	DIMENSION(MM)		CIRCUITS	DIMENSION(MM)	
	A	B		A	B
2	1.25	4.25	9	10.00	13.00
3	2.50	5.50	10	11.25	14.25
4	3.75	6.75	11	12.50	15.50
5	5.00	8.00	12	13.75	16.75
6	6.25	9.25	13	15.00	18.00
7	7.50	10.50	14	16.25	19.25
8	8.75	11.75	15	17.50	20.50

PROJECTION 	TOLERANCE UNLESS OTHERWISE SPECIFIED XX ± 0.5 X ± 0.25 .XX ± 0.10 .XXX ± 0.05		YIMTEX 穎錕企業有限公司 YIMTEX ELECTRONIC CO., LTD.	
	UNITS MM			DATE. 02/03/08
APPROVAL CHECKED MARK	DRAWING 陳常雨	TITLE. 1.25mm wafer	PART NO. 501MW-SERIES	DWG NO. YM-501MW-0001

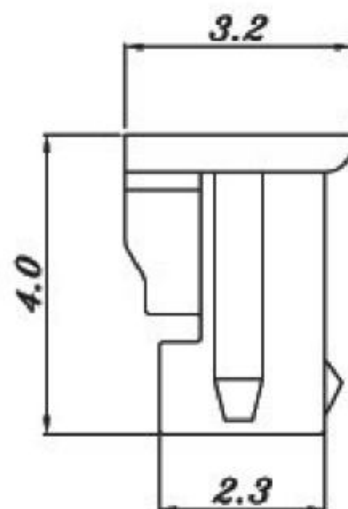
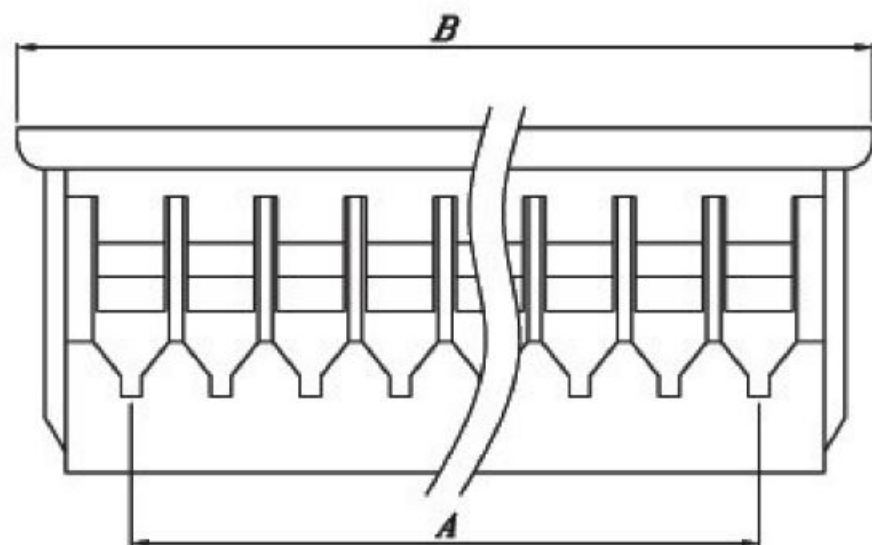

Circuits	Dimension	
	A	B
2	2.95	4.25
3	4.20	5.50
4	5.45	6.75
5	6.70	8.00
6	7.95	9.25
7	9.20	10.50
8	10.45	11.75
9	11.70	13.00
10	12.95	14.25
11	14.20	15.50
12	15.45	16.75
13	16.70	18.00
14	17.95	19.25
15	19.20	20.50

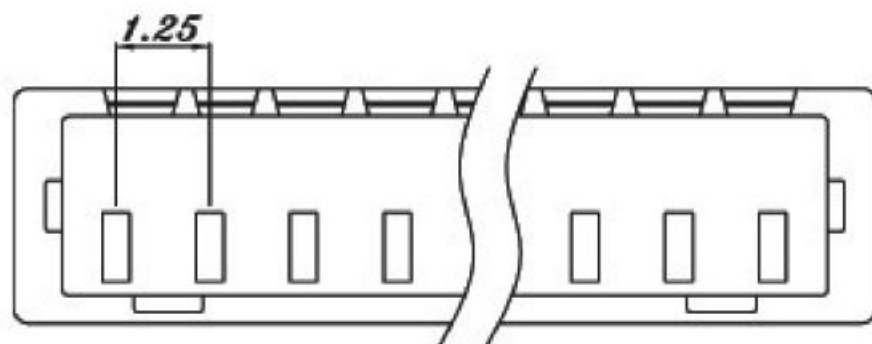

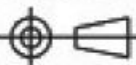
PROJECTION 	TOLERANCE UNLESS OTHERWISE SPECIFIED <i>XX</i> ± 0.5 <i>X</i> ± 0.25 <i>.XX</i> ± 0.10 <i>.XXX</i> ± 0.05		YIMTEX 穎錕企業有限公司 YIMTEX ELECTRONIC CO., LTD.	
	UNITS MM			DATE. 02/03/08 REVISE. A/0
APPROVAL		CHECKED MARK	DRAWING 陳常剛	TITLE. 1.25mm HOUSING PART NO. 501MH-SERIES DWG NO. YM-501MH-0001

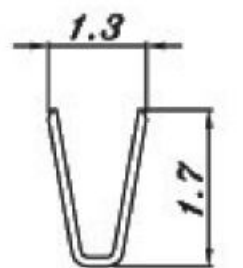

A—A

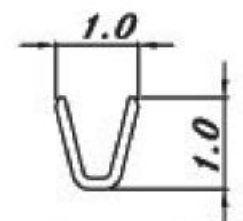

B—B

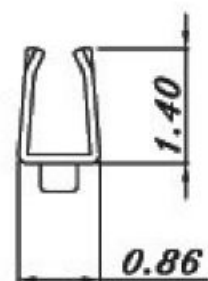

C—C

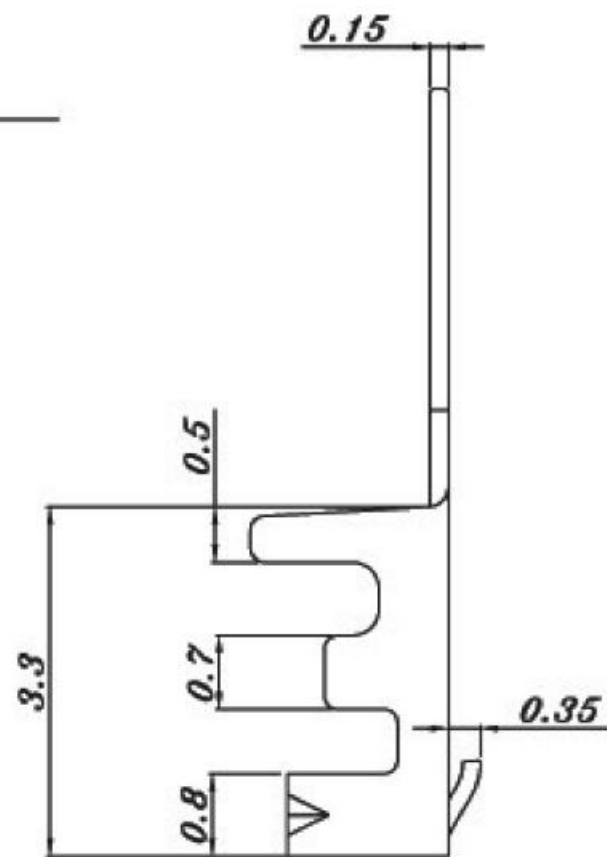
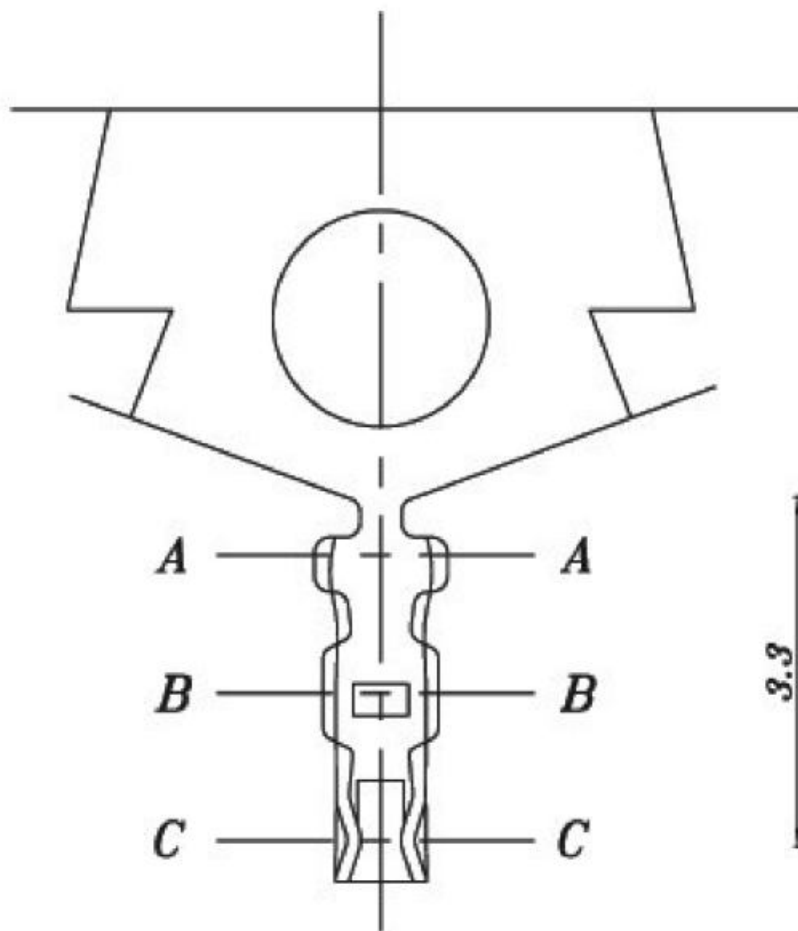

PROJECTION 	TOLERANCE UNLESS OTHERWISE SPECIFIED		YIMTEX 穎錕企業有限公司 YIMTEX ELECTRONIC CO., LTD.	
	$XY \pm 0.5$ $.X \pm 0.25$ $.XX \pm 0.10$ $.XXX \pm 0.05$		DATE.	02/03/08
UNITS MM			REVISE.	A/0
APPROVAL	CHECKED	DRAWING	TITLE.	1.25mm TERMINAL
	MARK	陳常雨	PART NO.	501MT-SERIES
			DWG NO.	YM-501MT-0001