

Specifications 规格

Electrical

Current Rating 电流额定值: 3 Amp
 Voltage Rating 电压额定值: 300 V
 Insulation Resistance 绝缘电阻值: 1000 MΩ min.
 Dielectric Withstanding 耐电压: 1700 V AC
 Contact Resistance 接触电阻值: 20 mΩ max.

Material

Insulator Material 绝缘体物料: LCP, UL 94V-0, Natural
 Contact Material 端子物料: Phosphor Bronze
 Solder Tab Material 物料: Brass
 Contact Plating 端子电镀: 70μ" min. Tin over 30μ" min. Nickel
 Solder Tab Plating 焊片电镀: 70μ" min. Tin over 30μ" min. Nickel

Soldering Process 可焊性:

IR Reflow 回流焊: 260°C +0°C/-5°C for 5-10 sec.
 Manual Solder 人工焊接: 350°C for 3 sec.

Environmental

Operating Temperature 工作温度: -55°C to +105°C

Mates with 配套之母座

BJ301

Ordering Grid



No. of Contacts

02

Contact Plating

Y = 70μ" Tin

Packing

A = Tape & Reel
 (2800 per reel)

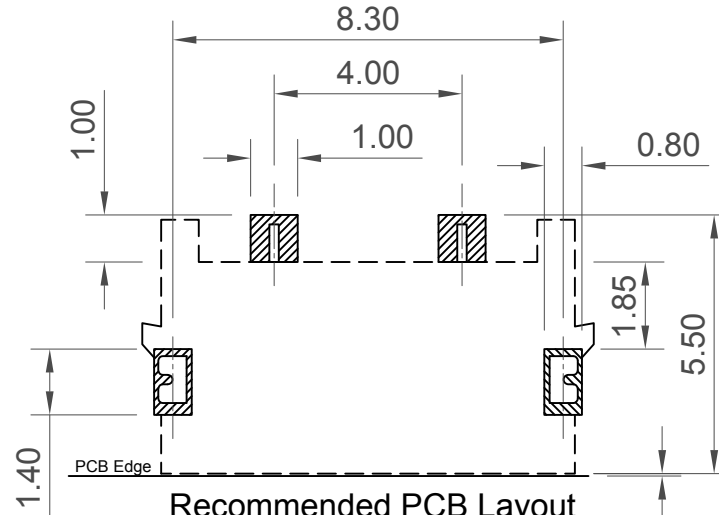
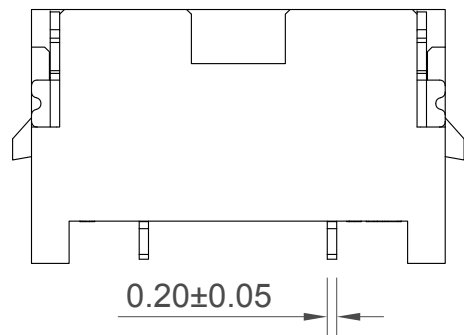
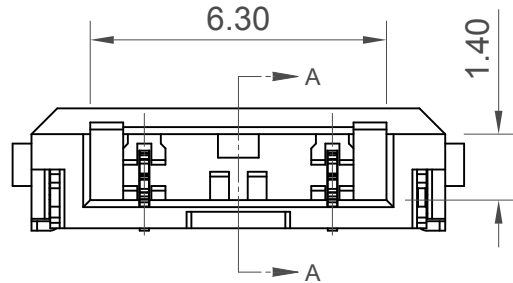
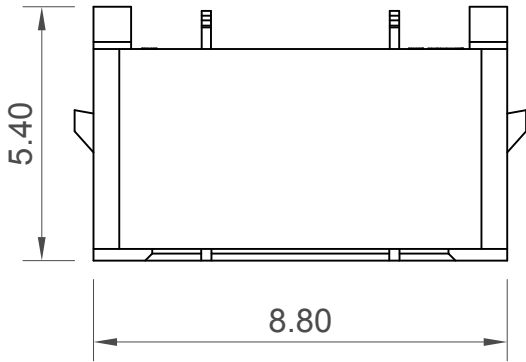
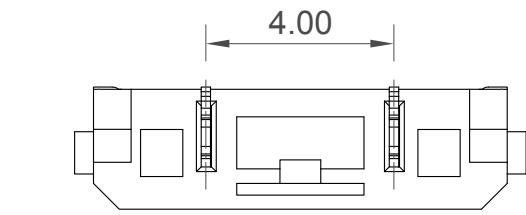



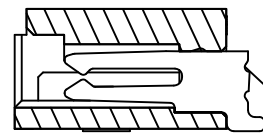
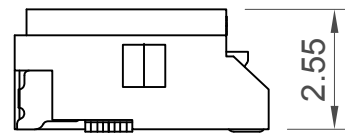

Recommended PCB Layout
 (Tolerance: ±0.05mm)

 Solder Area  Component Outline

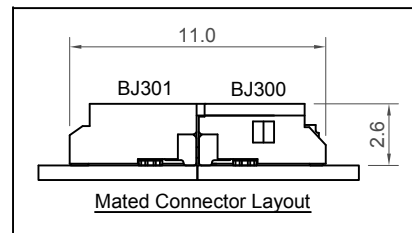

Section A-A



Part Number		Product Description		  This drawing is confidential and copyright of Global Connector Technology, Ltd (GCT). This drawing must not be copied or disclosed without written consent. E & OE		 Global Connector Technology www.gct.co	
BJ300		4.0mm Pitch Socket - Single Row, Surface Mount, Horizontal					
Drawing Date		12th September 2014					
By		AJO					
Detail	Drawing Release	Tolerances (Except as Noted)	Units:	 Metric (mm)		Not to Scale Drawn By AJO Sheet No. 1/2	
Revision	A1	Length	Angle				
Date	29/10/14	X.X ± 0.30 X.XX ± 0.20 X.XXX ± 0.10					

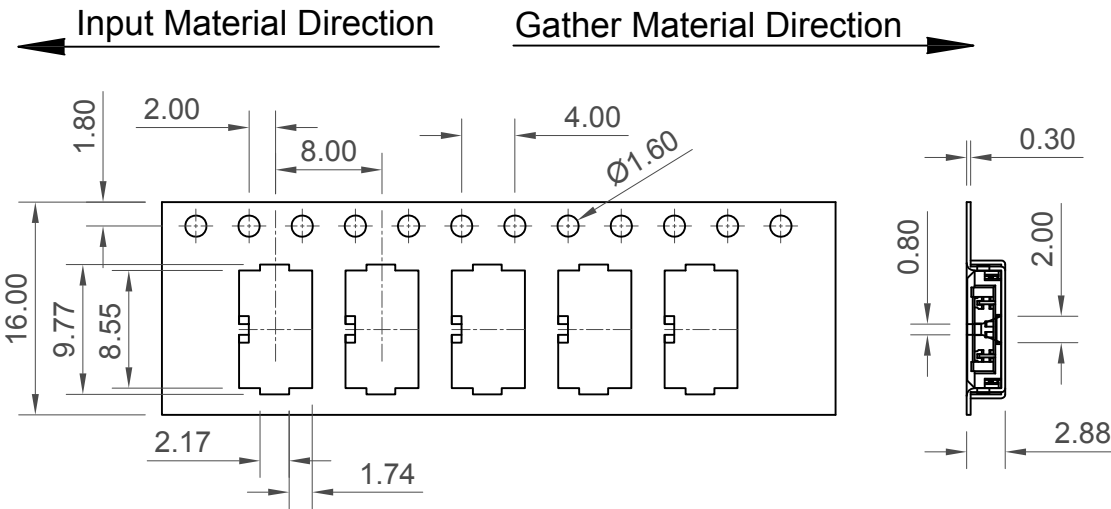
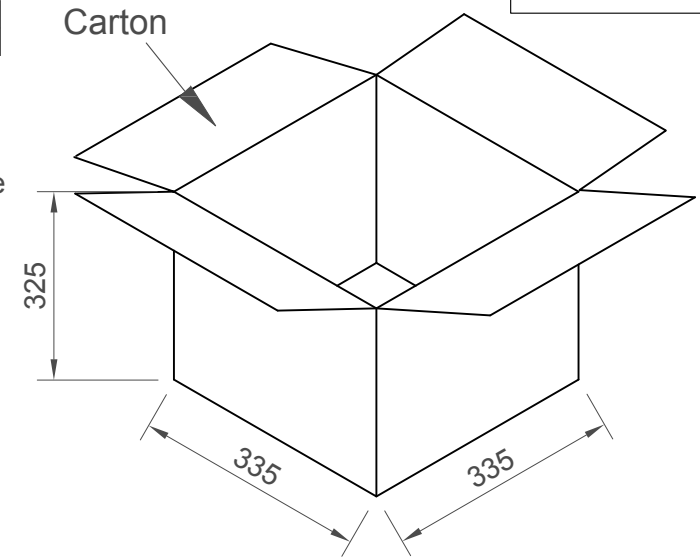
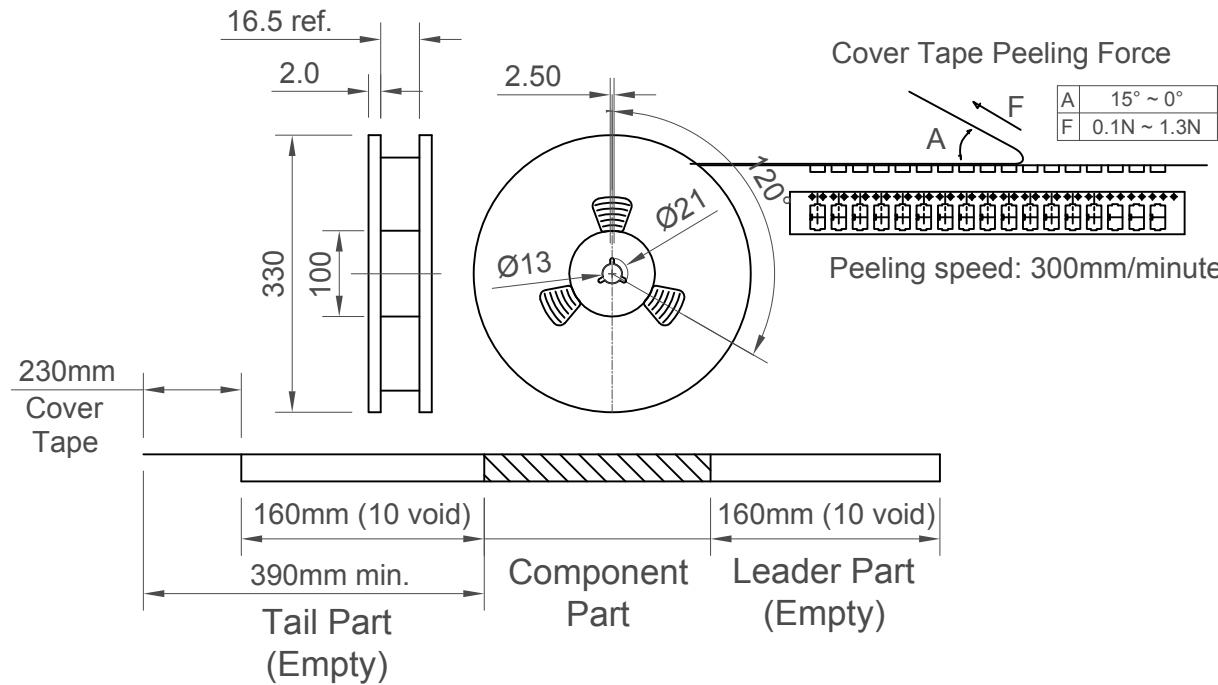

Part Number	Specification	Q'ty
Cover Tape	0.05 x 21.3mm	25m/Reel
Reel	330 x 100 x 20.5mm, Blue	15/box
Bag	900 x 700 x 0.10mm, PE	1/box
Carton	335 x 335 x 325mm	1/box
Label on T&R	90 x 70mm	15/box
Label on Carton	125 x 75mm	1/box
Desiccant	10g	1/Reel

Part Number	Pcs./Reel	Reels/Carton	Pcs./Carton
BJ300	2800	10	28000

Part Number BJ300		Product Description 4.0mm Pitch Socket - Single Row, Surface Mount, Horizontal	
Drawing Date 12th September 2014			
By AJO	Drawing Release	Tolerances (Except as Noted)	Units: Metric (mm)
Detail	A1	Length X.X ± 0.3	
Revision	29/10/14	Angle X.XXX ± 0.2	
Date		X.XXXX ± 0.1	

This drawing is confidential and copyright of Global Connector Technology, Ltd (GCT). This drawing must not be copied or disclosed without written consent. E & OE