



FORTE BATTERY

LITHIUM MANGANESE DIOXIDE BATTERY

锂二氧化锰电池 | 型号: CR34615

Characteristics 性能数据

Nominal capacity(10mA-2.0v).....	12000mAh
标称容量	
Nominal voltage.....	3.0v
额定电压	
Max.constant current.....	2000mA
最大连续工作电流	
Max.pulse current.....	3000mA
最大脉冲电流	
Weight.....	125g
电池重量	
Volume.....	Φ 34.0X61.5mm
电池尺寸	
Workable temperature.....	-40℃~+60℃
工作温度	

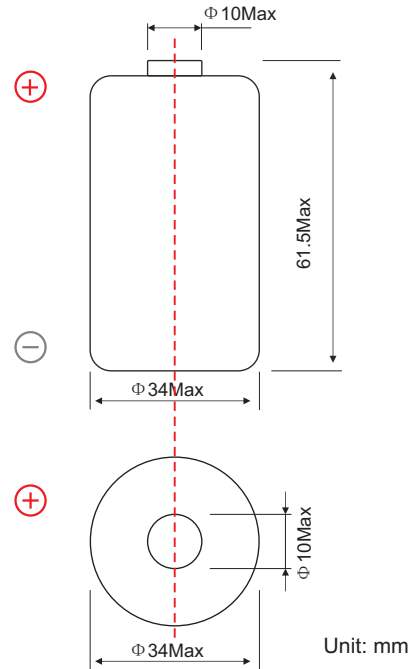

Temperature Characteristics 温度特性

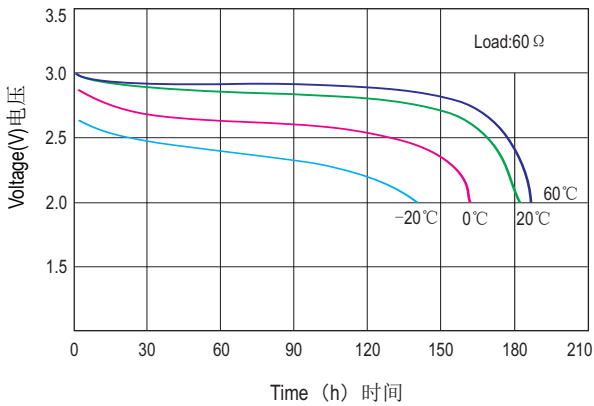

Discharge Characteristics 常温负载特性

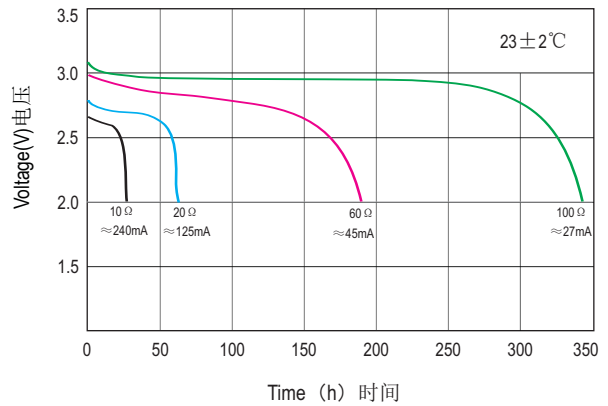

Load-Capacity Characteristics 容量\温度\电流

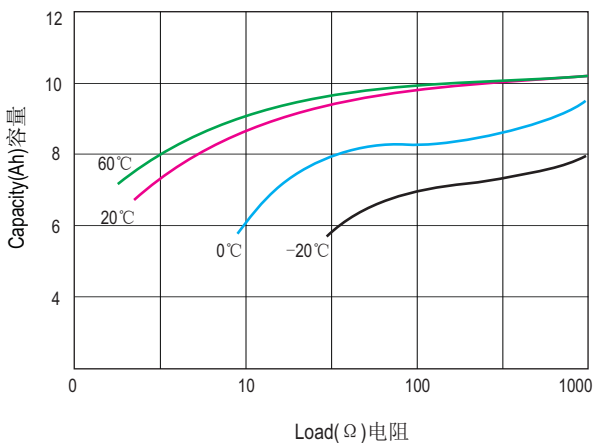

Storage characteristics 存储特性

