

# SPECIFICATION FOR APPROVAL

## 納入仕様書

Customer : \_\_\_\_\_  
Description : **Speaker Ass'y**  
Kingstate Part No. : **KDMG10008CL-03**  
Customer's Model No. : \_\_\_\_\_  
Specification No. : **PKD-7699**  
Number Of The Edition : **1.1**

CUSTOMER'S APPROVED SIGNATURE		

志豐電子股份有限公司 KINGSTATE ELECTRONICS CORP.



Address: 10F, No. 69-11, Sec. 2, Chung Cheng E. Rd., Tamshui County, Taipei Hsien, Taiwan, R.O.C.

International sales dept.: TEL:886-2-2809-5651 FAX:886-2-2809-7151

Domestic sales dept.: TEL:886-2-2809-0668 FAX:886-2-28096748

<http://www.kingstate.com.tw>

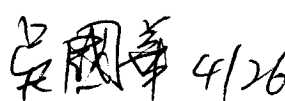
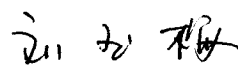
Approved by	Checked by	Issued by
 4/26	 2006.4.26	Fei 4/25/06'

## A. SCOPE 範疇

This specification applies speaker, **KDMG10008CL-03**

此規格書適用於喇叭，**KDMG10008CL-03**

## B. SPECIFICATION 規格

No.	Item	Symbol	Unit	Specification	Condition
1	Dimension 尺寸		mm	10.0 x 2.35	
2	Power Rating 功率		W	Rated. 0.3/ MAX. 0.5	Maximum Power:IEC-60268-5 Filter 60s On/120s Off 10 Cycles (Room TEMP.)
3	Impedance 阻抗		ohm	8 ± 15%	At 1.5KHz 1.0V
4	Resonance Frequency 低音諧振	Fo	Hz	1200 ± 20%	At ,1.0V
5	Output S.P.L. 音壓位準		dB	86 ± 3dB(0.3w/10cm) 72 ± 3dB(1w/1m)	At 1.0k,1.2k,1.5k,2.0kHz (Average figures)
6	Frequency Range 有效頻寬		Hz	Fo---20K	
7	Distortion 失真		%	10% Max.	At 1.5kHz , 0.3W
8	Voice Coil 音圈		mm		
9	Magnet 磁石		mm	5.2 x 0.7	Nd-Fe-B (鈹鐵錳)
10	Flux Density 磁通密度		Gauss		
11	Operating temp. 操作溫度			-30 ~ +85	
12	Buzze & Rattle 異常音				Not be audible at 1.55V sine wave between Fo ~ 20KHz 輸入 1.55V 正弦波從 Fo 到 20KHz 之間無異常音 .
13	Weight 重量		g	0.50	
14	Material 材質			Metal	
15	Environmental Protection Regulation 環保法規			RoHS	

### C. TYPICAL FREQUENCY RESPONSE CURVE 頻率響應曲線

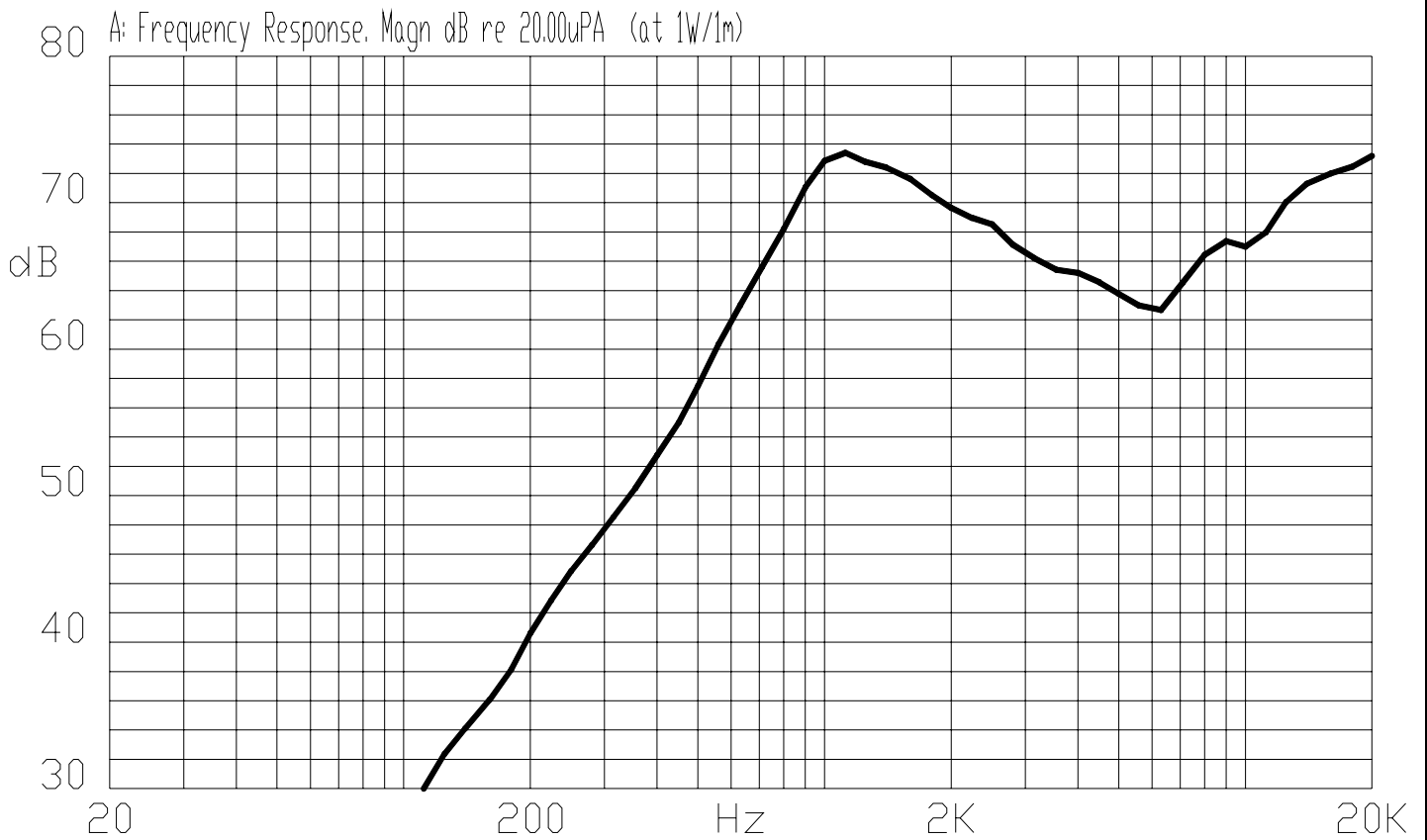
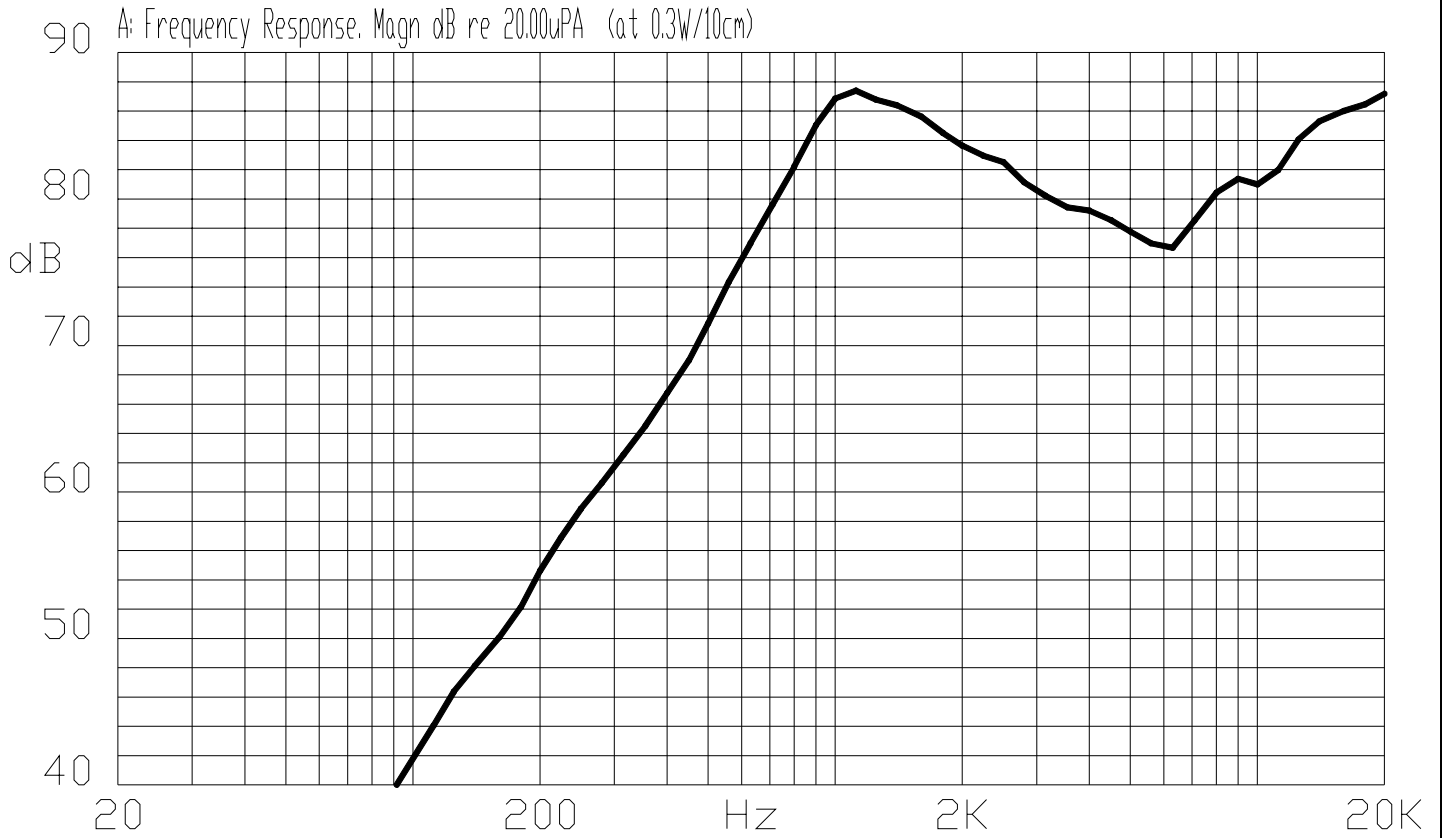

## D. APPEARANCE DRAWING 外觀尺寸圖

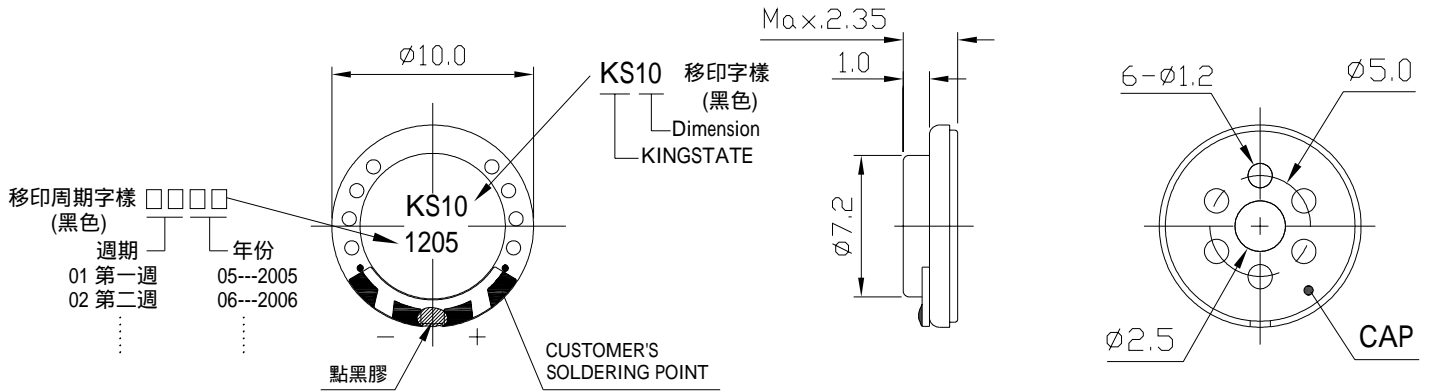

Tol:  $\pm 0.2$

Unit: mm

## E. MEASUREMENT CIRCUIT 測量線路

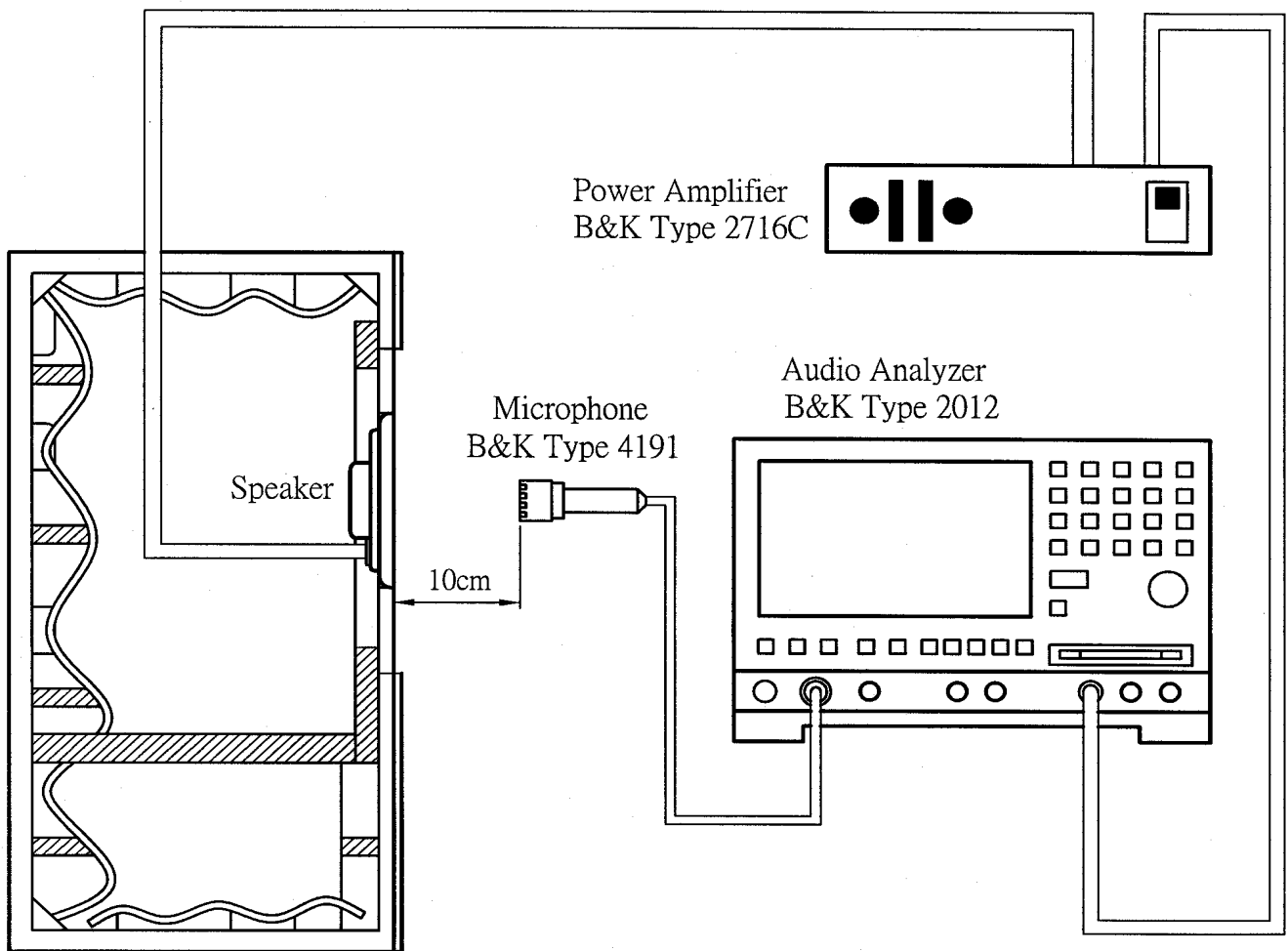

JIS C5531

940mm x 640mm x 1240mm

## F. MECHANICAL CHARACTERISTICS 機械特性

No.	Item	Test condition	Evaluation standard
1	PCB Wire Pull Strength PCB 線材拉力	The pull force shall be applied to double lead wire : Horizontal 3.0N(0.306kg) for 30 seconds. 雙線材水平方向施以 3.0N(0.306kg)的力量,30 秒.	No damage and cutting off. 不鬆動,不脫落.
2	Vibration Test 振動測試	Speaker shall be measured after being applied vibration of amplitude of 1.5mm with 10 to 55Hz band of vibration frequency to each of 3 per-pendicular directions for 2 hours. 振動週波數 10 ~ 55Hz、全振幅 1.5mm 於 X.Y.Z 3 個方向, 各 2 小時	No obstacle to be harmful to normal operation; damages, cracks, rusts and distortions. Should not be audible at 1.55V sine wave between Fo ~ 20KHz
3	Drop Test 落下測試	Drop the speakers contained in normal box onto the board 40mm thick 10 times from the height of 75cm 將揚聲器置於盒中, 自 75 公分高度落在 40mm 木板上共 10 次	測試後無任何障礙防礙正常操作. 且在輸入 1.55V 正弦波從 Fo 到 20KHz 之間無異常音.

## G. ENVIRONMENTAL TEST 環境試驗

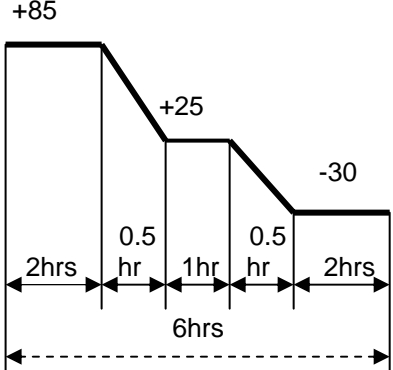
No.	Item	Test conditions	Evaluation standard
1	High temp. Test 高溫測試	After being placed in a chamber at +85 for 96 hours 置於+85 環境中 96 小時	Being placed for 6 hours at +25 , speaker shall be measured. No obstacle to be harmful to normal operation; damages, cracks, rusts, etc. Should not be audible at 1.55V sine wave between Fo ~ 20KHz. Fo should meet initial one. S.P.L. deviation of unit should be within $\pm 3\text{dB}$ 經測試後, 靜置於+25 (室溫)環境中 6 小時後, 測試後無任何障礙防礙正常操作. 且在輸入 1.55V 正弦波從 Fo 到 20KHz 之間無異常音. Fo 與原規格值相同, 輸出音壓變化量在 $\pm 3\text{dB}$ 內.
2	Low temp. Test 低溫測試	After being placed in a chamber at -30 for 96 hours. 置於-30 環境中 96 小時	
3	Humidity test 相對濕度測試	After being placed in a chamber at +40 and 90 $\pm$ 5% RH relative humidity for 96 hours. 置於+40 , 相對濕度 90 $\pm$ 5%環境中 96 小時	
4	Temp. cycle test 溫度循環測試	The part shall be subjected to 5 cycles. One cycle shall be consist of: 單體承受溫度循環測試 5 次, 其循環內容如圖示: 	

## H. Recommended Temperature Profile For Hand Soldering 建議手焊溫度

Hand Soldering
370 $\pm$ 10 / 3 $\pm$ 1 Sec

# I. RELIABILITY TEST 信賴性試驗

No.	Item	Test conditions	Evaluation standard
1	Load test 連續負荷	0.3W White noise is applied for 24 hours at room temp. 在室溫下,輸入功率 0.3W, 白噪音連續操作 24 小時.	Being placed for 1 hours at +25 , speaker shall be measured. No obstacle to be harmful to normal operation; damages, cracks, rusts, etc. Should not be audible at 1.55V sine wave between Fo ~ 20KHz. Fo should meet initial one. S.P.L. deviation of unit should be within ±3dB 經測試後,靜置於+25 (室溫)環境中 1 小時後,測試後無任何障礙防礙正常操作.且在輸入 1.55V 正弦波從 Fo 到 20KHz 之間無異常音.Fo 與原規格值相同,輸出音壓變化量在±3dB 內.

## TEST CONDITION.

Standard Test Condition :	a) Temperature : +5 ~ +35	b) Humidity : 45-85%	c) Pressure : 860-1060mbar
一般測試條件 :	a) 溫度 : +5 ~ +35	b) 濕度 : 45-85%	c) 氣壓 : 860-1060mbar
Judgement Test Condition	a) Temperature : +25 ± 2	b) Humidity : 60-70%	c) Pressure : 860-1060mbar
爭議時測試條件:	a) 溫度 : +25 ± 2	b) 濕度 : 60-70%	c) 氣壓 : 860-1060mbar

## J. PACKING STANDARD 包裝規格

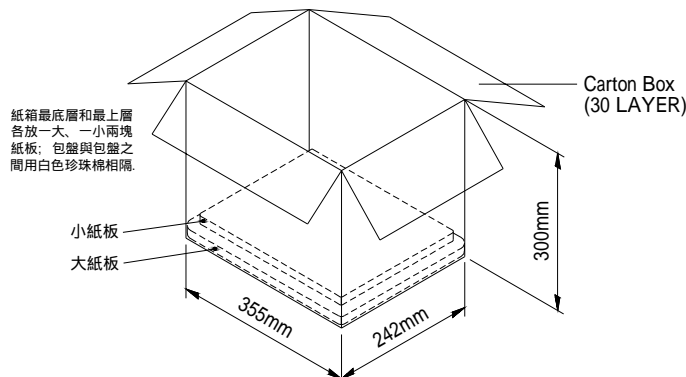
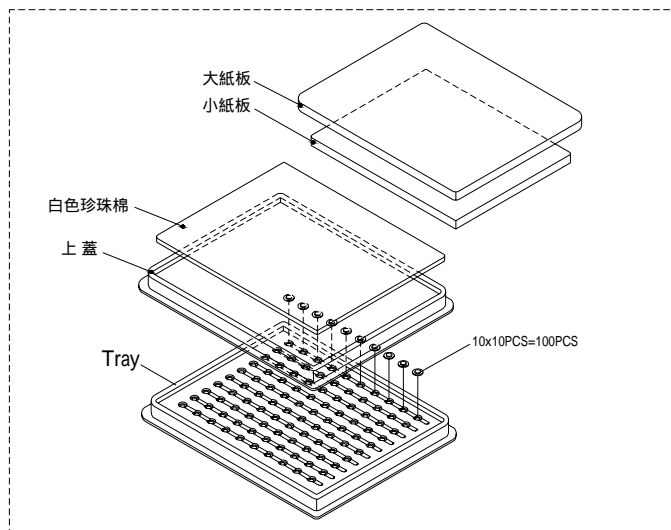

Tray	340mmx230mmx20mm	1x100PCS=100PCS
Carton Box	355mmx242mmx300mm	100PCSx30=3,000PCS