

**ProLight PACJ-28FxL-xC4N**  
**28W COB Light-Engine LEDs**  
**Technical Datasheet**  
**Version: 1.1**

# ProLight Opto ® ProEngine Series

## Features

- High flux density of lighting source
- Good color uniformity
- RoHS compliant
- Energy Star binning structure, neutral white and warm white with 2 steps guarantee.
- More energy efficient than incandescent and most halogen lamps
- No UV
- Long lifetime
- 5 year warranty

## Main Applications

- Par lighting
- LED Bulb
- Ceiling lighting
- Spot lighting
- Down lighting

## Introduction

·The input power is 28 Watt, the multi-chip ultra high power ProEngine Series delivers never before seen luminous flux output from a single emitter. The superficial illuminating nature of ProEngine makes them the preference in Par lighting, typical applications include commercial down lighting, LED bulb, accent lighting, ceiling lighting and spot lighting.

## Emitter Mechanical Dimensions

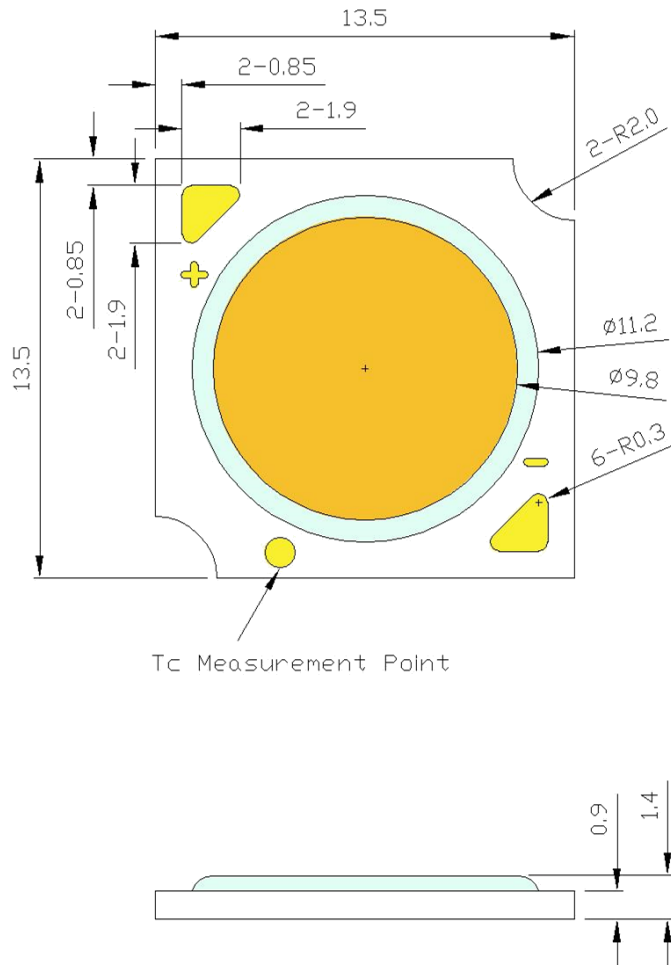

### Notes:

1. Slots in aluminum-core PCB for M3 mounting screw.
2. Solder pads are labeled "+" and "-" to denote positive and negative, respectively.
3. Drawing not to scale.
4. All dimensions are in millimeters.
5. Unless otherwise indicated, tolerances are  $\pm 0.30$ mm.
6. **Please do not use a force of over 0.3kgf impact or pressure on the lens of the LED, otherwise it will cause a catastrophic failure.**

\*The appearance and specifications of the product may be modified for improvement without notice.

## Flux Characteristics, $T_c = 25^\circ\text{C}$

Radiation Pattern	Color	Part Number COB	DC Forward Current (mA)		Luminous Flux $\Phi_v$ (lm)		CRI Min.	R9 Min.
			360*	720	Min.	Typ.		
Lambertian	White	PACJ-28FWL-AC4N	360*	720	1840	2100	70	-
					3255	3720		
	Neutral White	PACJ-28FNL-AC4N	360*	720	1800	2060	70	-
					3185	3645		
	Warm White	PACJ-28FVL-AC4N	360*	720	1720	1980	70	-
					3045	3505		
	White	PACJ-28FWL-BC4N	360*	720	1800	2060	80	0
					3185	3645		
	Neutral White	PACJ-28FNL-BC4N	360*	720	1765	2020	80	0
					3125	3575		
	Warm White	PACJ-28FVL-BC4N	360*	720	1685	1940	80	0
					2980	3435		
	White	PACJ-28FWL-DC4N	360*	720	1585	1810	90	50
					2790	3185		
	Neutral White	PACJ-28FNL-DC4N	360*	720	1550	1775	90	50
					2730	3125		
Warm White	PACJ-28FVL-DC4N	360*	720	1480	1700	90	50	
				2605	2990			
Neutral White	PACJ-28FNL-EC4N	360*	720	1365	1560	95	90	
				2400	2745			
Warm White	PACJ-28FVL-EC4N	360*	720	1300	1500	95	90	
				2290	2640			

- The mark "\*" indicated product is tested and binned at the specified drive current.
- ProLight maintains a tolerance of  $\pm 7\%$  on flux and power measurements.
- ProLight maintains a tolerance of  $\pm 2$  on CRI measurements.
- Please do not drive at rated current more than 1 second without proper heat sink.

## Electrical Characteristics at 360mA, $T_c = 25^\circ\text{C}$

Color	Forward Voltage $V_F$ (V)			Thermal Resistance Junction to Board ( $^\circ\text{C}/\text{W}$ )
	Min.	Typ.	Max.	
White	33.7	36.0	38.3	1.4
Neutral White	33.7	36.0	38.3	1.4
Warm White	33.7	36.0	38.3	1.4

- ProLight maintains a tolerance of  $\pm 1\text{V}$  for Voltage measurements.

## Optical Characteristics at 360mA, $T_c = 25^\circ\text{C}$

Color	Bin Code	Color Temperature CCT			Total included Angle (degrees) $\theta_{0.90\text{V}}$	Viewing Angle (degrees) $2\theta_{1/2}$
		Min.	Typ.	Max.		
White	V0	4740 K	5000 K	5310 K	160	120
	W0	5310 K	5700 K	6010 K	160	120
	X0	6020 K	6500 K	7030 K	160	120
Neutral White	S0	3900 K	4000 K	4070 K	160	120
	M0	2670 K	2700 K	2770 K	160	120
Warm White	N0	2990 K	3000 K	3090 K	160	120
	Q0	3380 K	3500 K	3550 K	160	120

- ProLight maintains a tolerance of  $\pm 5\%$  for CCT measurements.

## Supply Specifications

Part Number	CIR	Color Bin Code						
		V0	W0	X0	S0	M0	N0	Q0
PACJ-28F <sub>x</sub> L-AC4N	70	V			V	V		
PACJ-28F <sub>x</sub> L-BC4N	80	V	V	V	V	V	V	V
PACJ-28F <sub>x</sub> L-DC4N	90	V			V	V	V	V
PACJ-28F <sub>x</sub> L-EC4N	95				V	V	V	

## Electro-Optical Characteristics, $T_c = 25^\circ\text{C}$

$I_F$ (mA)	$V_F$ (V)	Power (W)	PACJ-28FWL-AC4N		PACJ-28FNL-AC4N		PACJ-28FVL-AC4N	
			Flux (lm)	lm/W	Flux (lm)	lm/W	Flux (lm)	lm/W
240	34.63	8.31	1560	187.7	1532	184.3	1472	177.1
360*	36.00	12.96	2100	162.0	2060	159.0	1980	152.8
480	37.23	17.87	2640	147.7	2588	144.8	2488	139.2
600	38.42	23.05	3180	138.0	3117	135.2	2996	130.0
720	39.53	28.46	3720	130.7	3645	128.1	3505	123.1
$I_F$ (mA)	$V_F$ (V)	Power (W)	PACJ-28FWL-BC4N		PACJ-28FNL-BC4N		PACJ-28FVL-BC4N	
			Flux (lm)	lm/W	Flux (lm)	lm/W	Flux (lm)	lm/W
240	34.63	8.31	1532	184.3	1502	180.7	1442	173.5
360*	36.00	12.96	2060	159.0	2020	155.9	1940	149.7
480	37.23	17.87	2588	144.8	2538	142.1	2438	136.4
600	38.42	23.05	3117	135.2	3057	132.6	2937	127.4
720	39.53	28.46	3645	128.1	3575	125.6	3435	120.7
$I_F$ (mA)	$V_F$ (V)	Power (W)	PACJ-28FWL-DC4N		PACJ-28FNL-DC4N		PACJ-28FVL-DC4N	
			Flux (lm)	lm/W	Flux (lm)	lm/W	Flux (lm)	lm/W
240	34.63	8.31	1352	162.7	1325	159.4	1270	152.8
360*	36.00	12.96	1810	139.7	1775	137.0	1700	131.2
480	37.23	17.87	2268	126.9	2225	124.5	2130	119.2
600	38.42	23.05	2727	118.3	2675	116.1	2560	111.1
720	39.53	28.46	3185	111.9	3125	109.8	2990	105.1
$I_F$ (mA)	$V_F$ (V)	Power (W)	PACJ-28FNL-EC4N		PACJ-28FVL-EC4N			
			Flux (lm)	lm/W	Flux (lm)	lm/W		
240	34.63	8.31	1165	140.2	1120	134.8		
360*	36.00	12.96	1560	120.4	1500	115.7		
480	37.23	17.87	1955	109.4	1880	105.2		
600	38.42	23.05	2350	102.0	2260	98.0		
720	39.53	28.46	2745	96.5	2640	92.8		

● All values are reference only.

## Absolute Maximum Ratings

Parameter	White/Neutral White/Warm White
Max DC Forward Current (mA)	720
Max Voltage at 720mA	42
Peak Pulsed Forward Current (mA)	1080 (less than 1/10 duty cycle@1KHz)
ESD Sensitivity (HBM per MIL-STD-883E Method 3015.7)	±2000V
LED Junction Temperature	120°C
Operating Board Temperature at Maximum DC Forward Current	-40°C - 90°C
Storage Temperature	-40°C - 120°C
Reverse Voltage	Not designed to be driven in reverse bias

## Color Bin

### White Binning Structure Graphical Representation

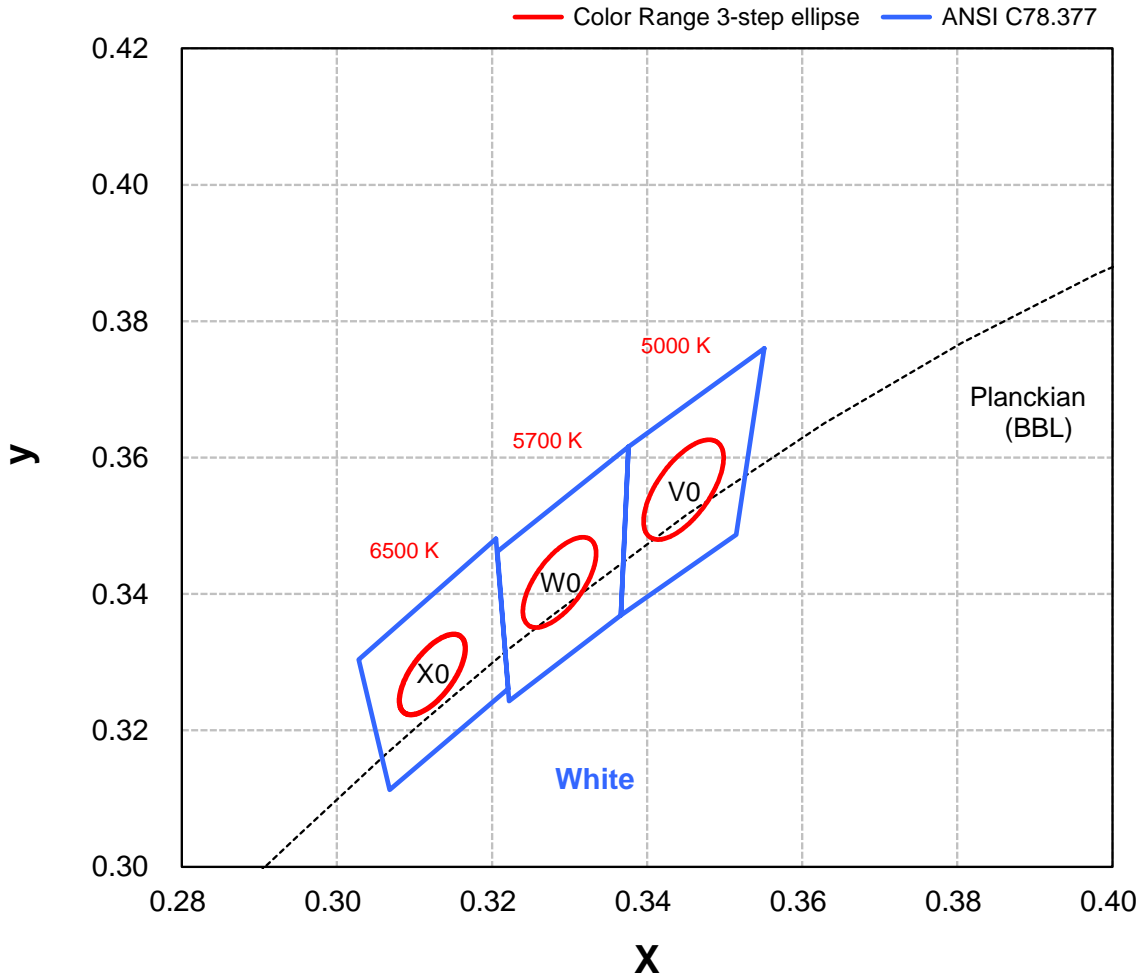

#### White Bin Structure

Bin Code	Center	Oval parameter	Typ. CCT (K)	Bin Code	Center	Oval parameter	Typ. CCT (K)
V0	x	a	5000	X0	x	a	6500
	y	b			y	B	
		e°				e°	
W0	x	a	5700				
	y	B					
		e°					

- Color range stay within MacAdam “3-step” ellipse from the chromaticity center.
- The chromaticity center refers to ANSI C78.377.
- Tolerance on each color bin (x , y) is  $\pm 0.005$

## Color Bin

### Neutral White Binning Structure Graphical Representation

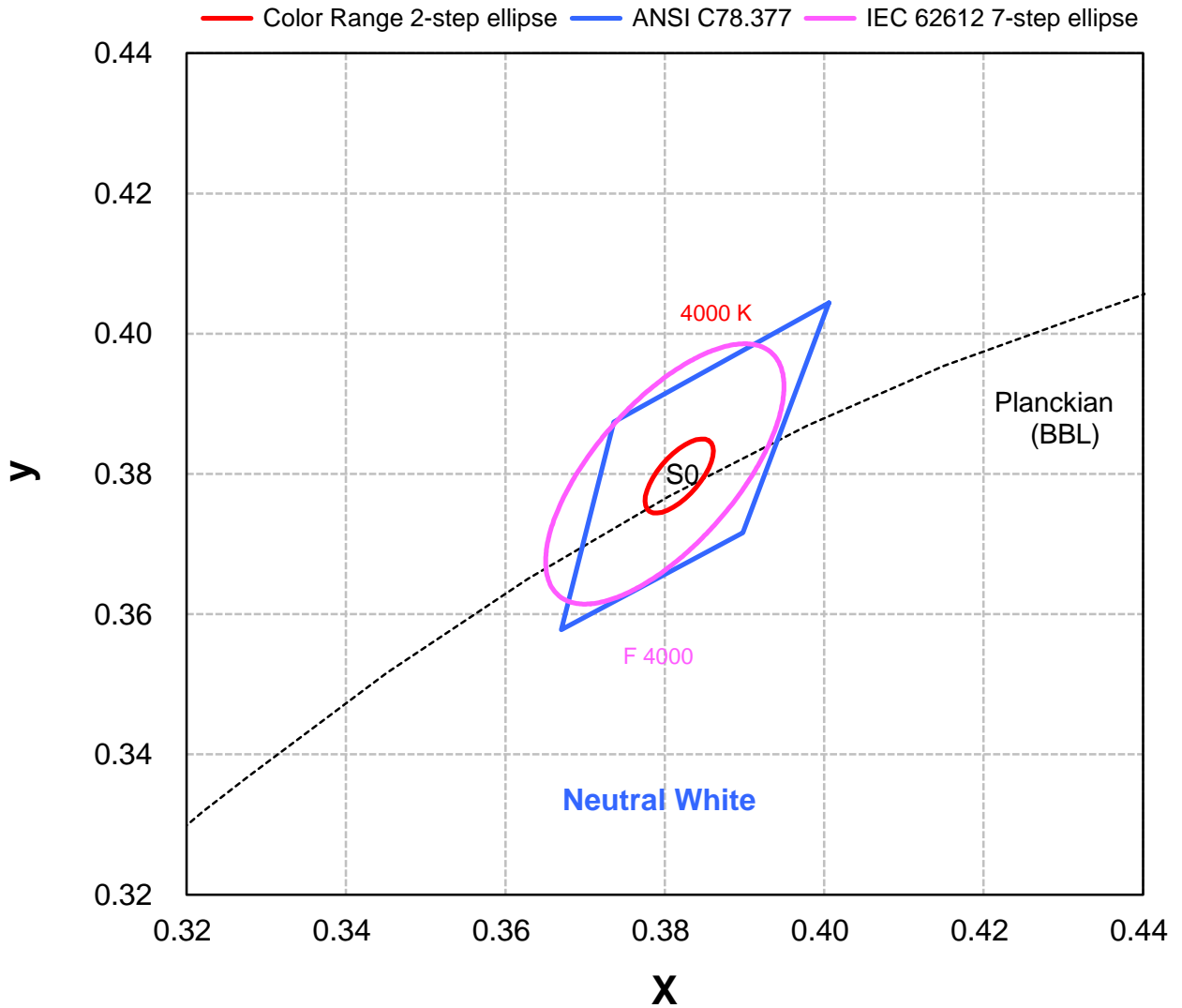

#### Neutral White Bin Structure

Bin Code	Center	Oval parameter	Typ. CCT (K)
S0	x	0.3818	4000
	y	0.3797	
	a	0.00626	
	b	0.00268	
		e°	53.72

- Color range stay within MacAdam "2-step" ellipse from the chromaticity center.
- The chromaticity center refers to ANSI C78.377.
- Tolerance on each color bin (x , y) is  $\pm 0.005$



## Color Bin

### Warm White Binning Structure Graphical Representation

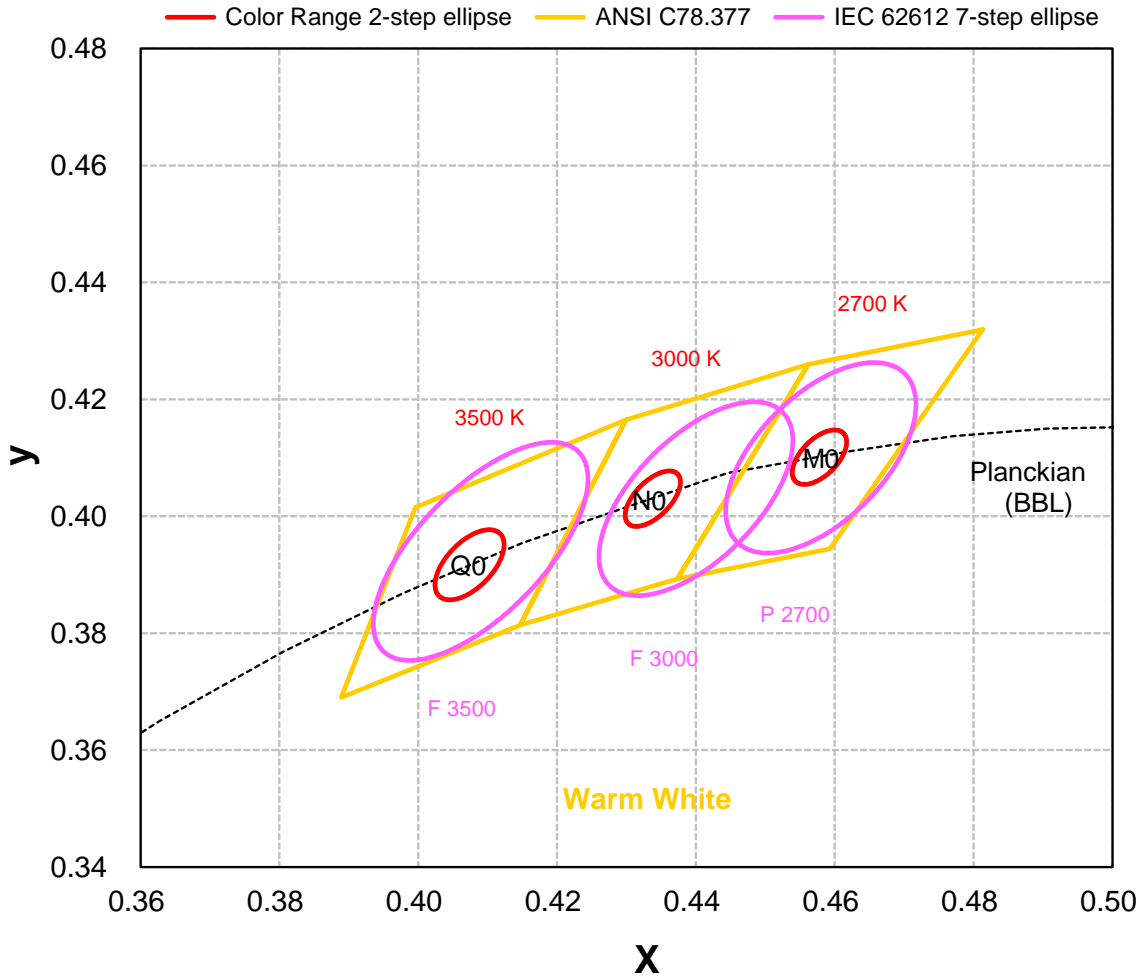

#### Warm White Bin Structure

Bin Code	Center	Oval parameter	Typ. CCT (K)	Bin Code	Center	Oval parameter	Typ. CCT (K)
M0	x	a	2700	Q0	x	a	3500
	y	b			y	b	
	e°	e°					
N0	x	a	3000	Q0	x	a	3500
	y	b			y	b	
	e°	e°					

- Color range stay within MacAdam “2-step” ellipse from the chromaticity center.
- The chromaticity center refers to ANSI C78.377.
- Tolerance on each color bin (x , y) is  $\pm 0.005$

## Color Spectrum, $T_c = 25^\circ\text{C}$

1. PACJ-21WL-AC4N 、 PACJ-28FNL-AC4N 、 PACJ-28FVL-AC4N

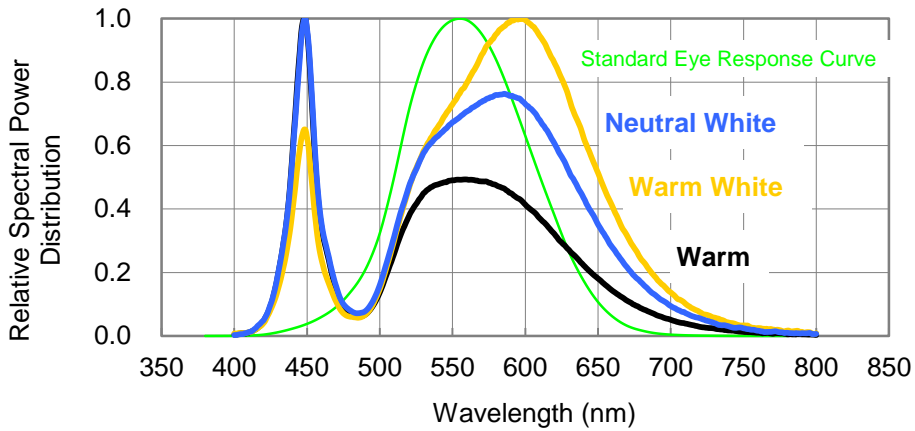

2. PACJ-28FWL-BC4N 、 PACJ-28FNL-BC4N 、 PACJ-28FVL-BC4N

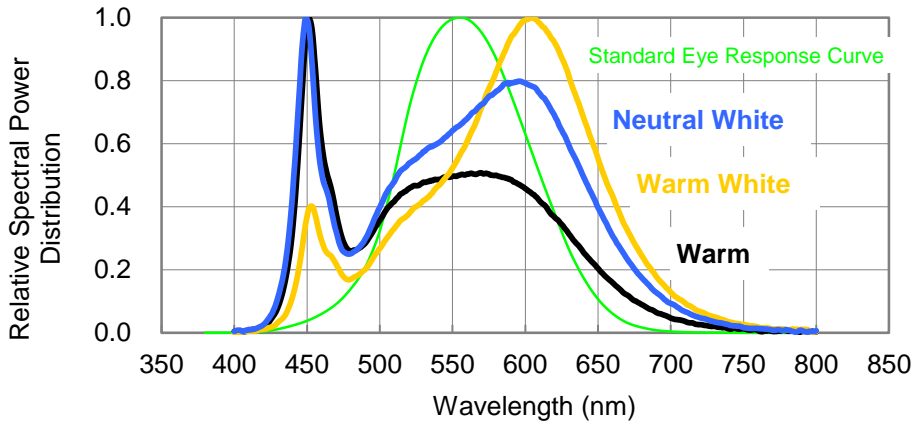

## Color Spectrum, $T_c = 25^\circ\text{C}$

3. PACJ-28FWL-DC4N 、 PACJ-28FNL-DC4N 、 PACJ-28FVL-DC4N

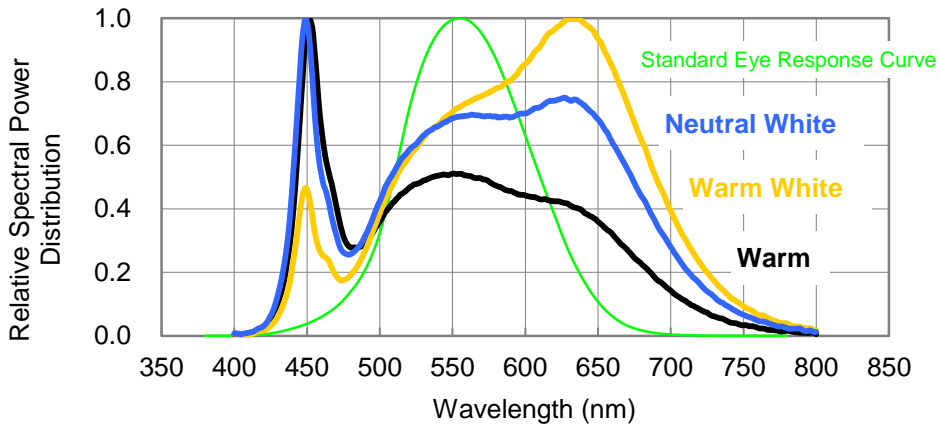

4. PACJ-28FNL-EC4N 、 PACJ-28FVL-EC4N

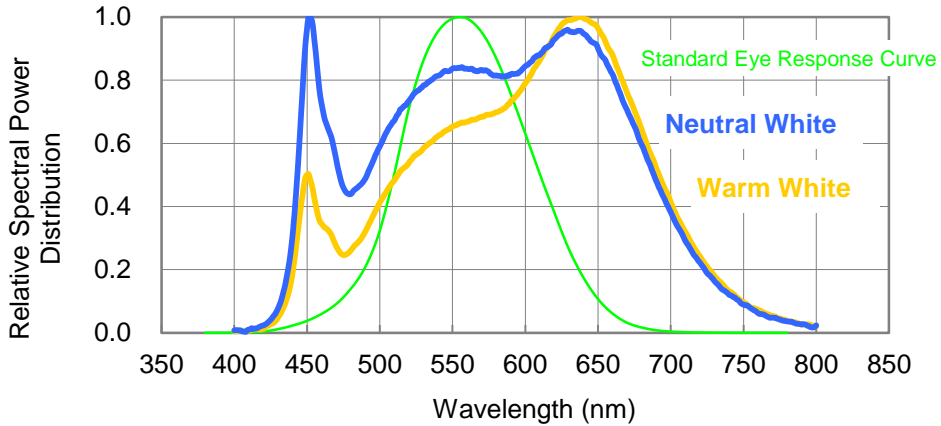

## Case Temperature Relative Characteristics

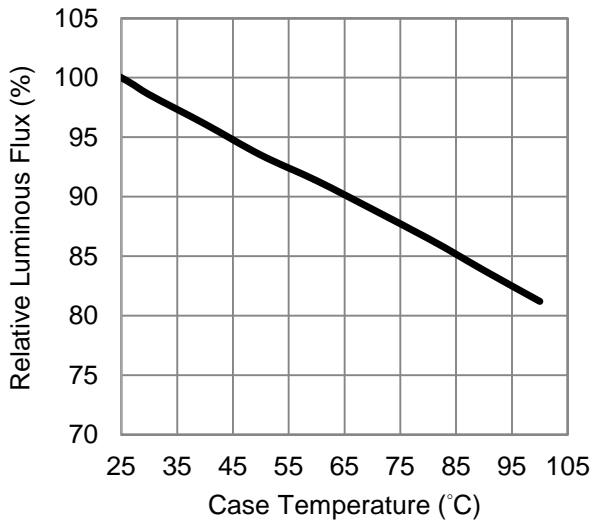

Fig 1. Case Temperature vs. Relative Luminous Flux at 360mA.

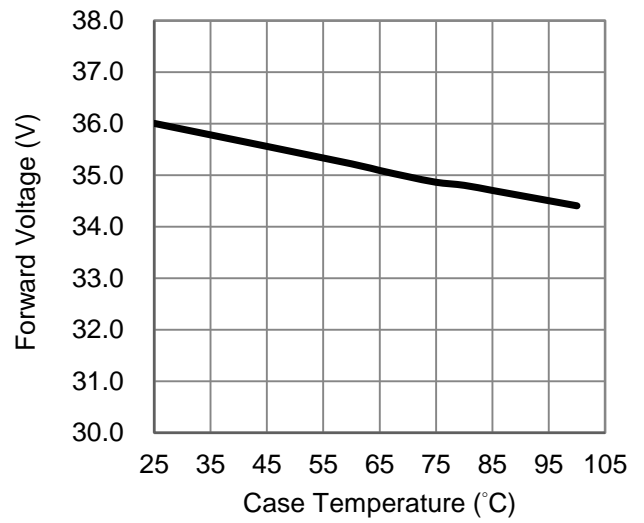

Fig 2. Case Temperature vs. Forward Voltage at 360mA.

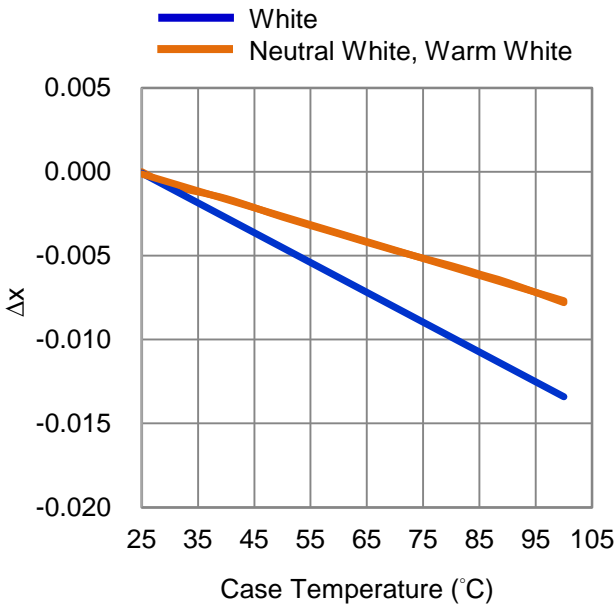

Fig 3. Case Temperature vs. Chromaticity Coordinate  $\Delta x$  at 360mA.

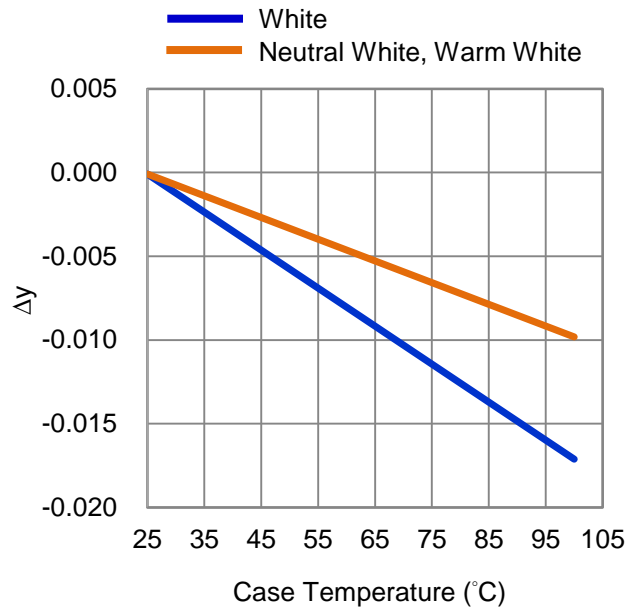

Fig 4. Case Temperature vs. Chromaticity Coordinate  $\Delta y$  at 360mA.

## Forward Current Relative Characteristics

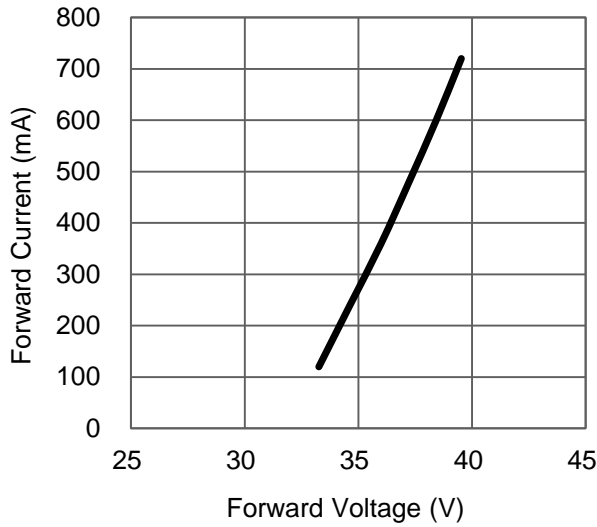

Fig 5. Forward Current vs. Forward Voltage at  $T_C=25^\circ\text{C}$ .

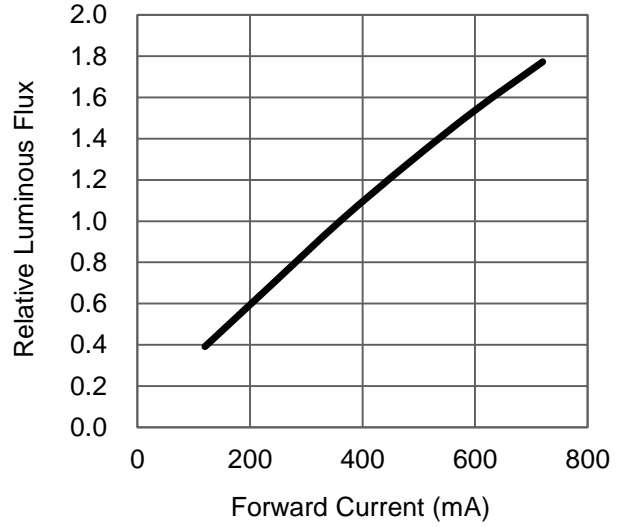

Fig 6. Forward Current vs. Relative Luminous Flux at  $T_C=25^\circ\text{C}$ .

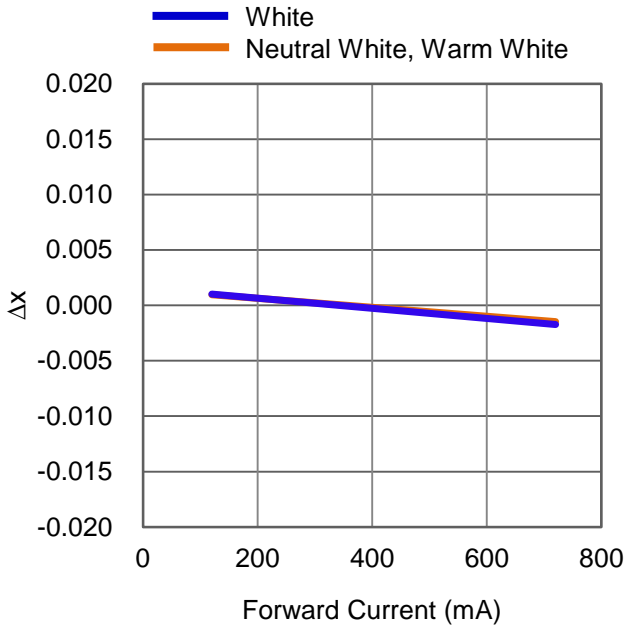

Fig 7. Forward Current vs. Chromaticity Coordinate  $\Delta x$  at  $T_C=25^\circ\text{C}$ .

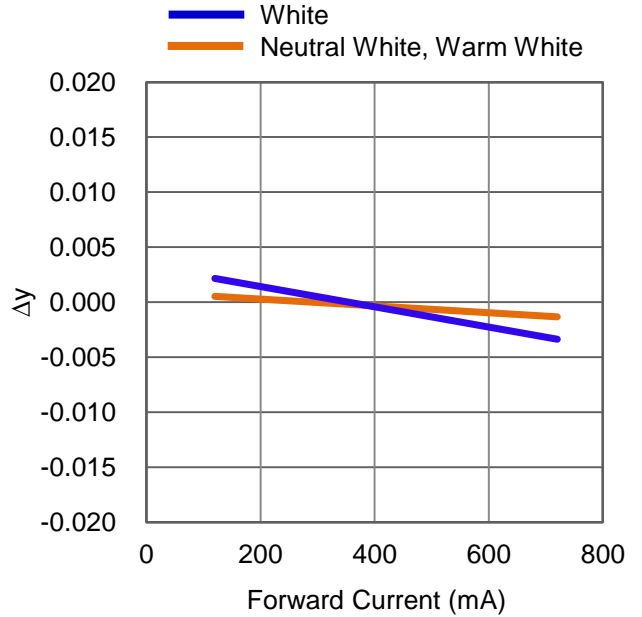

Fig 8. Forward Current vs. Chromaticity Coordinate  $\Delta y$  at  $T_C=25^\circ\text{C}$ .

## Case Temperature vs. Junction Temperature Characteristics

T <sub>c</sub> (°C)	T <sub>j</sub> (°C)	
	360 (mA)	720 (mA)
0	18	40
5	23	45
10	28	50
15	33	55
20	38	60
25	43	65
30	48	70
35	53	75
40	58	80
45	63	85
50	68	90
55	73	95
60	78	100
65	83	105
70	88	110
75	93	115
80	98	120

Fig 9. Case Temperature vs. Junction Temperature at 360 ∙ 720mA.

## Color Coordinate vs. Forward Current, $T_c = 25^\circ\text{C}$

### White Binning Graphical Representation

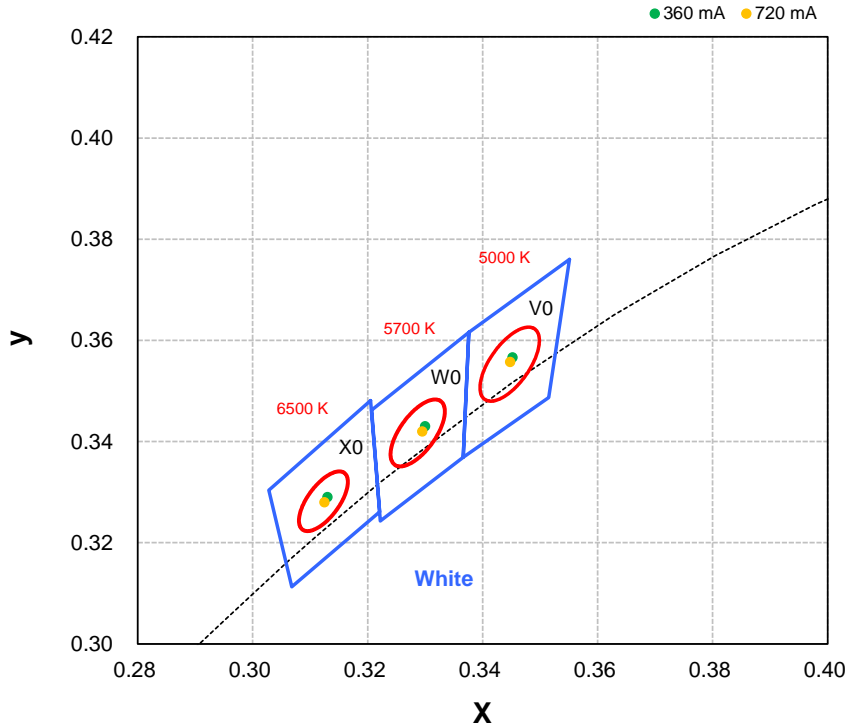

### Neutral White Binning Graphical Representation

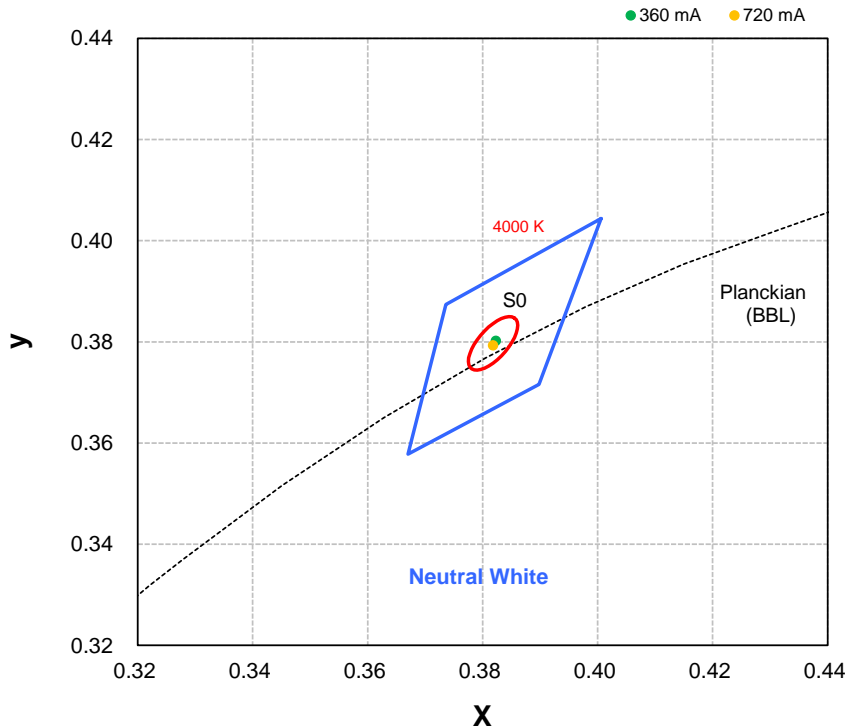

## Color Coordinate vs. Forward Current, $T_c = 25^\circ\text{C}$

### Warm White Binning Graphical Representation

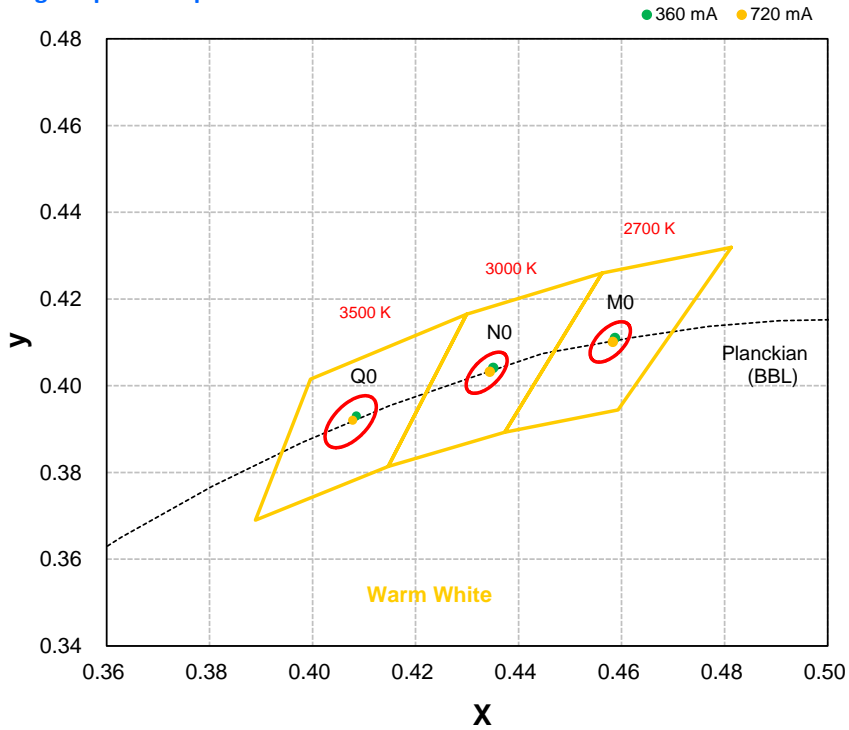



# Typical Representative Spatial Radiation Pattern

## Lambertian Radiation Pattern

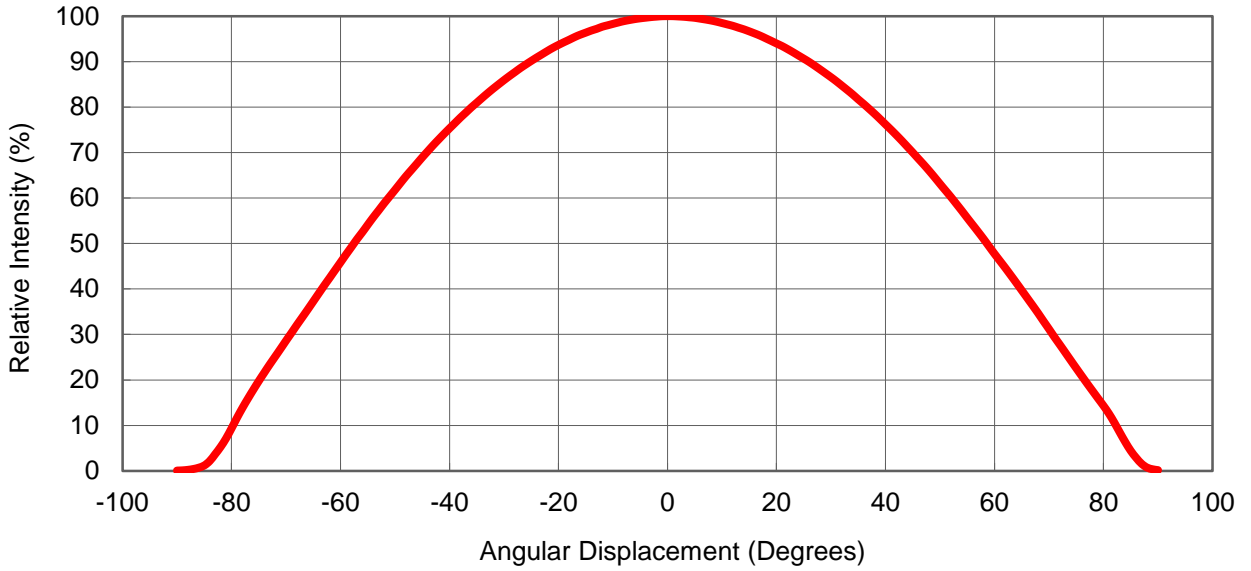

## Polar Radiation Pattern

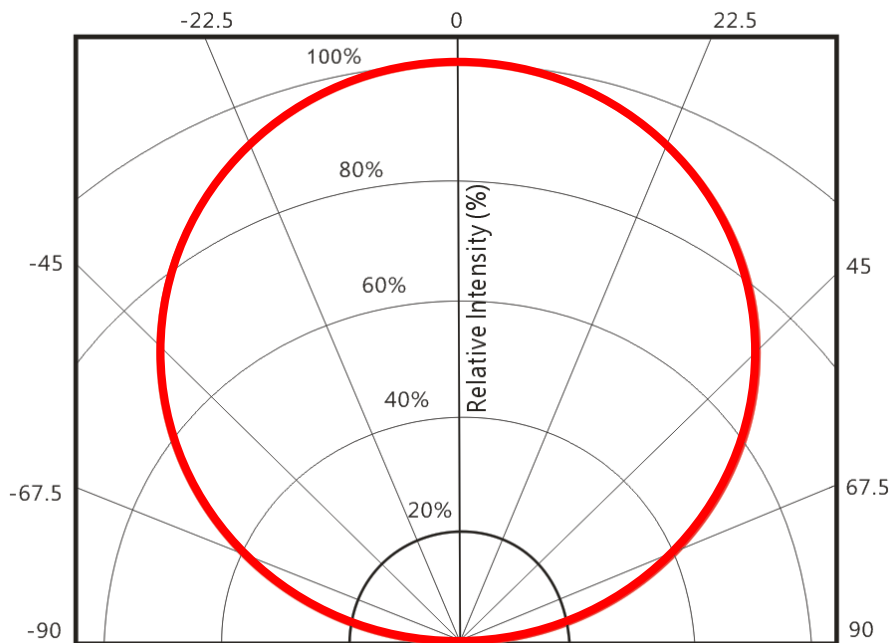

## Packing Specifications

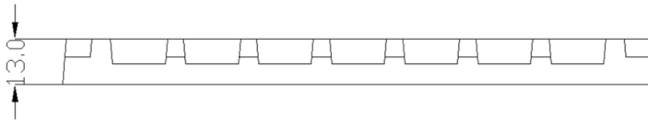
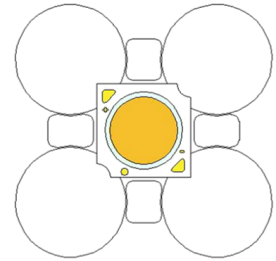
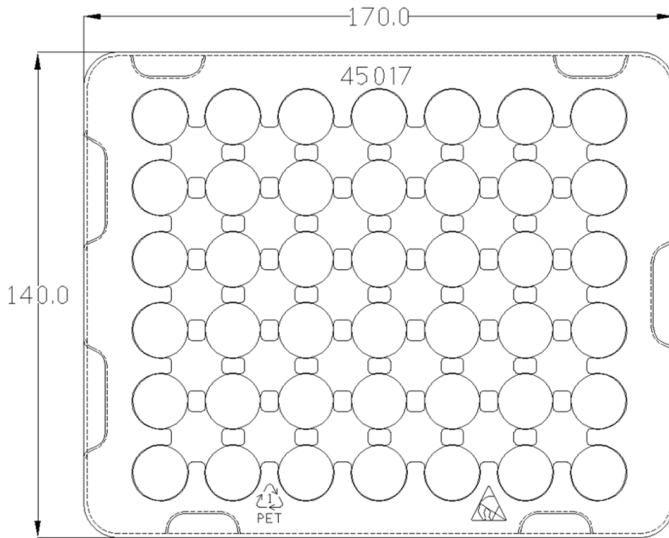

Product 30 pcs/tray

**Notes:**

1. Drawing not to scale.
2. All dimensions are in millimeters.
3. Unless otherwise indicated, tolerances are  $\pm 0.20\text{mm}$ .

## Assembly note

Regarding the high power density of LED Array, it is strongly recommend to use thermal grease and screws.

In order to reduce thermal resistance at assembly, it is necessary to use TIM (thermal interface Material) uniformly and tighten screws on heatsink, otherwise the bad thermal resistance may cause the packages **burned out**.

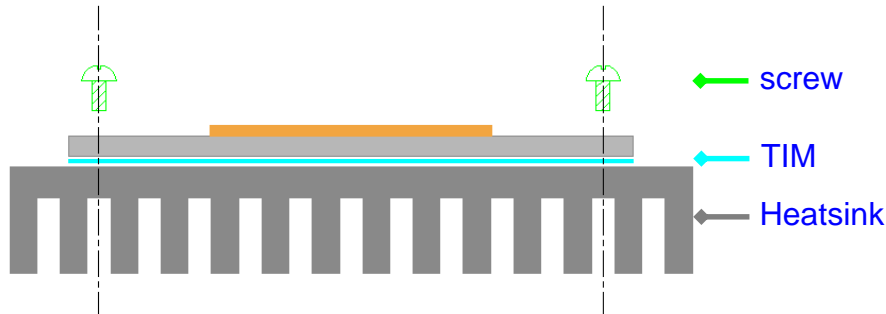

Fig 10. Reference assembly as fixing with screws

## Limited Warranty : COB Light Engine Series

This limited warranty is provided by ProLight Opto described below (“Seller”) to you as the original purchaser of the LED lighting product that is identified on Seller’s invoice reflecting its original purchase (the “Product”). We warrant the identification as such on the invoice, will be free of defects in material and workmanship for a period of five (5) YEARS from the date of original purchase. This limited warranty excludes field labor and service charges related to the repair or replacement of the Product. Seller’s aggregate liability with respect to a defective product shall in any event be limited to the monies paid to seller for that defective product. The determination of whether the Product is defective shall be made by Seller in its sole discretion with consideration given to the overall performance of the Product. This limited warranty cannot be transferred to subsequent purchasers of the Product, provided that such Product is resold in new condition and in its original packaging. This limited warranty is void if the product is not used for the purpose for which it is designed.

## Recommended Soldering Condition

- Please use lead free and “no clean ” solders.
- Soldering shall be implemented using a soldering tip at a temperature lower than 350 °C, and shall be finished within 3.5 seconds for each pad.
- During the soldering process, put the LEDs on materials whose conductivity is poor enough not to radiate heat of soldering.
- Properly solder tin wires before soldering them to LEDs.
- Avoid touching the silicone lens with the soldering iron.
- Please prevent flux from touching to the silicone lens.
- Please solder evenly on each pad.
- Contacts number of a soldering tip should be within twice for each pad.
- Next process of soldering should be carried out after the LEDs have return to ambient temperature.

\*ProLight cannot guarantee if usage exceeds these recommended conditions.

Please use it after sufficient verification is carried out on your own risk if absolutely necessary.

## Precaution for Use

- The modules light output are intense enough to cause injury to human eyes if viewed directly. Precautions must be taken to avoid looking directly at the modules with unprotected eyes.
- The modules are sensitive to electrostatic discharge. Appropriate ESD protection measures must be taken when working with the modules. Non-compliance with ESD protection measures may lead to damage or destruction of the product.
- Chemical solvents or cleaning agents must not be used to clean the modules. Mechanical stress on the Emitters must be avoided. It is best to use a soft brush, damp cloth or low-pressure compressed air.
- The products should be stored away from direct light in dry location.
- The appearance, specifications and flux bin of the product may be modified for improvement without notice. Please refer to the below website for the latest datasheets.  
<http://www.prolightopto.com/>

## Handling of Silicone Lens LEDs

Notes for handling of silicone lens LEDs

- Please do not use a force of over 0.3kgf impact or pressure on the silicone lens, otherwise it will cause a catastrophic failure.
- Avoid touching the silicone lens and the optical area of the COB Array especially by sharp tools such as Tweezers
- Avoid touching the silicone lens especially by sharp tools such as Tweezers.
- Avoid leaving fingerprints on the silicone lens.
- Please store the LEDs away from dusty areas or seal the product against dust.
- Please do not mold over the silicone lens with another resin. (epoxy, urethane, etc)

