

SOT-23 Plastic-Encapsulate Transistors

FEATURES

- As complementary type, the NPN transistor TKMMBT3904 is Recommended
- Epitaxial planar die construction

MARKING: 2A

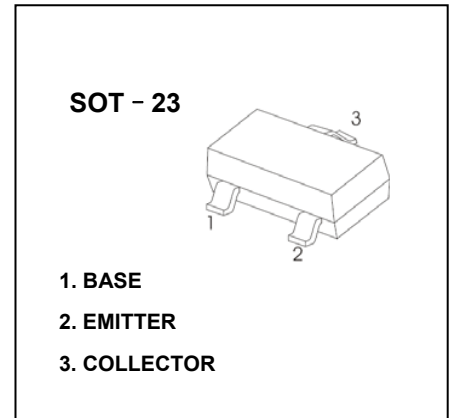

MAXIMUM RATINGS (T_A=25°C unless otherwise noted)

Symbol	Para meter	Value	Unit
V _{CBO}	Collector-Base Voltage	-40	V
V _{CEO}	Collector-Emitter Voltage	-40	V
V _{EBO}	Emitter-Base Voltage	-5	V
I _C	Collector Current -Continuous	-0.2	A
P _C	Collector Dissipation	0.2	W
R _{θJA}	Thermal resistance junction to ambient	625	°C/W
T _J	Junction Temperature	150	°C
T _{stg}	Storage Temperature	-55~+150	°C

ELECTRICAL CHARACTERISTICS (T_{amb}=25°C unless otherwise specified)

Parameter	Symbol	Test conditions	MIN	MAX	UNIT
Collector-base breakdown voltage	V _{(BR)CBO}	I _C =-10μA, I _E =0	-40		V
Collector-emitter breakdown voltage	V _{(BR)CEO}	I _C = -1mA, I _B =0	-40		V
Emitter-base breakdown voltage	V _{(BR)EBO}	I _E = -10μA, I _C =0	-5		V
Collector cut-off current	I _{CBO}	V _{CB} = -40 V, I _E =0		-100	nA
Collector cut-off current	I _{CEX}	V _{CE} =-30V, V _{BE(off)} =-3V		-50	nA
Emitter cut-off current	I _{EBO}	V _{EB} = -5V, I _C =0		-100	nA
DC current gain	h _{FE1}	V _{CE} =-1V, I _C = -10mA	100	300	
	h _{FE2}	V _{CE} = -1V, I _C =-50mA	60		
	h _{FE3}	V _{CE} = -2V, I _C =-100mA	30		
Collector-emitter saturation voltage	V _{CE(sat)1}	I _C =-50mA, I _B =-5mA		-0.3	V
Base-emitter saturation voltage	V _{BE(sat)}	I _C = -50mA, I _B =-5mA		-0.95	V
Transition frequency	f _T	V _{CE} =-20V, I _C =-10mA, f=100MHz	300		MHz
Delay Time	t _d	V _{CC} =-3V, V _{BE} =-0.5V I _C =-10mA, I _{B1} =I _{B2} =-1mA		35	nS
Rise Time	t _r			35	nS
Storage Time	t _s	V _{CC} =-3V, I _C =-10mA I _{B1} =I _{B2} =-1mA		225	nS
Fall Time	t _f			75	nS

CLASSIFICATION OF h_{FE(1)}

HFE	100-300
-----	---------

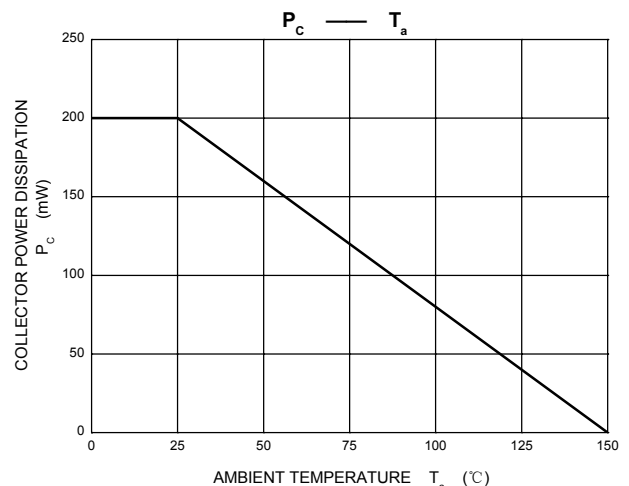
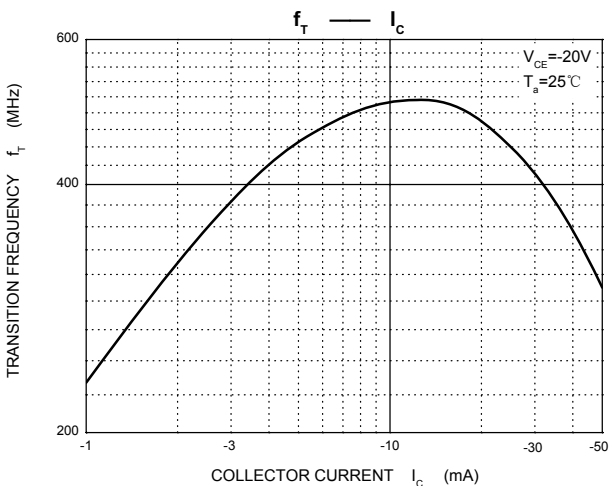
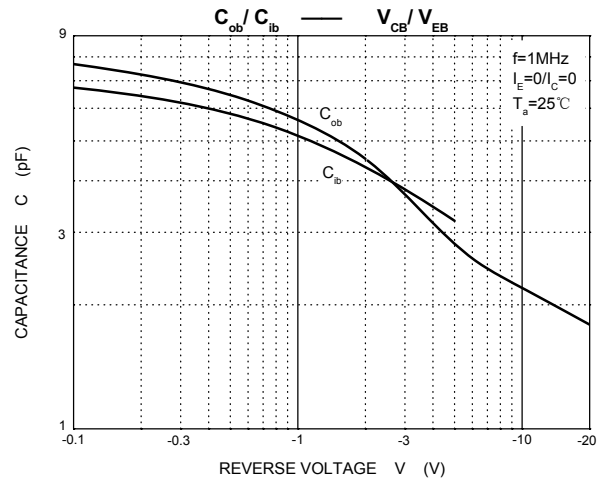
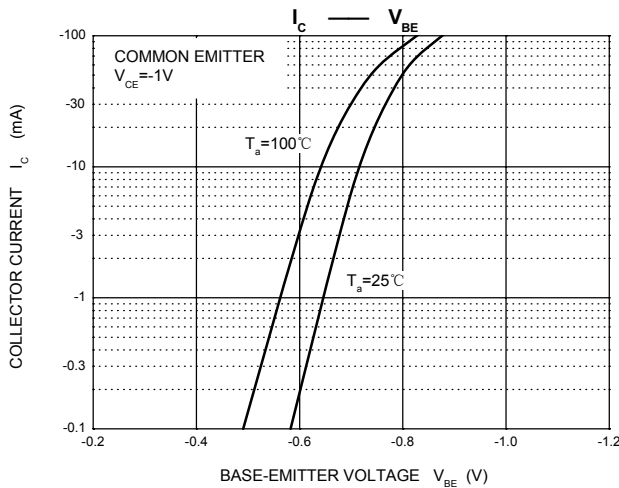
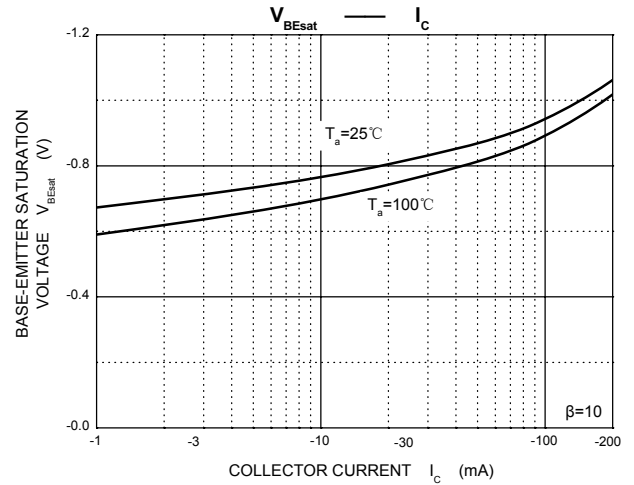
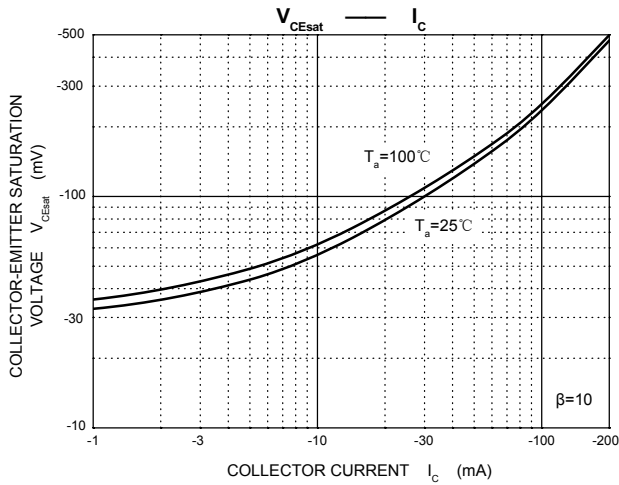
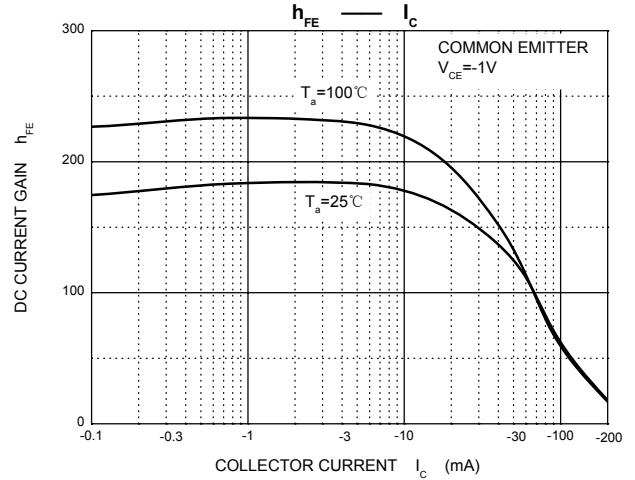
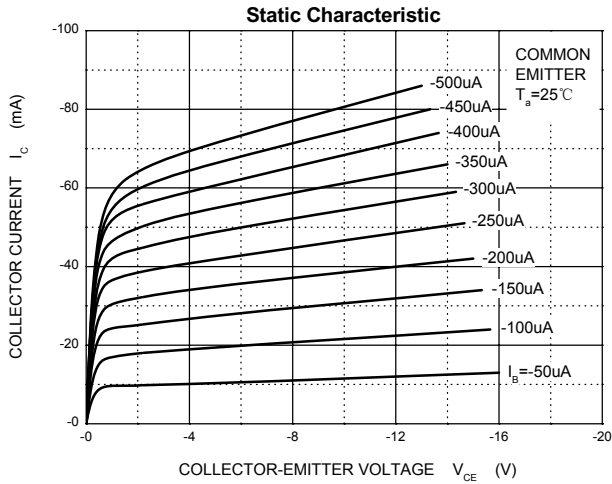

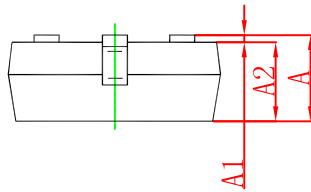
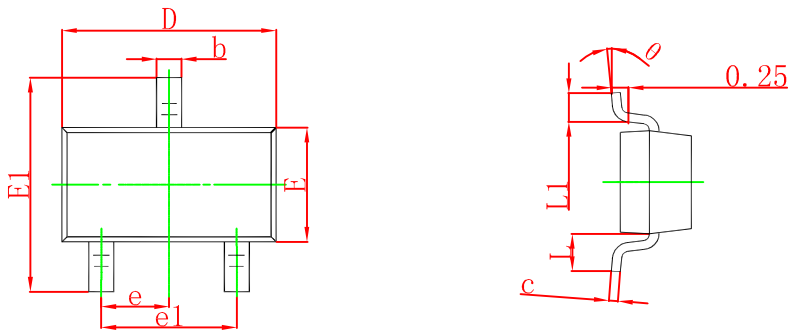

Symbol	Dimensions In Millimeters		Dimensions In Inches	
	Min	Max	Min	Max
A	0.900	1.150	0.035	0.045
A1	0.000	0.100	0.000	0.004
A2	0.900	1.050	0.035	0.041
b	0.300	0.500	0.012	0.020
c	0.080	0.150	0.003	0.006
D	2.800	3.000	0.110	0.118
E	1.200	1.400	0.047	0.055
E1	2.250	2.550	0.089	0.100
e	0.950 TYP		0.037 TYP	
e1	1.800	2.000	0.071	0.079
L	0.550 REF		0.022 REF	
L1	0.300	0.500	0.012	0.020
θ	0°	8°	0°	8°

SOT-23 Suggested Pad Layout

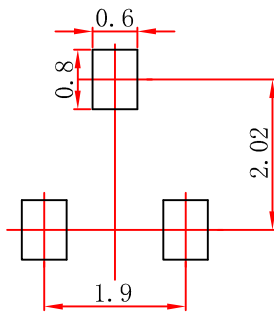

- Note:
1. Controlling dimension: in millimeters.
 2. General tolerance: $\pm 0.05\text{mm}$.
 3. The pad layout is for reference purposes only.