

RECOMMENDED  
PANEL CUT OUT

RoHS  
IP66~68

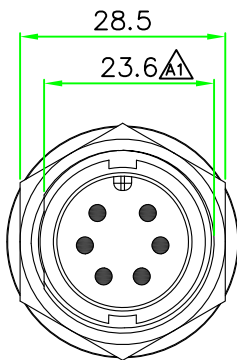

FRONT VIEW  
(前視圖)

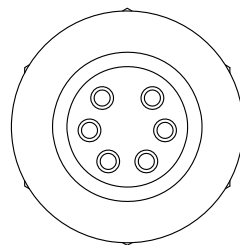
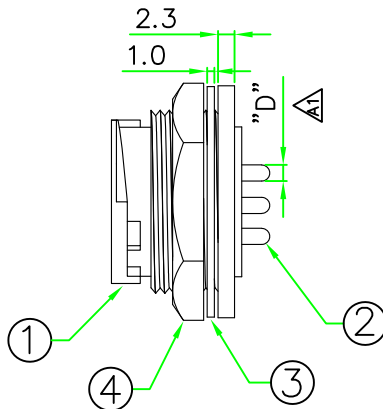
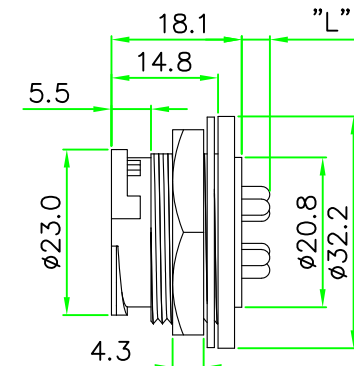

REAR VIEW  
(後視圖)

P/N	L	D
CDG	3.9	φ2.25
CDD	3.7	φ1

REV.	DESCRIPTION	DATE
A	ISSUE	Feb/02/2018
A1	Correct Dimension & Note.	Feb/12/2019

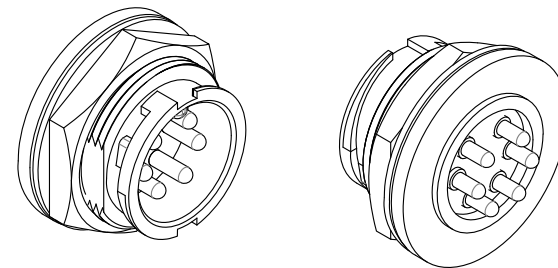

NOTES:

- ELECTRICAL CHARACTERISTICS:  
CURRENT RATING: 5A / 20A  
CONNECTOR TEMPERATURE RANGE: -25°C TO +85°C  
DIELECTRIC WITHSTANDING VOLTAGE:  
500V AC FOR ONE MINUTE
- PANEL THICKNESS MAX. 4.0mm
- HOW TO ORDER: CDx-L1xxCPR  $\Delta 1$

- 02 - 2 PIN 03 - 3 PIN
- 04 - 4 PIN 05 - 5 PIN
- 06 - 6 PIN 07 - 7 PIN
- 18 - 18 PIN

- G - CURRENT RATING 20A
- D - CURRENT RATING 5A

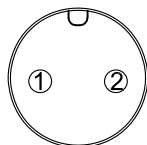

CDG-L102CPR

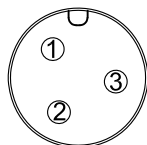

CDG-L103CPR

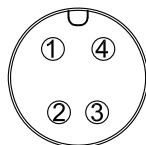

CDG-L104CPR

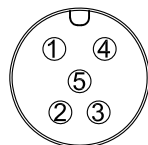

CDG-L105CPR

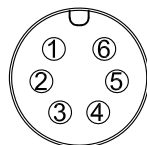

CDG-L106CPR

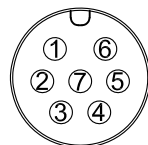

CDG-L107CPR

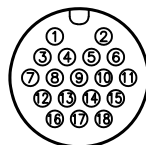

CDD-L118CPR

PIN ASSIGNMENT FRONT VIEW  
(前視圖)

4	HEX NUT	Nylon+GF.	BLACK	1	$\Delta 1$
3	GASKET	EPDM.	BLACK	1	
2	CONTACT	Brass, 6 u" Gold Plated. Male Contact.		N	
1	CONNECTOR	D Size Male Connector Insert. Nylon+GF.	BLACK	1	
No.	PART NAME	DESCRIPTION	COLOR	Q'TY	REMARKS

**HOLIN**® HTP ASIA TECHNOLOGY CO., LTD.  
禾凌科技股份有限公司

$\phi$	UNIT: mm	TITLE :	D Size Male Connector Rear Mount Lock Type Circular Flange PCB Mount Pin
SCALE	1:1	P/N:	CDx-L1xxCPR
UNLESS OTHERWISE SPECIFIED TOLERANCES:		DR.	SIBYL
.x ± 0.25 .xx ± 0.1		CH.	ERIC
.xxx ± 0.05 ANGLE ± 1°		AP.	
REV.	SHEET	DWG.NO:	CDx-L1xxCPR
A1	1/2		

RoHS

IP66~68

REV.	DESCRIPTION	DATE
A	ISSUE	Feb/02/2018
A1	Correct Dimension & Note.	Feb/12/2019

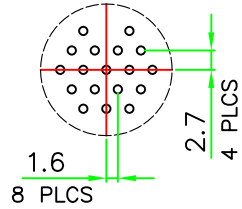

CDD-L118CPR

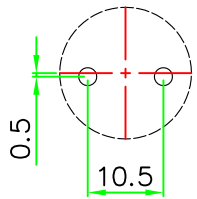

CDG-L102CPR

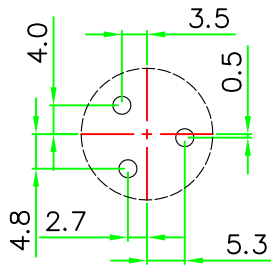

CDG-L103CPR

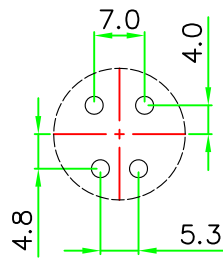

CDG-L104CPR

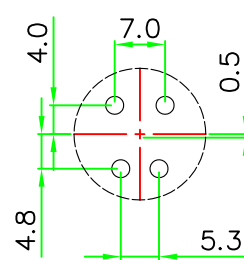

CDG-L105CPR

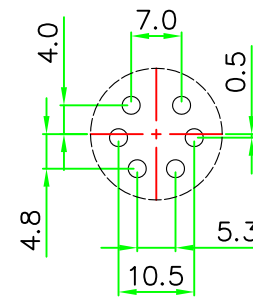

CDG-L106CPR

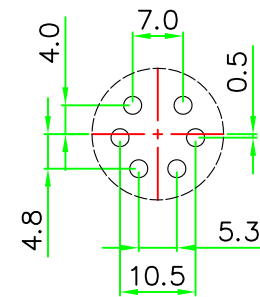

CDG-L107CPR

PCB LAYOUT

HOLIN® HTP ASIA TECHNOLOGY CO., LTD. 禾凌科技股份有限公司

	UNIT: mm	TITLE : D Size Male Connector Rear Mount Lock Type Circular Flange PCB Mount Pin	
SCALE	1:1		
UNLESS OTHERWISE SPECIFIED TOLERANCES: .x ± 0.25 .xx ± 0.1 .xxx ± 0.05 ANGLE ± 1°		P/N: CDx-L1xxCPR	DR. SIBYL
REV. A1	SHEET 2/2	DWG.NO: CDx-L1xxCPR	CH. ERIC
			AP.