

LDZY® 蓝雁®

LDZY® 蓝雁®

CONNECTOR &  
CABLE ASSEMBLY

连接器 & 线束

www.ldzyconn.com

诚信、利他、感恩、和谐；敬天爱人，知行合一 Integrity, Altruism, Gratitude, Harmony

东莞市蓝雁电子有限公司  
DONGGUAN LDZY ELECTRONICS CO.,LTD.

地址：广东省东莞市虎门镇富岗社区富兴二路3号  
Add: No. 3 Yanxing 2nd road, Yan'gang Community,  
Humen Town, Dongguan City, China  
Tel: (86-769)8532 6988 / 8532 7562 / 8532 7667  
Fax: (86-769)8532 7563 / 8537 7315  
E-mail: sales@ldzy.hk Web: www.ldzyconn.com



2024版

LDZY® 蓝雁® 连接器及线束有限公司 DONGGUAN LDZY ELECTRONICS CO.,LTD.

CONNECTOR & CABLE ASSEMBLY 连接器及线束

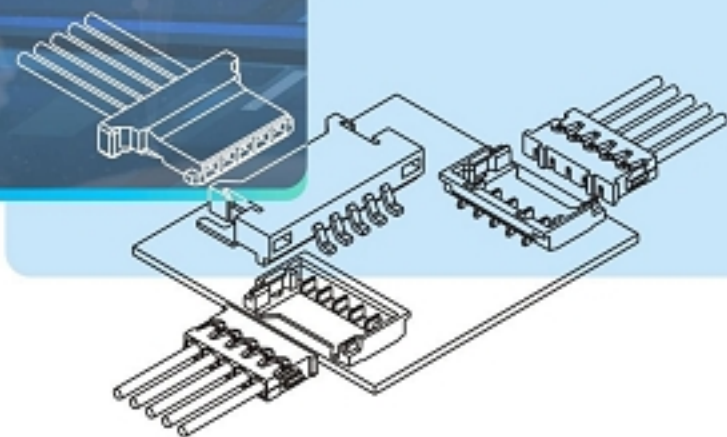

东莞市蓝雁电子有限公司  
DONGGUAN LDZY ELECTRONICS CO.,LTD.





## COMPANY PROFILE

### 公司简介

东莞市蓝雁电子有限公司创立于2010年，工厂坐落于广东省东莞市，是一家专注于电子连接器和定制线束，集开发、设计、生产、销售于一体的高新技术、专精特新企业。

产品主要有线对板、线对线、板对板连接器和定制线束，产品广泛用于汽车、动车、无人机、医疗器械、安防、自动化、办公设备、家用电器等领域，多项产品均通过美国UL、加拿大CSA、德国TUV等安全认证标准及ROHS欧盟绿色环保认证。

公司严格执行 ISO9001, ISO14001 以及 IATF16949 质量保证体系，确保我们产品拥有极高的品质。为了紧跟市场需求，我们不断推出高新技术，高质量的产品，努力打造LDZY-蓝雁品牌连接器。

为客户提供高品质的产品，优质的服务，及时的交货以及具有竞争力的价格是我司为了提高客户竞争力的承诺。

Dongguan LDZY Electronics Co., Ltd. was established in 2010, with its factory located in Dongguan City, Guangdong Province. LDZY is a high-tech and specialized enterprise that focuses on electronic connectors and custom cable assemblies, integrating development, design, production, and sales.

Our main products include wire-to-board connectors, wire-to-wire connectors, board-to-board connectors, and custom cable assemblies. These products are widely used in various fields such as automotive, trains, drones, medical devices, security, automation, office equipment, and household appliances. Many of our products have obtained safety certifications such as UL in the United States, CSA in Canada, TUV in Germany, and ROHS European environmental protection certification.

We strictly adheres to quality assurance systems like ISO 9001, ISO 14001, and IATF 16949 to ensure that our products meet the highest quality standards. In order to meet market demands, we continuously introduce advanced technology and high-quality products, striving to build the LDZY brand of connectors.

Our commitment is to provide customers with high-quality products, excellent service, timely delivery, and competitive prices to enhance their competitiveness.



# INVENTION PATENT

发明专利



# QUALITY CERTIFICATION

资质认证



## LDZY PHILOSOPHY

### 蓝雁哲学

#### 使命 Mission

为客户创造价值，为员工创造幸福；  
为行业塑造品牌，为社会作出贡献。

Create value for customers and create happiness for employees;  
Build a brand for the industry and contribute to the society.

#### 核心价值观 Core value

诚信、利他、感恩、和谐；  
敬天爱人，知行合一。

Integrity, altruism, gratitude, harmony;  
Respect heaven and love, unite knowledge and action.

#### 经营理念 Business philosophy

以客户需求为导向，持续创新！  
以奋斗者需求为本，高效协作！

Oriented by customer needs, continue to innovate!  
Based on the needs of strugglers, teamwork!

#### 愿景 Vision

成为一流的连接器 & 线束制造商。  
Become an excellent connector & harness manufacturer.

## INSPECTION EQUIPMENT 检查设备

为保证产品品质的优良和稳定，公司正不断引进一系列先进的生产设备和高精密的检测仪器，生产过程中严格管控产品品质。

In order to ensure the quality and stability of the products, the company is constantly introducing a series of advanced production equipment and high-precision testing instruments, and strictly control the quality of products during the production process.





## STAMPING WORKSHOP

冲压车间

蓝雁电子冲压部拥有雄厚的实力，能独立设计、制造各种高精度、高品质、高稳定性的五金连续模，先进的制造设备以及专业的技术人才、多年积累的管理经验，以充分保证产品的高品质。

LDZY Electronics the stamping department has strong strength and can independently design and manufacture all kinds of hardware continuous molds with high difficulty, high quality and high stability, advanced manufacturing equipment, professional technical talents and years of accumulated management experience to fully guarantee the high quality of the products quality.



## INJECTION WORKSHOP

注塑车间

蓝雁电子注重技术人才和管理团队培养，配备高精度进口模具加工设备，致力于提供更快更准更高效注塑成型服务，坚持以最好的品质，最快的交货期和最完善的售后服务回报新老客户。

LDZY Electronics focus on technical talents and management team training, equipped with high precision imported molding processing equipment, committed to providing faster, more accurate and more efficient injection molding services, adhere to the best quality, the fastest delivery time and the most perfect after sales service return New and old customers.







## FULLY AUTOMATIC ASSEMBLY WORKSHOP

全自动组装车间



# WIRE HARNESS PRODUCTION WORKSHOP

线束生产车间

经过不断积累发展，益隆电子集连接器线束研发生产一站式服务，更大程度降低时间、人力、物力成本。

After continuous accumulation and development, LDZY Electronics has developed a one-stop service for the development and production of connector harnesses, which has reduced time, manpower and material costs.







## WAREHOUSE 仓库

公司采用现代化大型三层储物仓，所有进项料件，必须有厂家检验合格证并由我司专业技术人员再次确认，确保入库的产品100%合格。

The company adopts modern large-scale three-storey storage bins. All the incoming materials must have the manufacturer's inspection certificate and be reconfirmed by our professional technicians to ensure that the products in the warehouse are 100% qualified.



# CONTENTS

## 目录

连接器&线束  
Connector & Cable Assembly



01 SERIES

CUSTOM CABLE ASSEMBLIES 01-02

02 SERIES

WIRE TO BOARD SERIES 03-47

03 SERIES

BOARD TO BOARD SERIES 48-52

04 SERIES

WIRE TO WIRE SERIES 53-64

05 SERIES

IDC / DIP CONNECTORS SERIES 65-70

06 SERIES

FPC / FFC CONNECTORS SERIES 71

07 SERIES

PIN HEADER / FEMALE HEADER SERIES 72-76

08 SERIES

OTHER SERIES 77





**A0600****0.60MM PITCH IDC SERIES****SPECIFICATIONS**

- ※ Current Rating: 0.2A AC/DC
- ※ Voltage Rating: 30V AC/DC
- ※ Temperature Range: -25°C~+85°C
- ※ Contact Resistance: 30mΩ Max.
- ※ Insulation Resistance: 100MΩ Min.
- ※ Withstanding Voltage: 200V AC/minute
- ※ Wire Range: AWG#34-36

Item	Part No.	Material	Poles	QTY
Wafer	A0600W/S/WRS-NP	LCP UL94V-0	02-18	4,500PCS/Reel
Housing	A0600H-NP	LCP UL94V-0	02-18	1,000PCS/Bag

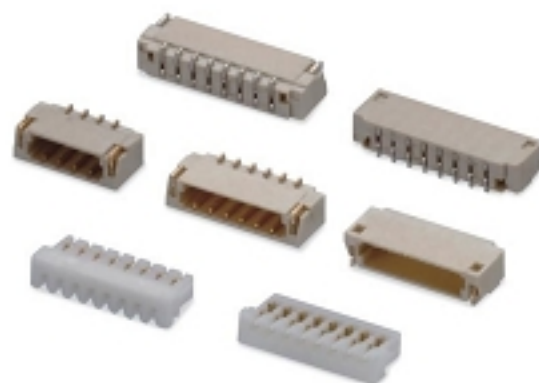
**A0800****0.80MM PITCH IDC SERIES****SPECIFICATIONS**

- ※ Current Rating: 0.5A AC/DC
- ※ Voltage Rating: 30V AC/DC
- ※ Temperature Range: -25°C~+85°C
- ※ Contact Resistance: 20mΩ Max.
- ※ Insulation Resistance: 100MΩ Min.
- ※ Withstanding Voltage: 200V AC/minute
- ※ Wire Range: AWG#32

Item	Part No.	Material	Poles	QTY
Wafer	A0800W/S/WRS-NP	LCP UL94V-0	02-20	3,500PCS/Reel
Housing	A0800H/H/E-NP	Nylon66 UL94V-0	02-20	1,000PCS/Bag

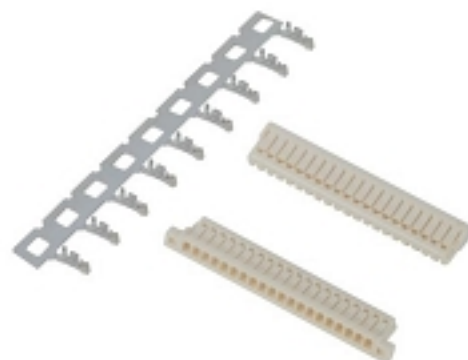
**A0801****0.80MM PITCH SERIES****SPECIFICATIONS**

- ※ Current Rating: 0.5A AC/DC
- ※ Voltage Rating: 30V AC/DC
- ※ Temperature Range: -25°C~+85°C
- ※ Contact Resistance: 20mΩ Max.
- ※ Insulation Resistance: 100MΩ Min.
- ※ Withstanding Voltage: 200V AC/minute
- ※ Wire Range: AWG#32-34

Item	Part No.	Material	Poles	QTY
Wafer	A0800W/S/WRS-NP	LCP UL94V-0	02-20	3,500PCS/Reel
Housing	A0801H/H/A-NP	Nylon46 UL94V-0	02-20	1,000PCS/Bag
Terminal	A0801TF-P	Phosphor Bronze		30,000PCS/Reel

**A1000****1.00MM PITCH IDC SERIES****SPECIFICATIONS**

- ※ Current Rating: 0.5A AC/DC
- ※ Voltage Rating: 30V AC/DC
- ※ Temperature Range: -25°C~+85°C
- ※ Contact Resistance: 20mΩ Max.
- ※ Insulation Resistance: 100MΩ Min.
- ※ Withstanding Voltage: 200V AC/minute
- ※ Wire Range: AWG#32

Item	Part No.	Material	Poles	QTY
Wafer	A1000W/S/WRS-NP	LCP UL94V-0	02-20	2,000PCS/Reel
Housing	A1000H-NP	LCP UL94V-0	02-20	1,000PCS/Bag

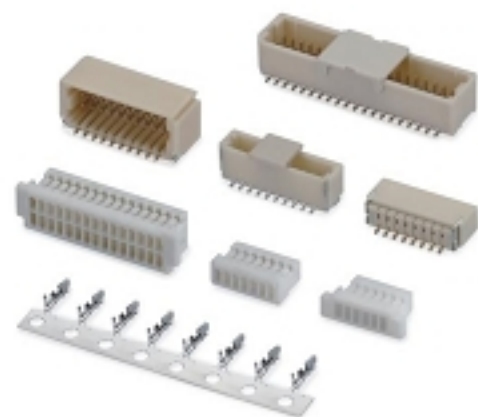
**A1001****1.00MM PITCH SERIES****SPECIFICATIONS**

- ※ Current Rating: 1A AC/DC
- ※ Voltage Rating: 50V AC/DC
- ※ Temperature Range: -25°C~+85°C
- ※ Contact Resistance: 20mΩ Max.
- ※ Insulation Resistance: 100MΩ Min.
- ※ Withstanding Voltage: 500V AC/minute
- ※ Wire Range: AWG#28~32

Item	Part No.	Material	Poles	QTY
Wafer	A1001WRS/WVS (Z/NP)	Nylon6T/9T UL94V-0	02-60	1,000PCS/Reel
Housing	A1001H (Z/NP)	PBT UL94V-0	02-60	1,000PCS/Bag
Terminal	A1001TF-P	Phosphor Bronze		20,000PCS/Reel

**A1002****1.00MM PITCH SERIES****SPECIFICATIONS**

- ※ Current Rating: 1A AC/DC
- ※ Voltage Rating: 125V AC/DC
- ※ Temperature Range: -25°C~+85°C
- ※ Contact Resistance: 20mΩ Max.
- ※ Insulation Resistance: 100MΩ Min.
- ※ Withstanding Voltage: 500V AC/minute
- ※ Wire Range: AWG#28~32

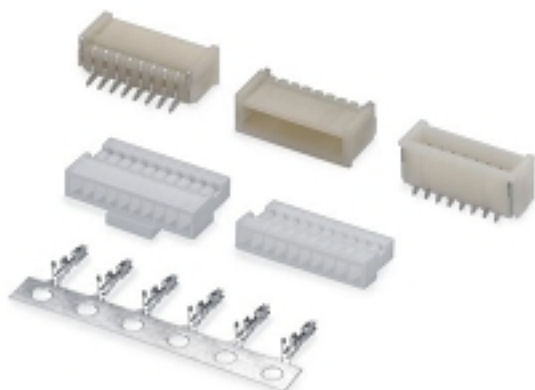

Item	Part No.	Material	Poles	QTY
Wafer	A1002WRS NP	Nylon6T, UL94V-0	02-20	1,000PCS/Reel
Housing	A1002H NP	Nylon66 UL94V-0	02-20	1,000PCS/Bag
Terminal	A1002TF-P	Phosphor Bronze		20,000PCS/Reel

**A1003****1.00MM PITCH SERIES****SPECIFICATIONS**

- ※ Current Rating: 1A AC/DC
- ※ Voltage Rating: 50V AC/DC
- ※ Temperature Range: -25°C~+85°C
- ※ Contact Resistance: 20mΩ Max.
- ※ Insulation Resistance: 100MΩ Min.
- ※ Withstanding Voltage: 500V AC/minute
- ※ Wire Range: AWG#28~32

Item	Part No.	Material	Poles	QTY
Wafer	A1003WRS NP	Nylon6T UL94V-0	02-30	1,000PCS/Reel
Housing	A1003H NP	Nylon66 UL94V-0	02-30	1,000PCS/Bag
Terminal	A1003TF-P	Phosphor Bronze		15,000PCS/Reel

**A1004****1.00MM PITCH SERIES****SPECIFICATIONS**

- ※ Current Rating: 1A AC/DC
- ※ Voltage Rating: 50V AC/DC
- ※ Temperature Range: -25°C~+85°C
- ※ Contact Resistance: 30mΩ Max.
- ※ Insulation Resistance: 100MΩ Min.
- ※ Withstanding Voltage: 500V AC/minute
- ※ Wire Range: AWG#28~32

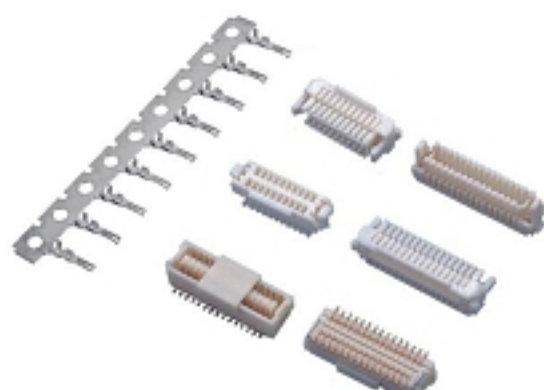

Item	Part No.	Material	Poles	QTY
Wafer	A1004WRS/WVS 2NP	Nylon6T UL94V-0	20/30/40/50	1,000PCS/Reel
Housing	A1004H 2NP	Nylon66 UL94V-0	20/30/40/50	1,000PCS/Bag
Terminal	A1004TF-P	Phosphor Bronze		20,000PCS/Reel



**A1005****1.00MM PITCH SERIES****SPECIFICATIONS**

- ※ Current Rating: 1A AC/DC
- ※ Voltage Rating: 125V AC/DC
- ※ Temperature Range: -25°C~+85°C
- ※ Contact Resistance: 20mΩ Max.
- ※ Insulation Resistance: 100MΩ Min.
- ※ Withstanding Voltage: 500V AC/minute
- ※ Wire Range: AWG#28~32

Item	A1005TF-P	Material	Poles	QTY
Wafer	A1005WFS/WVS-NP	Nylon6T UL94V-0	02~20	1,000PCS/Reel
Housing	A1005H-NP	Nylon66 UL94V-0	02~20	1,000PCS/Bag
Terminal	A1005TF-P	Phosphor Bronze		20,000PCS/Reel

**A1006****1.00MM PITCH SERIES****SPECIFICATIONS**

- ※ Current Rating: 1A AC/DC
- ※ Voltage Rating: 200V AC/DC
- ※ Temperature Range: -25°C~+85°C
- ※ Contact Resistance: 40mΩ Max.
- ※ Insulation Resistance: 100MΩ Min.
- ※ Withstanding Voltage: 500V AC/minute
- ※ Wire Range: AWG#28~32

Item	Part No.	Material	Poles	QTY
Wafer	A1006WRS NP	LCP/UL94V-0	20、30	2,000PCS/Reel
Housing	A1006H-NP	Nylon66 UL94V-0	20、30	1,000PCS/Bag
Terminal	A1006TF-P	Phosphor Bronze		20,000PCS/Reel

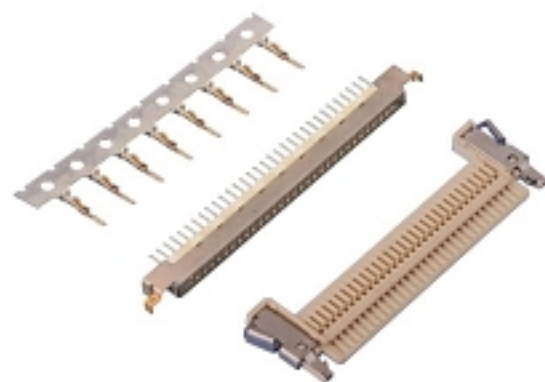
**A1008****1.00MM PITCH SERIES****SPECIFICATIONS**

- ※ Current Rating: 1A AC/DC
- ※ Voltage Rating: 200V AC/DC
- ※ Temperature Range: -25°C~+85°C
- ※ Contact Resistance: 40mΩ Max.
- ※ Insulation Resistance: 100MΩ Min.
- ※ Withstanding Voltage: 500V AC/minute
- ※ Wire Range: AWG#28~32

Item	Part No.	Material	Poles	QTY
Wafer	A1008WRS-NP	Nylon6T UL94V-0	30	2,000PCS/Reel
Housing	A1008H-NP	Nylon66 UL94V-0	30	1,000PCS/Bag
Terminal	A1008TF-P	Phosphor Bronze		20,000PCS/Reel

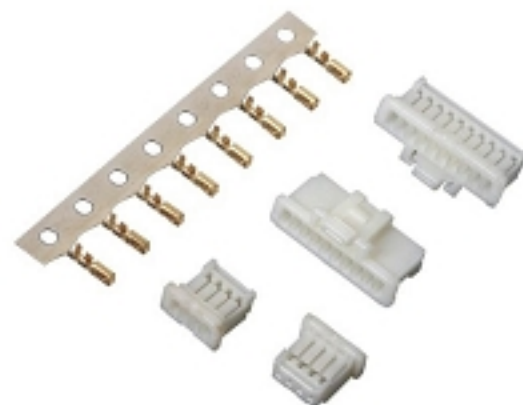
**A1009****1.00MM PITCH SERIES****SPECIFICATIONS**

- ※ Current Rating: 1A AC/DC
- ※ Voltage Rating: 50V AC/DC
- ※ Temperature Range: -25°C~+85°C
- ※ Contact Resistance: 20mΩ Max.
- ※ Insulation Resistance: 100MΩ Min.
- ※ Withstanding Voltage: 500V AC/minute
- ※ Wire Range: AWG#28~32

Item	Part No.	Material	Poles	QTY
Wafer	A1009WRS NP	Nylon6T UL94V-0	02~15	1,000PCS/Reel
Housing	A1009H-NP	Nylon66 UL94V-0	02~15	1,000PCS/Bag
Terminal	A1009TF-P	Phosphor Bronze		20,000PCS/Reel

**A1012****1.00MM PITCH SERIES****SPECIFICATIONS**

- ※ Current Rating: 1A AC/DC
- ※ Voltage Rating: 200V AC/DC
- ※ Temperature Range: -25°C~+85°C
- ※ Contact Resistance: 40mΩ Max.
- ※ Insulation Resistance: 100MΩ Min.
- ※ Withstanding Voltage: 500V AC/minute
- ※ Wire Range: AWG#28~32

Item	Part No.	Material	Poles	QTY
Wafer	A1006WRS-NP	LCP,UL94V-0	20, 30	2,000PCS/Reel
Housing	A1012VHA-NP	Nylon46 UL94V-0	20, 30	1,000PCS/Bag
Terminal	A1006TF-P	Phosphor Bronze		20,000PCS/Reel

**A1013****1.00MM PITCH SERIES****SPECIFICATIONS**

- ※ Current Rating: 1A AC/DC
- ※ Voltage Rating: 50V AC/DC
- ※ Temperature Range: -25°C~+85°C
- ※ Contact Resistance: 20mΩ Max.
- ※ Insulation Resistance: 100MΩ Min.
- ※ Withstanding Voltage: 500V AC/minute
- ※ Wire Range: AWG#28~32

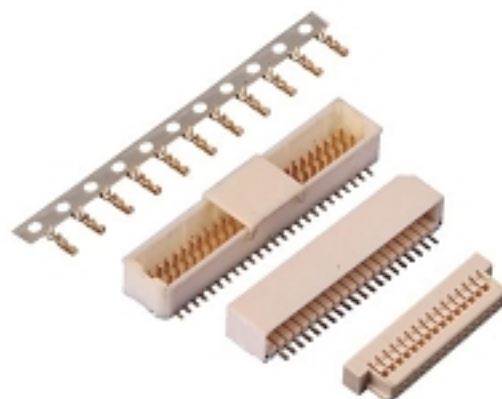

Item	Part No.	Material	Poles	QTY
Wafer	A1013WRS-2NP	Nylon6T UL94V-0	06-50	1,000PCS/Reel
Housing	A1013H-2NP	Nylon66 UL94V-0	06-50	1,000PCS/Bag
Terminal	A1013TF-P	Phosphor Bronze		15,000PCS/Reel

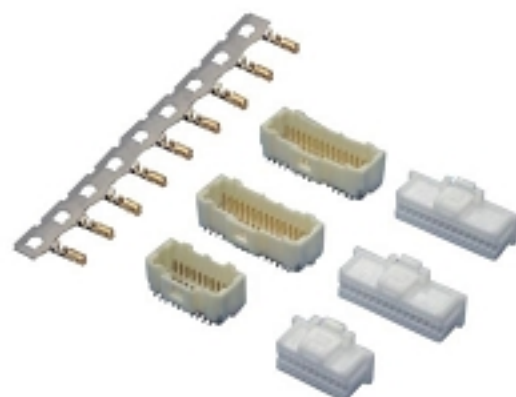
**A1014****1.00MM PITCH SERIES****SPECIFICATIONS**

- ※ Current Rating: 1A AC/DC
- ※ Voltage Rating: 50V AC/DC
- ※ Temperature Range: -25°C~+85°C
- ※ Contact Resistance: 20mΩ Max.
- ※ Insulation Resistance: 100MΩ Min.
- ※ Withstanding Voltage: 250V AC/minute
- ※ Wire Range: AWG#28~32

Item	Part No.	Material	Poles	QTY
Wafer	A1014WRS/WRS-2NP	Nylon6T UL94V-0	20-60	1,000PCS/Reel
Housing	A1014H-2NP	Nylon66 UL94V-0	20-60	1,000PCS/Bag
Terminal	A1014TF-P	Phosphor Bronze		15,000PCS/Reel

**A1015****1.00MM PITCH SERIES****SPECIFICATIONS**

- ※ Current Rating: 1A AC/DC
- ※ Voltage Rating: 200V AC/DC
- ※ Temperature Range: -25°C~+85°C
- ※ Contact Resistance: 20mΩ Max.
- ※ Insulation Resistance: 100MΩ Min.
- ※ Withstanding Voltage: 500V AC/minute
- ※ Wire Range: AWG#28~32



Item	Part No.	Material	Poles	QTY
Wafer	A1006WRS-NP	LCP,UL94V-0	20, 30	2,000PCS/Reel
Housing	A1015H-NP	Nylon46 UL94V-0	20, 30	1,000PCS/Bag
Terminal	A1006TF-P	Phosphor Bronze		20,000PCS/Reel



**A1201****1.20MM PITCH SERIES****SPECIFICATIONS**

- ※ Current Rating: 1.5A AC/DC
- ※ Voltage Rating: 50V AC/DC
- ※ Temperature Range: -25°C~+85°C
- ※ Contact Resistance: 20mΩ Max.
- ※ Insulation Resistance: 100MΩ Min.
- ※ Withstanding Voltage: 500V AC/minute
- ※ Wire Range: AWG#30~36

Item	Part No.	Material	Poles	QTY
Wafer	A1201WRS-NP	LCP,UL94V-0	02-07	4,000PCS/Reel
Housing	A1201H-NP	Nylon10T,UL94V-0	02-07	1,000PCS/Bag
Terminal	A1201TF-P	Phosphor Bronze		15,000PCS/Reel

**A1203****1.20MM PITCH SERIES****SPECIFICATIONS**

- ※ Current Rating: 2A AC/DC
- ※ Voltage Rating: 50V AC/DC
- ※ Temperature Range: -25°C~+85°C
- ※ Contact Resistance: 10mΩ Max.
- ※ Insulation Resistance: 100MΩ Min.
- ※ Withstanding Voltage: 500V AC/minute
- ※ Wire Range: AWG#28~32

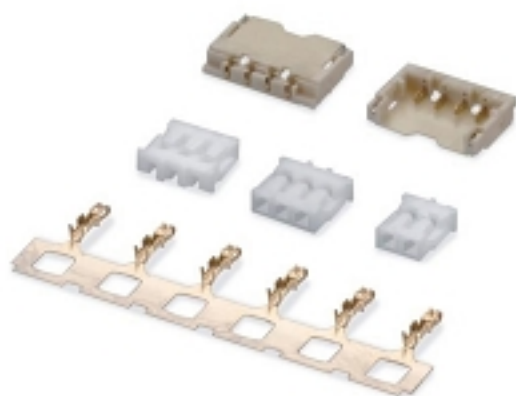

Item	Part No.	Material	Poles	QTY
Wafer	A1203WRS-NP	Nylon6T/LCP,UL94V-0	02-15	4,500PCS/Reel
Housing	A1203HVA-NP	Nylon66,UL94V-0	02-15	1,000PCS/Bag
Terminal	A1203TF-P	Phosphor Bronze		15,000PCS/Reel

**A1204****1.20MM PITCH SERIES****SPECIFICATIONS**

- ※ Current Rating: 2A AC/DC
- ※ Voltage Rating: 50V AC/DC
- ※ Temperature Range: -25°C~+85°C
- ※ Contact Resistance: 20mΩ Max.
- ※ Insulation Resistance: 100MΩ Min.
- ※ Withstanding Voltage: 500V AC/minute
- ※ Wire Range: AWG#28~32

Item	Part No.	Material	Poles	QTY
Wafer	A1204WRS-NP	LCP,UL94V-0	02-06	4,500PCS/Reel
Housing	A1204HVA-NP	PBT,UL94V-0	02-06	1,000PCS/Bag
Terminal	A1204TF-P	Phosphor Bronze		20,000PCS/Reel

**A1205****1.20MM PITCH SERIES****SPECIFICATIONS**

- ※ Current Rating: 2A AC/DC
- ※ Voltage Rating: 30V AC/DC
- ※ Temperature Range: -25°C~+85°C
- ※ Contact Resistance: 20mΩ Max.
- ※ Insulation Resistance: 100MΩ Min.
- ※ Withstanding Voltage: 500V AC/minute
- ※ Wire Range: AWG#28~30

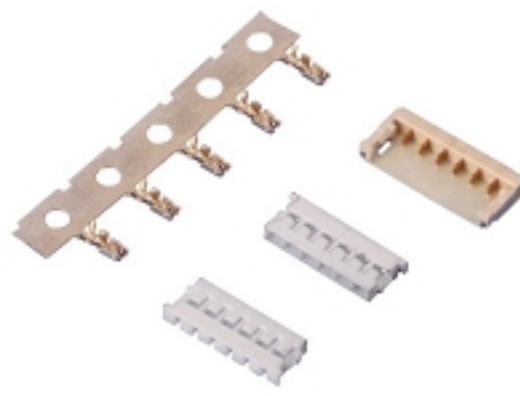

Item	Part No.	Material	Poles	QTY
Wafer	A1205WRS-NP	LCP,UL94V-0	02-09	1,000PCS/Reel
Housing	A1205H-NP	Nylon66,UL94V-0	02-09	1,000PCS/Bag
Terminal	A1205TF-P	Phosphor Bronze		15,000PCS/Reel

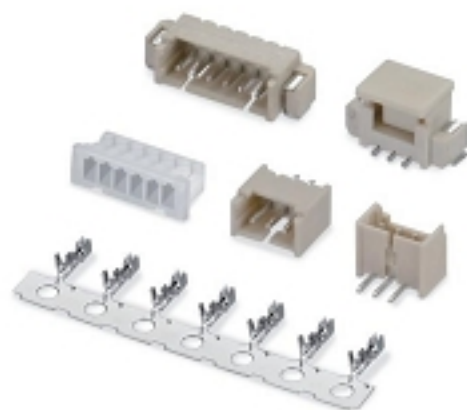
**A1250****1.25MM PITCH SERIES****SPECIFICATIONS**

- ※ Current Rating: 1A AC/DC
- ※ Voltage Rating: 125V AC/DC
- ※ Temperature Range: -25°C~+85°C
- ※ Contact Resistance: 20mΩ Max.
- ※ Insulation Resistance: 100MΩ Min.
- ※ Withstanding Voltage: 500V AC/minute
- ※ Wire Range: AWG#28~32

Item	Part No.	Material	Poles	QTY
Wafer	A1250WV/WR(A)IS-NP	Nylon6T/9T UL94V0	02~18	1,000PCS/Reel
Housing	A1250H/HM-NP	Nylon66 UL94V0	02~18	1,000PCS/Bag
Terminal	A1250TF/TM-P	Phosphor Bronze		20,000PCS/Reel

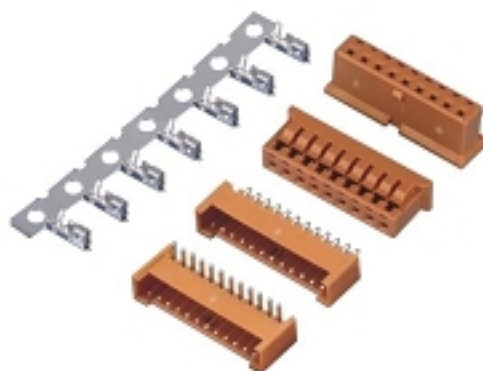
**A1251****1.25MM PITCH SERIES****SPECIFICATIONS**

- ※ Current Rating: 1A AC/DC
- ※ Voltage Rating: 200V AC/DC
- ※ Temperature Range: -25°C~+85°C
- ※ Contact Resistance: 20mΩ Max.
- ※ Insulation Resistance: 100MΩ Min.
- ※ Withstanding Voltage: 500V AC/minute
- ※ Wire Range: AWG#28~32

Item	Part No.	Material	Poles	QTY
Wafer	A1251WV/WR NP	Nylon66 UL94V0	02~15	1,000PCS/Bag
Housing	A1251H-NP	Nylon66 UL94V0	02~15	1,000PCS/Bag
Terminal	A1251TF-P	Phosphor Bronze		10,000PCS/Reel

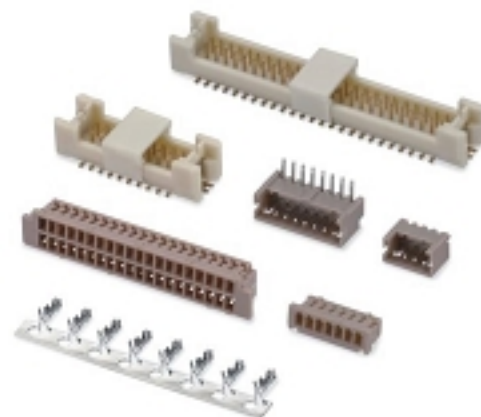
**A1252****1.25MM PITCH SERIES****SPECIFICATIONS**

- ※ Current Rating: 1A AC/DC
- ※ Voltage Rating: 150V AC/DC
- ※ Temperature Range: -25°C~+85°C
- ※ Contact Resistance: 30mΩ Max.
- ※ Insulation Resistance: 500MΩ Min.
- ※ Withstanding Voltage: 500V AC/minute
- ※ Wire Range: AWG#26~30

Item	Part No.	Material	Poles	QTY
Wafer	A1252WV/WR(A)IS-I2/NP	Nylon6T/9T UL94V0	02-15/26-30/25	1,000PCS/Reel
Housing	A1252H/A-I2/NP	Nylon66 UL94V0	02-15/26-30/25	1,000PCS/Bag
Terminal	A1252TF-P	Phosphor Bronze		20,000PCS/Reel

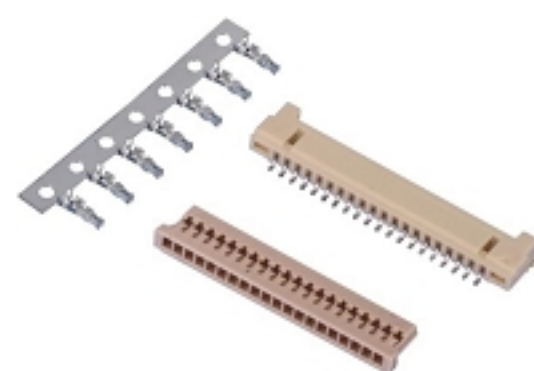
**A1253****1.25MM PITCH SERIES****SPECIFICATIONS**

- ※ Current Rating: 1A AC/DC
- ※ Voltage Rating: 150V AC/DC
- ※ Temperature Range: -25°C~+85°C
- ※ Contact Resistance: 30mΩ Max.
- ※ Insulation Resistance: 500MΩ Min.
- ※ Withstanding Voltage: 500V AC/minute
- ※ Wire Range: AWG#26~32

Item	Part No.	Material	Poles	QTY
Wafer	A1253WRS NP	LCP/Nylon6T UL94V0	02~30	1,000PCS/Reel
Housing	A1253H-NP	Nylon66 UL94V0	02~30	1,000PCS/Bag
Terminal	A1253TF-P	Phosphor Bronze		20,000PCS/Reel



**A1253A**

## 1.25MM PITCH SERIES

**SPECIFICATIONS**

- ※ Current Rating: 1A AC/DC
- ※ Voltage Rating: 150V AC/DC
- ※ Temperature Range: -25°C~+85°C
- ※ Contact Resistance: 30mΩ Max.
- ※ Insulation Resistance: 500MΩ Min.
- ※ Withstanding Voltage: 500V AC/minute
- ※ Wire Range: AWG#26~32

Item	Part No.	Material	Poles	QTY
Wafer	A1253WA/A/S-NP	Nylon6T UL94V-0	02-30	1,000PCS/Reel
Housing	A1253HA-NP	Nylon66 UL94V-0	02-30	1,000PCS/Bag
Terminal	A1253TF-P	Phosphor Bronze		15,000PCS/Reel

**A1254**

## 1.25MM PITCH SERIES

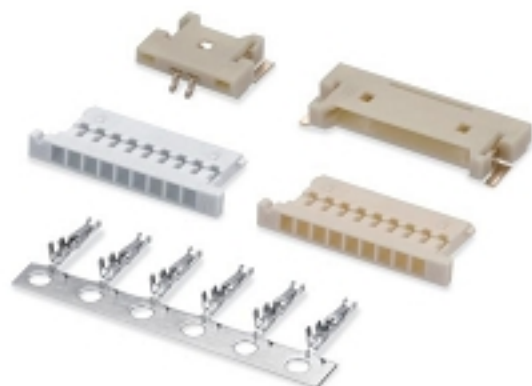
**SPECIFICATIONS**

- ※ Current Rating: 1A AC/DC
- ※ Voltage Rating: 125V AC/DC
- ※ Temperature Range: -25°C~+85°C
- ※ Contact Resistance: 20mΩ Max.
- ※ Insulation Resistance: 100MΩ Min.
- ※ Withstanding Voltage: 500V AC/minute
- ※ Wire Range: AWG#28~32

Item	Part No.	Material	Poles	QTY
Wafer	A1254WA/A/B/C/S-NP	Nylon6T UL94V-0	02-30	1,000PCS/Reel
Housing	A1254HA-NP	Nylon66 UL94V-0	02-30	1,000PCS/Bag
Terminal	A1254TF-P	Phosphor Bronze		15,000PCS/Reel

**A1255**

## 1.25MM PITCH SERIES

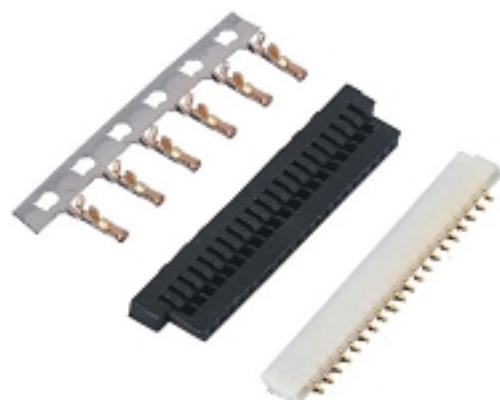
**SPECIFICATIONS**

- ※ Current Rating: 1A AC/DC
- ※ Voltage Rating: 200V AC/DC
- ※ Temperature Range: -25°C~+85°C
- ※ Contact Resistance: 40mΩ Max.
- ※ Insulation Resistance: 100MΩ Min.
- ※ Withstanding Voltage: 500V AC/minute
- ※ Wire Range: AWG#28~32

Item	Part No.	Material	Poles	QTY
Wafer	A1255WA/A/S-NP	LCP/Nylon6T UL94V-0	02-30	1,000PCS/Reel
Housing	A1255HA-NP	Nylon66 UL94V-0	02-30	1,000PCS/Bag
Terminal	A1255TF-P	Phosphor Bronze		15,000PCS/Reel

**A1256**

## 1.25MM PITCH SERIES

**SPECIFICATIONS**

- ※ Current Rating: 1A AC/DC
- ※ Voltage Rating: 200V AC/DC
- ※ Temperature Range: -25°C~+85°C
- ※ Contact Resistance: 40mΩ Max.
- ※ Insulation Resistance: 100MΩ Min.
- ※ Withstanding Voltage: 500V AC/minute
- ※ Wire Range: AWG#28~32

Item	Part No.	Material	Poles	QTY
Wafer	A1256WA/A/S/2NP	Nylon6T UL94V-0	06-41	1,000PCS/Reel
Housing	A1256HA/A/2NP	Nylon66 UL94V-0	06-41	1,000PCS/Bag
Terminal	A1256TF-P	Phosphor Bronze		15,000PCS/Reel

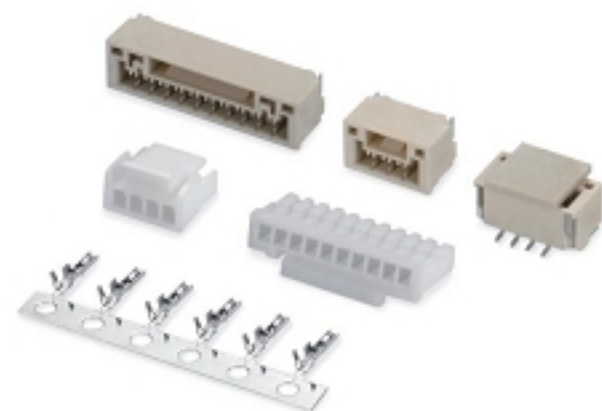
**A1257****1.25MM PITCH SERIES****SPECIFICATIONS**

- ※ Current Rating: 1A AC/DC
- ※ Voltage Rating: 50V AC/DC
- ※ Temperature Range: -25°C~+85°C
- ※ Contact Resistance: 30mΩ Max.
- ※ Insulation Resistance: 100MΩ Min.
- ※ Withstanding Voltage: 500V AC/minute
- ※ Wire Range: AWG#26~32

Item	Part No.	Material	Poles	QTY
Wafer	A1257W/S/WRS-NP	Nylon6T UL94V-0	02~15	1,000PCS/Reel
Housing	A1257H-NP	Nylon66 UL94V-0	02~15	1,000PCS/Bag
Terminal	A1257TF-P	Phosphor Bronze		15,000PCS/Reel

**A1258****1.50MM PICH SERIES****SPECIFICATIONS**

- ※ Current Rating: 1A AC/DC
- ※ Voltage Rating: 50V AC/DC
- ※ Temperature Range: -25°C~+85°C
- ※ Contact Resistance: 50mΩ Max.
- ※ Insulation Resistance: 1000MΩ Min.
- ※ Withstanding Voltage: 500V AC/minute
- ※ Wire Range: AWG#26-32

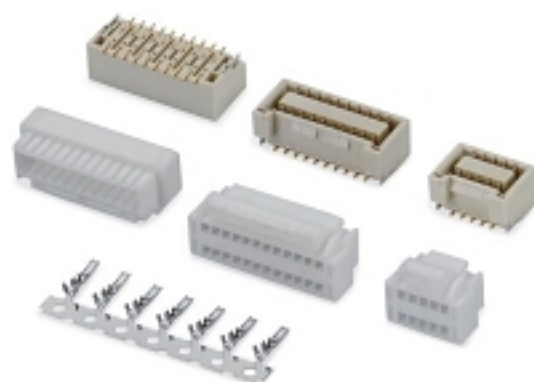

Item	Part No.	Material	Poles	QTY
Wafer	A1258W/S-2NP	LCP UL94V-0	10~40	1,000PCS/Reel
Housing	A1258H-2NP	Nylon66 UL94V-0	10~40	1,000PCS/Bag
Terminal	A1258TF-P	Phosphor Bronze		20,000PCS/Reel

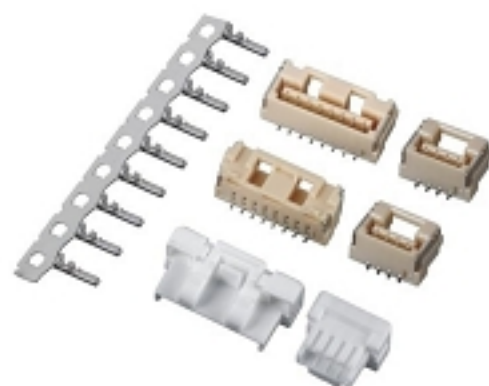
**A1259****1.25MM PITCH SERIES****SPECIFICATIONS**

- ※ Current Rating: 1A AC/DC
- ※ Voltage Rating: 50V AC/DC
- ※ Temperature Range: -25°C~+85°C
- ※ Contact Resistance: 20mΩ Max.
- ※ Insulation Resistance: 100MΩ Min.
- ※ Withstanding Voltage: 500V AC/minute
- ※ Wire Range: AWG#26~28

Item	Part No.	Material	Poles	QTY
Wafer	A1259W/S/WRS-NP	LCP UL94V-0	02~15	1,000PCS/Reel
Housing	A1259H-NP	Nylon66 UL94V-0	02~15	1,000PCS/Bag
Terminal	A1259TF-P	Phosphor Bronze		15,000PCS/Reel

**A1300****1.30MM PITCH SERIES****SPECIFICATIONS**

- ※ Current Rating: 2A AC/DC
- ※ Voltage Rating: 30V AC/DC
- ※ Temperature Range: -25°C~+85°C
- ※ Contact Resistance: 20mΩ Max.
- ※ Insulation Resistance: 100MΩ Min.
- ※ Withstanding Voltage: 500V AC/minute
- ※ Wire Range: AWG#26~28

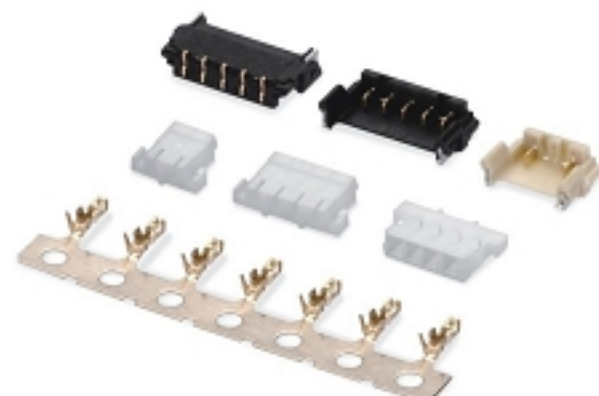

Item	Part No.	Material	Poles	QTY
Wafer	A1300W/S NP	Nylon4T,UL94V-0	02~12	1000PCS/Reel
Housing	A1300H NP-NONAO	Nylon66 UL94V-0	02~12	1000PCS/Bag
Terminal	A1300TF-PG1	Phosphor Bronze		15,000PCS/Reel



**A1500**

## 1.50MM PITCH SERIES

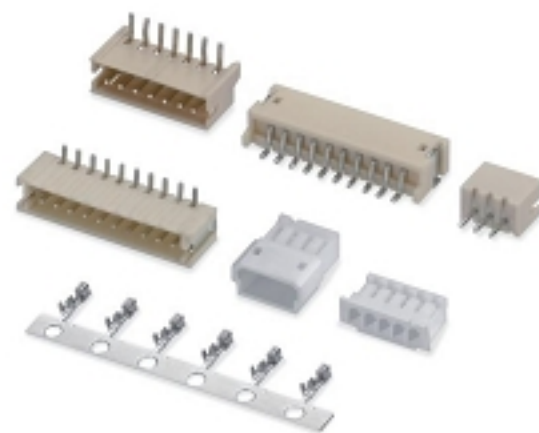
**SPECIFICATIONS**

- ※ Current Rating: 1A AC/DC
- ※ Voltage Rating: 100V AC/DC
- ※ Temperature Range: -25°C~+85°C
- ※ Contact Resistance: 20mΩ Max.
- ※ Insulation Resistance: 500MΩ Min.
- ※ Withstanding Voltage: 500V AC/minute
- ※ Wire Range: AWG#26~32

Item	Part No.	Material	Poles	QTY
Wafer	A1500W/R/WV/RIS-NP	Nylon66/Nylon6T UL94V-0	02~15	1,000PCS/Reel
Housing	A1500H+NP	Nylon66 UL94V-0	02~15	1,000PCS/Bag
Terminal	A1500TF-P	Phosphor Bronze		18,000PCS/Reel

**A1501**

## 1.50MM PITCH SERIES

**SPECIFICATIONS**

- ※ Current Rating: 3A AC/DC
- ※ Voltage Rating: 350V AC/DC
- ※ Temperature Range: -25°C~+85°C
- ※ Contact Resistance: 20mΩ Max.
- ※ Insulation Resistance: 1000MΩ Min.
- ※ Withstanding Voltage: 500V AC/minute
- ※ Wire Range: AWG#24~28

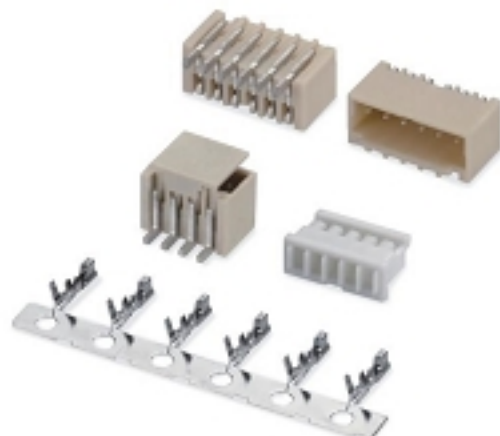

Item	Part No.	Material	Poles	QTY
Wafer	A1501W/S/WRS-NP	LCP UL94V-0	02~15	1,000PCS/Reel
Housing	A1501H+NP	Nylon66 UL94V-0	02~15	1,000PCS/Bag
Terminal	A1501TF-P	Phosphor Bronze		15,000PCS/Reel

**A1502**

## 1.50MM PITCH SERIES

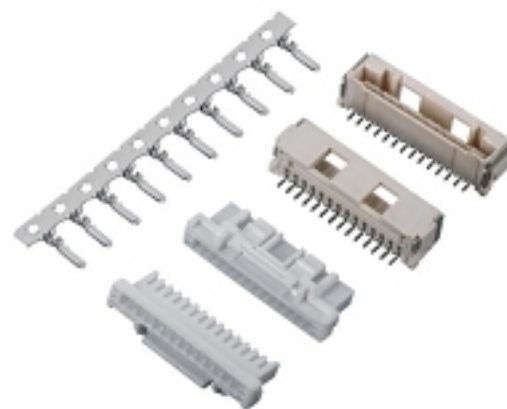
**SPECIFICATIONS**

- ※ Current Rating: 2A AC/DC
- ※ Voltage Rating: 100V AC/DC
- ※ Temperature Range: -25°C~+85°C
- ※ Contact Resistance: 20mΩ Max.
- ※ Insulation Resistance: 500MΩ Min.
- ※ Withstanding Voltage: 500V AC/minute
- ※ Wire Range: AWG#24~28

Item	Part No.	Material	Poles	QTY
Wafer	A1502W/R/RIS-NP	LCP UL94V-0	02~15	1,000PCS/Reel
Housing	A1502H+NP	Nylon66 UL94V-0	02~15	1,000PCS/Bag
Terminal	A1502TF-P	Phosphor Bronze		15,000PCS/Reel

**A1503**

## 1.50MM PITCH SERIES

**SPECIFICATIONS**

- ※ Current Rating: 3A AC/DC
- ※ Voltage Rating: 150V AC/DC
- ※ Temperature Range: -25°C~+85°C
- ※ Contact Resistance: 20mΩ Max.
- ※ Insulation Resistance: 1000MΩ Min.
- ※ Withstanding Voltage: 500V AC/minute
- ※ Wire Range: AWG#28~30

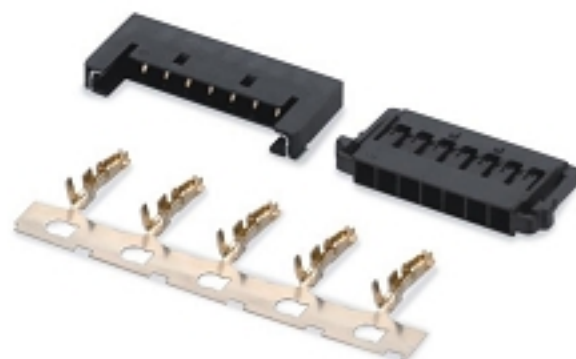

Item	Part No.	Material	Poles	QTY
Wafer	A1503WRS-NP	LCP UL94V-0	04~12	2,000PCS/Reel
Housing	A1503H+NP	Nylon66 UL94V-0	04~12	1,000PCS/Bag
Terminal	A1503TF-P	Phosphor Bronze		20,000PCS/Reel

**A1505**

## 1.50MM PICH SERIES

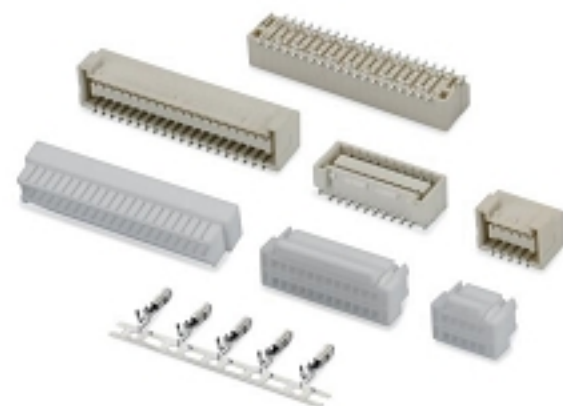
**SPECIFICATIONS**

- ※ Current Rating: 2A AC/DC (10P-30P) ; 1.5A AC/DC(32P-40P)
- ※ Voltage Rating: 100V AC/DC
- ※ Temperature Range: -25°C~+85°C
- ※ Contact Resistance: 30mΩ Max.
- ※ Insulation Resistance: 500MΩ Min.
- ※ Withstanding Voltage: 500V AC/minute
- ※ Wire Range: AWG#24~28

Item	Part No.	Material	Poles	QTY
Wafer	A1506WRS/WVS-2NP	LCP UL94V-0	10-40	7,000PCS/Bag
Housing	A1506H-2NP	Nylon66 UL94V-0	10-40	1,000PCS/Bag
Terminal	A1505TF-P	Phosphor Bronze		15,000PCS/Reel

**A1506**

## 1.50MM PICH SERIES

**SPECIFICATIONS**

- ※ Current Rating: 2A AC/DC
- ※ Voltage Rating: 125V AC/DC
- ※ Temperature Range: 40°C~+105°C
- ※ Contact Resistance: 20mΩ Max.
- ※ Insulation Resistance: 500MΩ Min.
- ※ Withstanding Voltage: 800V AC/minute
- ※ After environmental testing: 40mΩ Max.
- ※ Wire Range: AWG#24~28

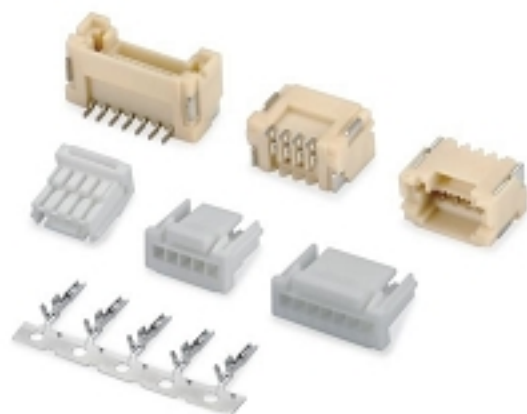

Item	Part No.	Material	Poles	QTY
Wafer	A1506WRS/WVS-NP	PA9T UL94V-0	02-18	1,000PCS/Reel
Housing	A1506H-NP	PBT UL94V-0	02-18	1,000PCS/Bag
Terminal	A1506TF-P	Phosphor Bronze		10,000/Reel

**A1511**

## 1.50MM PICH SERIES

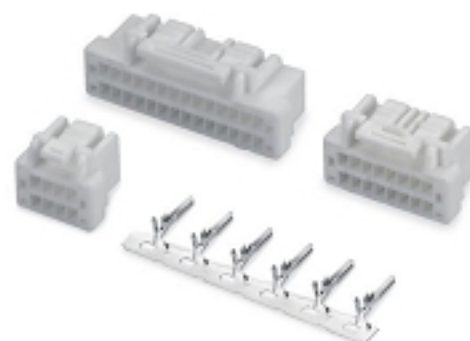
**SPECIFICATIONS**

- ※ Current Rating: 4A AC/DC
- ※ Voltage Rating: 350V AC/DC
- ※ Temperature Range: -40°C~+105°C
- ※ Contact Resistance: 20mΩ Max.
- ※ Insulation Resistance: 1000MΩ Min.
- ※ Withstanding Voltage: 500V AC/minute
- ※ After environmental testing: 40mΩ Max.
- ※ Wire Range: AWG#24~28

Item	Part No.	Material	Poles	QTY
Wafer	A1511WRS/WVS-2NP	LCP UL94V-0	20	900PCS/Reel
Housing	A1511H-2NP	PBT UL94V-0	20	1,000PCS/Bag
Terminal	A1511TF-P	Phosphor Bronze		10,000PCS/Reel

**A1800**

## 1.80MM PITCH SERIES

**SPECIFICATIONS**

- ※ Current Rating: 3.2A AC/DC
- ※ Voltage Rating: 350V AC/DC
- ※ Temperature Range: -25°C~+85°C
- ※ Contact Resistance: 20mΩ Max.
- ※ Insulation Resistance: 1000MΩ Min.
- ※ Withstanding Voltage: 1700V AC/minute
- ※ Wire Range: AWG#22~26



Item	Part No.	Material	Poles	QTY
Wafer	A1800WR/AUS-NP	LCP/Nylon9T UL94V-0	02	1,000PCS/Reel
Housing	A1800H/HV/HB-NP	Nylon66 UL94V-0	02	1,000PCS/Bag
Terminal	A1800TF-P	Phosphor Bronze		15,000PCS/Reel

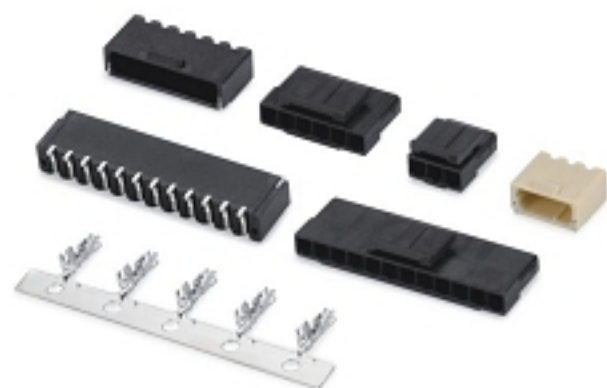

**A1801****1.80MM PICH SERIES****SPECIFICATIONS**

- ※ Current Rating: 4A AC/DC
- ※ Voltage Rating: 350V AC/DC
- ※ Temperature Range: -40°C~+105°C
- ※ Contact Resistance: 10mΩ Max.
- ※ Insulation Resistance: 1000MΩ Min.
- ※ Withstanding Voltage: 1700V AC/minute
- ※ After environmental testing: 20mΩ Max.
- ※ Wire Range: AWG#22-28

Item	Part No.	Material	Poles	QTY
Wafer	A1801WRIS-NP	PA4T UL94V0	03-12	1,000PCS/Bag
Housing	A1801HF-NP	Nylon66 UL94V0	03-12	1,000PCS/Bag
Terminal	A1804TF-P	Phosphor Bronze		8,000/Reel

**A2001****2.00MM PITCH SERIES****SPECIFICATIONS**

- ※ Current Rating: 2A AC/DC
- ※ Voltage Rating: 100V AC/DC
- ※ Temperature Range: -25°C~+85°C
- ※ Contact Resistance: 10mΩ Max.
- ※ Insulation Resistance: 1000MΩ Min.
- ※ Withstanding Voltage: 800V AC/minute
- ※ Wire Range: AWG#24~30

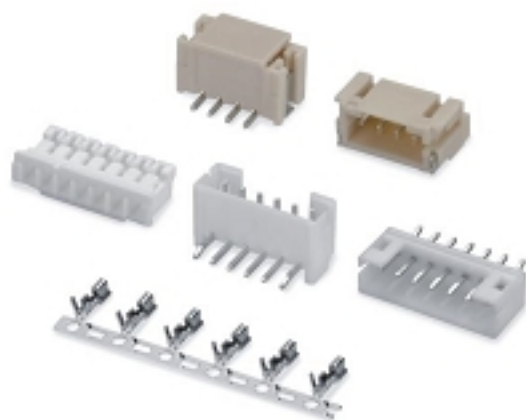

Item	Part No.	Material	Poles	QTY
Wafer	A2001WV/WRIS-NP	Nylon66/Nylon6T UL94V0	02-18	1,000PCS/Bag
Housing	A2001H-NP	Nylon66 UL94V0	02-18	1,000PCS/Bag
Terminal	A2001TF-P	Phosphor Bronze		11,000PCS/Reel

**A2002****2.00MM PITCH SERIES****SPECIFICATIONS**

- ※ Current Rating: 2A AC/DC
- ※ Voltage Rating: 125V AC/DC
- ※ Temperature Range: -25°C~+85°C
- ※ Contact Resistance: 20mΩ Max.
- ※ Insulation Resistance: 1000MΩ Min.
- ※ Withstanding Voltage: 800V AC/minute
- ※ Wire Range: AWG#24~30

Item	Part No.	Material	Poles	QTY
Wafer	A2002WV/WR-NP	Nylon66 UL94V0	02-15	1,000PCS/Bag
Housing	A2002H-NP	Nylon66 UL94V0	02-15	1,000PCS/Bag
Terminal	A2002TF-P	Phosphor Bronze		10,000PCS/Reel

**A2004****2.00MM PITCH SERIES****SPECIFICATIONS**

- ※ Current Rating: 3A AC/DC
- ※ Voltage Rating: 250V AC/DC
- ※ Temperature Range: -25°C~+85°C
- ※ Contact Resistance: 10mΩ Max.
- ※ Insulation Resistance: 1000MΩ Min.
- ※ Withstanding Voltage: 800V AC/minute
- ※ Wire Range: AWG#22~28

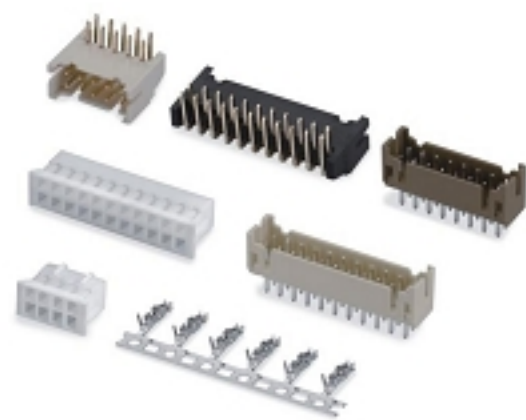

Item	Part No.	Material	Poles	QTY
Wafer	A2004WV/WR 2NP	Nylon66 UL94V0	04-40	1,000PCS/Bag
Housing	A2004H 2NP	Nylon66 UL94V0	04-40	1,000PCS/Bag
Terminal	A2004TF-P	Phosphor Bronze		10,000PCS/Reel



## A2004HA

### 2.00MM PITCH SERIES

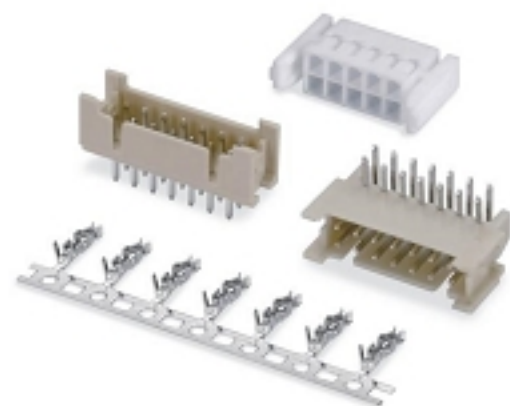

#### SPECIFICATIONS

- ※ Current Rating: 3A AC/DC
- ※ Voltage Rating: 250V AC/DC
- ※ Temperature Range: -25°C~+85°C
- ※ Contact Resistance: 10mΩ Max.
- ※ Insulation Resistance: 1000MΩ Min.
- ※ Withstanding Voltage: 800V AC/minute
- ※ Wire Range: AWG#22~28

Item	Part No.	Material	Poles	QTY
Wafer	A2004WRA/WVA-2NP	Nylon66/9T UL94V-0	04~40	1,000PCS/Bag
Housing	A2004HA-2NP	Nylon66 UL94V-0	04~40	1,000PCS/Bag
Terminal	A2004TF-P	Phosphor Bronze		10,000PCS/Reel

## A2004HB

### 2.00MM PITCH SERIES

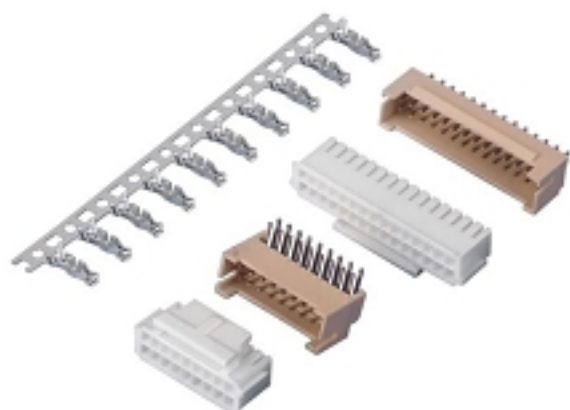

#### SPECIFICATIONS

- ※ Current Rating: 3A AC/DC
- ※ Voltage Rating: 250V AC/DC
- ※ Temperature Range: -25°C~+85°C
- ※ Contact Resistance: 10mΩ Max.
- ※ Insulation Resistance: 1000MΩ Min.
- ※ Withstanding Voltage: 800V AC/minute
- ※ Wire Range: AWG#22~28

Item	Part No.	Material	Poles	QTY
Wafer	A2004WVB/WVB-2NP	Nylon46/68 UL94V-0	04~40	1,000PCS/Bag
Housing	A2004HB-2NP	Nylon66 UL94V-0	04~40	1,000PCS/Bag
Terminal	A2004TFB-P	Phosphor Bronze		10,000PCS/Reel



## A2005

### 2.00MM PITCH SERIES



#### SPECIFICATIONS

- ※ Current Rating: 3A AC/DC
- ※ Voltage Rating: 250V AC/DC
- ※ Temperature Range: -25°C~+85°C
- ※ Contact Resistance: 30mΩ Max.
- ※ Insulation Resistance: 1000MΩ Min.
- ※ Withstanding Voltage: 650V AC/minute
- ※ Wire Range: AWG#22~28

Item	Part No.	Material	Poles	QTY
Wafer	A2005WV/WR-NP	Nylon66 UL94V-0	02~15	1,000PCS/Bag
Housing	A2005H-NP	Nylon66 UL94V-0	02~15	1,000PCS/Bag
Terminal	A2005TF-P	Phosphor Bronze		10,000PCS/Reel

## A2006

### 2.00MM PITCH SERIES

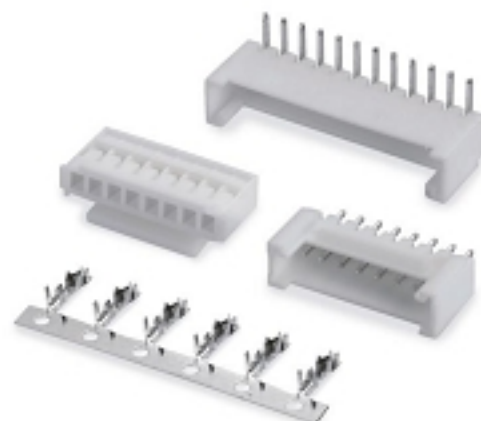

#### SPECIFICATIONS

- ※ Current Rating: 3A AC/DC
- ※ Voltage Rating: 250V AC/DC
- ※ Temperature Range: -25°C~+85°C
- ※ Contact Resistance: 30mΩ Max.
- ※ Insulation Resistance: 1000MΩ Min.
- ※ Withstanding Voltage: 1000V AC/minute
- ※ Wire Range: AWG#24~28

Item	Part No.	Material	Poles	QTY
Wafer	A2006WV/WR-NP	Nylon66 UL94V-0	02~18	1,000PCS/Bag
Housing	A2006H(M)-NP	Nylon66 UL94V-0	02~18	1,000PCS/Bag
Terminal	A2006TM/PIA2211TF-P	Phosphor Bronze		10,000PCS/Reel

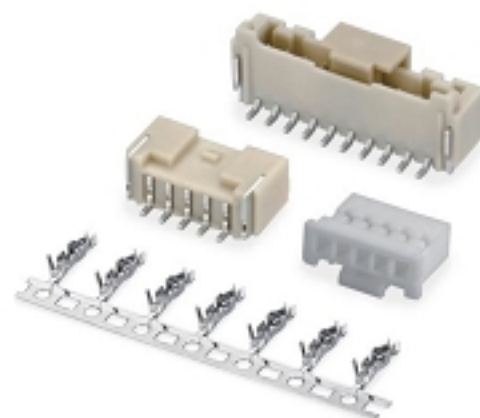

**A2007****2.00MM PITCH SERIES****SPECIFICATIONS**

- ※ Current Rating: 3A AC/DC
- ※ Voltage Rating: 250V AC/DC
- ※ Temperature Range: -25°C~+85°C
- ※ Contact Resistance: 20mΩ Max.
- ※ Insulation Resistance: 1000MΩ Min.
- ※ Withstanding Voltage: 800V AC/minute
- ※ Wire Range: AWG#22~28

Item	Part No.	Material	Poles	QTY
Wafer	A2007WV/WR(S)-NP	Nylon6T UL94V-0	02~16	1,000PCS/Reel
Housing	A2007H+NP	Nylon66 UL94V-0	02~16	1,000PCS/Bag
Terminal	A2004TF-P	Phosphor Bronze		10,000PCS/Reel

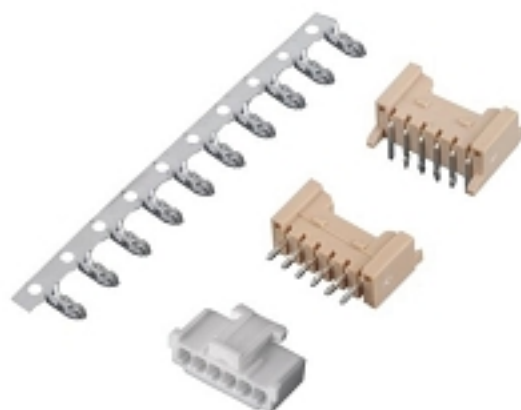
**A2008****2.00MM PITCH SERIES****SPECIFICATIONS**

- ※ Current Rating: 2A AC/DC
- ※ Voltage Rating: 125V AC/DC
- ※ Temperature Range: -40°C~+105°C
- ※ Contact Resistance: <math>\leq 20\text{m}\Omega</math> Max.
- ※ Insulation Resistance:  $\geq 1000\text{M}\Omega$  Min.
- ※ Withstanding Voltage: 800V AC/minute
- ※ Wire Range: AWG#24~30

Item	Part No.	Material	Poles	QTY
Wafer	A2008WV/WR NP	Nylon66 UL94V-0	02~20	1,000PCS/Bag
Housing	A2008H+NP	Nylon66 UL94V-0	02~20	1,000PCS/Bag
Terminal	A2008TF-P	Phosphor Bronze		10,000PCS/Reel

**A2013****2.00MM PITCH SERIES****SPECIFICATIONS**

- ※ Current Rating: 4A AC/DC
- ※ Voltage Rating: 125V AC/DC
- ※ Temperature Range: -25°C~+85°C
- ※ Contact Resistance: 10mΩ Max.
- ※ Insulation Resistance: 1000MΩ Min.
- ※ Withstanding Voltage: 1000V AC/minute
- ※ Wire Range: AWG#22~26

Item	Part No.	Material	Poles	QTY
Wafer	A2013WV/WR NP	Nylon66 UL94V-0	02~15	1,000PCS/Bag
Housing	A2013H+NP	Nylon66 UL94V-0	02~15	1,000PCS/Bag
Terminal	A2013TF-P	Phosphor Bronze		10,000PCS/Reel

**A2015 / 2016****2.00MM PITCH SERIES****SPECIFICATIONS**

- ※ Current Rating: 2A AC/DC
- ※ Voltage Rating: 250V AC/DC
- ※ Temperature Range: -25°C~+85°C
- ※ Contact Resistance: 20mΩ Max.
- ※ Insulation Resistance: 1000MΩ Min.
- ※ Withstanding Voltage: 1000V AC/minute
- ※ Wire Range: AWG#26~30

Item	Part No.	Material	Poles	QTY
Wafer	PH200VR(S)-(2)NP	PBT/Nylon6T UL94V-0	02~80	1,000PCS/Bag
Housing	A2015H+NP	Nylon66 UL94V-0	02~30	1,000PCS/Bag
Housing	A2016H(A)-2NP	Nylon66 UL94V-0	04~60	1,000PCS/Bag
Terminal	A2015TF-B	Brass		10,000PCS/Reel

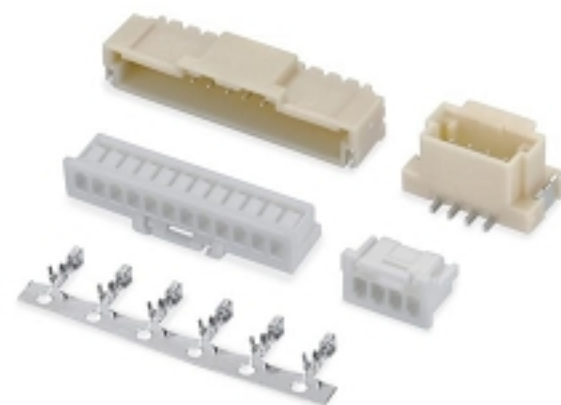

### A2018 2.00MM PITCH SERIES

#### SPECIFICATIONS

- ※ Current Rating: 3A AC/DC
- ※ Voltage Rating: 125V AC/DC
- ※ Temperature Range: -40°C~+105°C
- ※ Contact Resistance: 10mΩ Max.
- ※ Insulation Resistance: 1000MΩ Min.
- ※ Withstanding Voltage: 500V AC/minute
- ※ Wire Range: AWG#24~30

Item	Part No.	Material	Poles	QTY
Wafer	A2018W/S/WRS-NP	NylonBT,UL94V-0	02~15	600PCS/Reel
Housing	A2018H-NP-N0NA0	Nylon66 UL94V-0	02~15	1000PCS/Bag
Terminal	A2018TF-PT1	Phosphor Bronze		10,000PCS/Reel

### A2019 2.00MM PITCH SERIES

#### SPECIFICATIONS

- ※ Current Rating: 3A AC/DC
- ※ Voltage Rating: 250V AC/DC
- ※ Temperature Range: -40°C~+105°C
- ※ Contact Resistance: 10mΩ Max.
- ※ Insulation Resistance: 1000MΩ Min.
- ※ Withstanding Voltage: 800V AC/minute
- ※ Wire Range: AWG#26~28



Item	Part No.	Material	Poles	QTY
Wafer	A2019W/WRS-NP	Nylon66/PBT UL94V-0	02~15	1000PCS/Bag
Housing	A2019H-NP-N0CWT	Nylon66 UL94V-0	02~15	1000PCS/Bag



### A2022 2.54MM PITCH SERIES

#### SPECIFICATIONS

- ※ Current Rating: 3A AC/DC
- ※ Voltage Rating: 250V AC/DC
- ※ Temperature Range: -25°C~+85°C
- ※ Contact Resistance: 20mΩ Max.
- ※ Insulation Resistance: 1000MΩ Min.
- ※ Withstanding Voltage: 800V AC/minute
- ※ Wire Range: AWG#22~28

Item	Part No.	Material	Poles	QTY
Wafer	A2022W/WV-2NP	Nylon66 UL94V-0	08~40	1,000PCS/Bag
Housing	A2022H-2NP	Nylon66 UL94V-0	08~40	1,000PCS/Bag
Terminal	A2022TF-P	Phosphor Bronze		5,000PCS/Reel

### A2026 2.54MM PITCH SERIES

#### SPECIFICATIONS

- ※ Current Rating: 3A AC/DC
- ※ Voltage Rating: 250V AC/DC
- ※ Temperature Range: -40°C~+105°C
- ※ Contact Resistance: 20mΩ Max.
- ※ Insulation Resistance: 1000MΩ Min.
- ※ Withstanding Voltage: 800V AC/minute
- ※ Wire Range: AWG#22~26

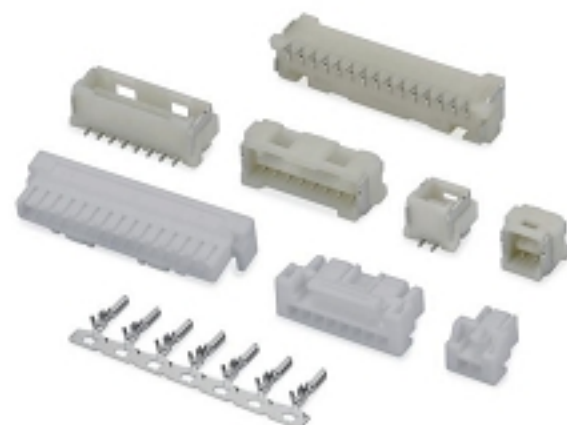

Item	Part No.	Material	Poles	QTY
Wafer	A2026WRS/WVS-NP	PA9T UL94V-0	02~15	950PCS/Reel
Housing	A2026H-NP	Nylon66 UL94V-0	02~15	1,000PCS/Bag
Terminal	A2026TF-P	Phosphor Bronze		8,000/Reel



**A2029****2.54MM PICH SERIES****SPECIFICATIONS**

- ※ Current Rating: 6.5A AC/DC
- ※ Voltage Rating: 250V AC/DC
- ※ Temperature Range: -25°C~+85°C
- ※ Contact Resistance: 20mΩ Max.
- ※ Insulation Resistance: 1000MΩ Min.
- ※ Withstanding Voltage: 800V AC/minute
- ※ Wire Range: AWG#20~26

Item	Part No.	Material	Poles	QTY
Wafer	A2029WRS-NP	PA4T UL94V-0	02-09	1,800PCS/Reel
Housing	A2029H-NP	Nylon66 UL94V-0	02-09	1,000PCS/Bag
Terminal	A2029TF-P	Phosphor Bronze		10,000PCS/Reel

**A2031****2.54MM PICH SERIES****SPECIFICATIONS**

- ※ Current Rating: 3A AC/DC
- ※ Voltage Rating: 250V AC/DC
- ※ Temperature Range: -25°C~+85°C
- ※ Contact Resistance: 10mΩ Max.
- ※ Insulation Resistance: 1000MΩ Min.
- ※ Withstanding Voltage: 800V AC/minute
- ※ Wire Range: AWG#22~28

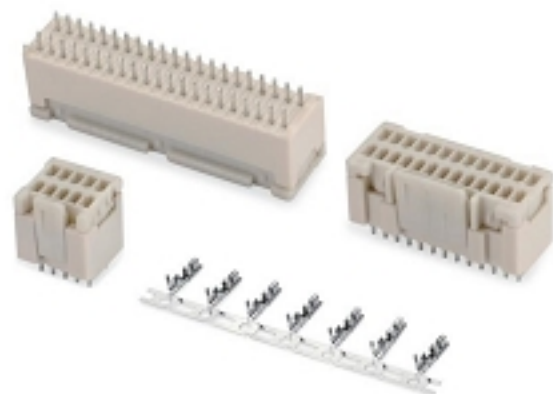

Item	Part No.	Material	Poles	QTY
Wafer	A2022WV/2NP	Nylon66 UL94V-0	06-40	50PCS/Tube
Housing	A2031H-2NP	Nylon66 UL94V-0	06-40	1,000PCS/Bag
Terminal	A2031TF-P	Phosphor Bronze		8,000PCS/Reel

**A2100****2.00MM PITCH SERIES****SPECIFICATIONS**

- ※ Current Rating: 3A AC/DC
- ※ Voltage Rating: 300V AC/DC
- ※ Temperature Range: -25°C~+85°C
- ※ Contact Resistance: 20mΩ Max.
- ※ Insulation Resistance: 100MΩ Min.
- ※ Withstanding Voltage: 1000V AC/minute
- ※ Wire Range: AWG#24~28

Item	Part No.	Material	Poles	QTY
Wafer	A2100WV/WR-NP	Nylon66 UL94V-0	02-15	1,000PCS/Bag
Housing	A2100H-NP	Nylon66 UL94V-0	02-15	1,000PCS/Bag
Terminal	A2100TF-P	Phosphor Bronze		10,000PCS/Reel

**A2211****2.00MM PITCH SERIES****SPECIFICATIONS**

- ※ Current Rating: 2A AC/DC
- ※ Voltage Rating: 250V AC/DC
- ※ Temperature Range: -25°C~+85°C
- ※ Contact Resistance: 30mΩ Max.
- ※ Insulation Resistance: 1000MΩ Min.
- ※ Withstanding Voltage: 800V AC/minute
- ※ Wire Range: AWG#22~30

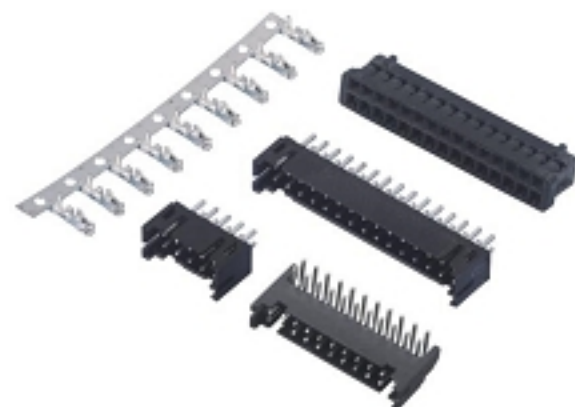

Item	Part No.	Material	Poles	QTY
Wafer	A2211WV/WRIS-2NP	Nylon66 BT UL94V-0	04-40	1,000PCS/Bag
Housing	A2211H/AI-2NP	Nylon66 UL94V-0	04-40	1,000PCS/Bag
Terminal	A2211TF-P	Phosphor Bronze		10,000PCS/Reel

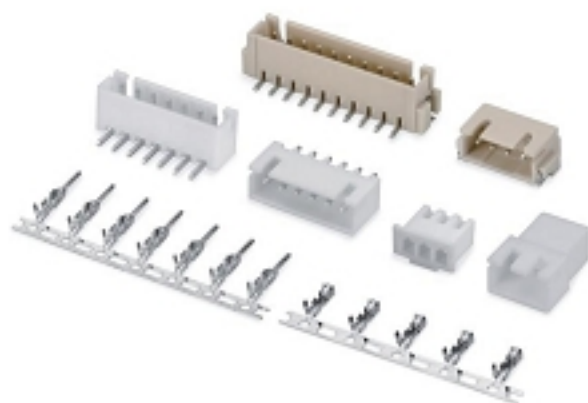

## A2501

### 2.50MM PITCH SERIES

#### SPECIFICATIONS

- ※ Current Rating: 3A AC/DC
- ※ Voltage Rating: 250V AC/DC
- ※ Temperature Range: -25°C~+85°C
- ※ Contact Resistance: 10mΩ Max.
- ※ Insulation Resistance: 1000MΩ Min.
- ※ Withstanding Voltage: 1000V AC/minute
- ※ Wire Range: AWG#22~28

Item	Part No.	Material	Poles	QTY
Wafer	A2501WV/R/VV/R/S-NP	Nylon66/Nylon9T UL94V-0	02~20	1,000PCS/Bag
Housing	A2501H/HM-NP	Nylon66 UL94V-0	02~20	1,000PCS/Bag
Terminal	A2501TF/TM-P/B	Phosphor Bronze/Brass		8,000PCS/Reel

## A2501HA/HB

### 2.50MM PITCH SERIES

#### SPECIFICATIONS

- ※ Current Rating: 3A AC/DC
- ※ Voltage Rating: 250V AC/DC
- ※ Temperature Range: -25°C~+85°C
- ※ Contact Resistance: 15mΩ Max.
- ※ Insulation Resistance: 1000MΩ Min.
- ※ Withstanding Voltage: 1000V AC/minute
- ※ Wire Range: AWG#22~28



Item	Part No.	Material	Poles	QTY
Wafer	A2501WV/R/A/B-NP	Nylon66 UL94V-0	02~25	1,000PCS/Bag
Housing	A2501HA/HB-NP	Nylon66 UL94V-0	02~25	1,000PCS/Bag
Terminal	A2501TFA-P	Phosphor Bronze		8,000PCS/Reel



## A2502

### 2.50MM PITCH SERIES

#### SPECIFICATIONS

- ※ Current Rating: 3A AC/DC
- ※ Voltage Rating: 250V AC/DC
- ※ Temperature Range: -25°C~+85°C
- ※ Contact Resistance: 10mΩ Max.
- ※ Insulation Resistance: 1000MΩ Min.
- ※ Withstanding Voltage: 800V AC/minute
- ※ Wire Range: AWG#22~30

Item	Part No.	Material	Poles	QTY
Wafer	A2502WV/R/NP	Nylon66 UL94V-0	02~15	1,000PCS/Bag
Housing	A2502H-NP	Nylon66 UL94V-0	02~15	1,000PCS/Bag
Terminal	A2502TF-P	Phosphor Bronze		8,000PCS/Reel

## A2503

### 2.50MM PITCH SERIES

#### SPECIFICATIONS

- ※ Current Rating: 3A AC/DC
- ※ Voltage Rating: 250V AC/DC
- ※ Temperature Range: -25°C~+85°C
- ※ Contact Resistance: 10mΩ Max.
- ※ Insulation Resistance: 1000MΩ Min.
- ※ Withstanding Voltage: 800V AC/minute
- ※ Wire Range: AWG#22~28

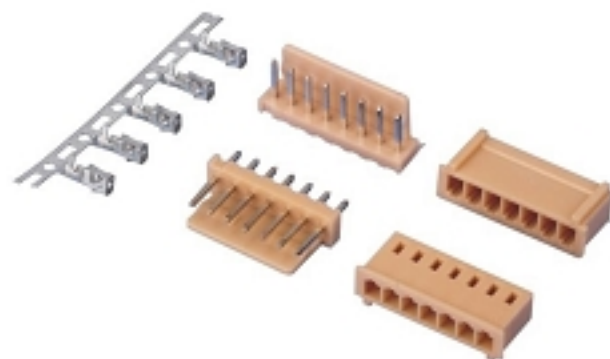

Item	Part No.	Material	Poles	QTY
Wafer	A2503WV/R/NP	Nylon66 UL94V-0	02~20	1,000PCS/Bag
Housing	A2503H-NP	Nylon66 UL94V-0	02~20	1,000PCS/Bag
Terminal	A2503TF-P	Phosphor Bronze		8,000PCS/Reel



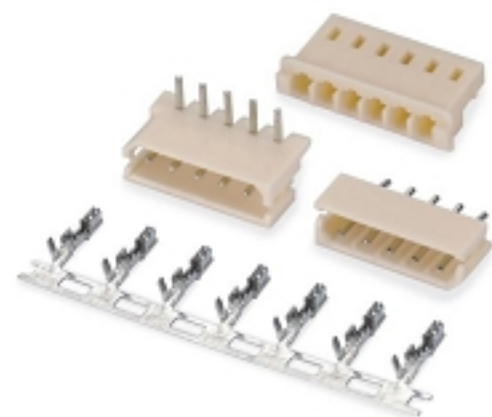

## A2506

### 2.50MM PITCH SERIES

#### SPECIFICATIONS

- ※ Current Rating: 3A AC/DC
- ※ Voltage Rating: 250V AC/DC
- ※ Temperature Range: -25°C~+85°C
- ※ Contact Resistance: 20mΩ Max.
- ※ Insulation Resistance: 1000MΩ Min.
- ※ Withstanding Voltage: 1000V AC/minute
- ※ Wire Range: AWG#22~28

Item	Part No.	Material	Poles	QTY
Wafer	A2506WV/WR-NP	Nylon66 UL94V-0	02~16	1,000PCS/Bag
Housing	A2506H-NP	Nylon66 UL94V-0	02~16	1,000PCS/Bag
Terminal	A2506TF-P	Phosphor Bronze		13,000PCS/Reel

## A2508

### 2.50MM PITCH SERIES

#### SPECIFICATIONS

- ※ Current Rating: 3A AC/DC
- ※ Voltage Rating: 250V AC/DC
- ※ Temperature Range: -25°C~+85°C
- ※ Contact Resistance: 10mΩ Max.
- ※ Insulation Resistance: 1000MΩ Min.
- ※ Withstanding Voltage: 1000V AC/minute
- ※ Wire Range: AWG#20~28



Item	Part No.	Material	Poles	QTY
Wafer	A2508WV/WR-NP	Nylon66 UL94V-0	02~20	1,000PCS/Bag
Housing	A2508H-NP	Nylon66 UL94V-0	02~20	1,000PCS/Bag
Terminal	A2508TF-P	Phosphor Bronze		8,000PCS/Reel

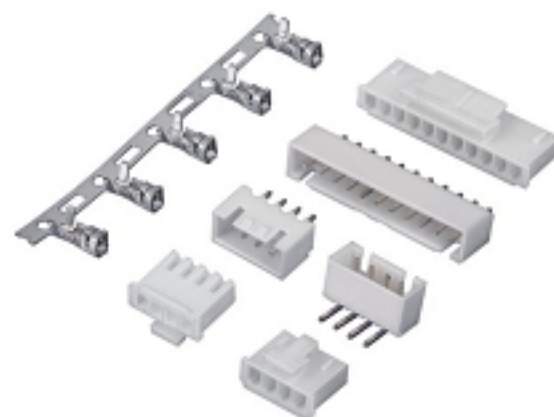

## A2515

### 2.50MM PITCH SERIES

#### SPECIFICATIONS

- ※ Current Rating: 3A AC/DC
- ※ Voltage Rating: 250V AC/DC
- ※ Temperature Range: -25°C~+85°C
- ※ Contact Resistance: 10mΩ Max.
- ※ Insulation Resistance: 1000MΩ Min.
- ※ Withstanding Voltage: 1000V AC/minute
- ※ Wire Range: AWG#22~28

Item	Part No.	Material	Poles	QTY
Wafer	A2515WV/WRB-NP	Nylon66 UL94V-0	02~20	1,000PCS/Bag
Housing	A2515HB-NP	Nylon66 UL94V-0	02~20	1,000PCS/Bag
Terminal	A2501TF-P	Phosphor Bronze		6,000PCS/Reel

## A2540

### 2.50MM PITCH SERIES

#### SPECIFICATIONS

- ※ Current Rating: 3A AC/DC
- ※ Voltage Rating: 250V AC/DC
- ※ Temperature Range: -25°C~+85°C
- ※ Contact Resistance: 10mΩ Max.
- ※ Insulation Resistance: 500MΩ Min.
- ※ Withstanding Voltage: 800V AC/minute
- ※ Wire Range: AWG#20~26

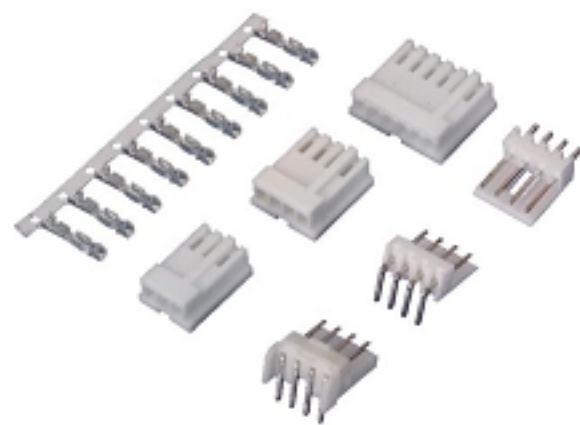

Item	Part No.	Material	Poles	QTY
Wafer	A2540WV/AI/WR/AI-NP	Nylon66 UL94V-0	02~15	1,000PCS/Bag
Housing	A2540H-NP	Nylon66 UL94V-0	02~15	1,000PCS/Bag
Terminal	A2540TF-P	Phosphor Bronze		10,000PCS/Reel

**A2541****2.54MM PITCH SERIES****SPECIFICATIONS**

- ※ Current Rating: 3A AC/DC
- ※ Voltage Rating: 250V AC/DC
- ※ Temperature Range: -25°C~+85°C
- ※ Contact Resistance: 20mΩ Max.
- ※ Insulation Resistance: 1000MΩ Min.
- ※ Withstanding Voltage: 1500V AC/minute
- ※ Wire Range: AWG#22~26

Item	Part No.	Material	Poles	QTY
Wafer	A2541WVJ(WV)RS-NP	PBT/Nylon4T UL94V-0	02~25	SMT/300PCS/Reel
Housing	A2541HF(HM)NP	PBT UL94V-0	02~25	1,000PCS/Bag
Terminal	A2541TF/TM-P	Phosphor Bronze		15,000PCS/Reel

**A2541HA****2.54MM PITCH SERIES****SPECIFICATIONS**

- ※ Current Rating: 3A AC/DC
- ※ Voltage Rating: 250V AC/DC
- ※ Temperature Range: -25°C~+85°C
- ※ Contact Resistance: <math>\leq 20\text{m}\Omega</math>
- ※ Insulation Resistance:  $\geq 1000\text{M}\Omega$  Min.
- ※ Withstanding Voltage: 1500V AC/minute
- ※ Wire Range: AWG#22~26

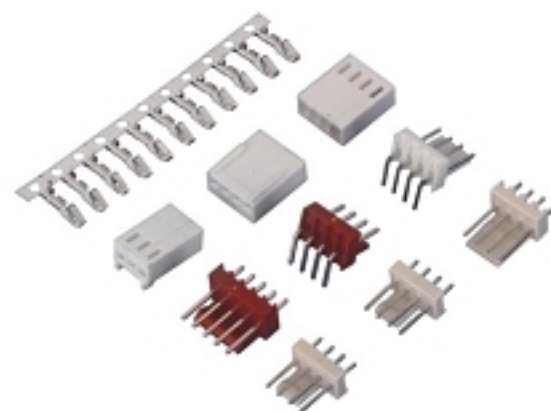

Item	Part No.	Material	Poles	QTY
Wafer	A2541WV(WV)RA-2NP	PBT UL94V-0	06~64	1,000PCS/Bag
Housing	A2541HA(B/C/D/E)-2NP	PBT UL94V-0	06~64	1,000PCS/Bag
Terminal	A2541TF-P	Phosphor Bronze		15,000PCS/Reel

**A2542****2.54MM PITCH SERIES****SPECIFICATIONS**

- ※ Current Rating: 4A AC/DC
- ※ Voltage Rating: 250V AC/DC
- ※ Temperature Range: -25°C~+85°C
- ※ Contact Resistance: 10mΩ Max.
- ※ Insulation Resistance: 1000MΩ Min.
- ※ Withstanding Voltage: 1000V AC/minute
- ※ Wire Range: AWG#24~30

Item	Part No.	Material	Poles	QTY
Wafer	A2542WV(X)J(WR)X-NP	Nylon66 UL94V-0	02~20	1,000PCS/Bag
Housing	A2542HXJ-NP	Nylon66 UL94V-0	02~20	1,000PCS/Bag
Terminal	A2542TF-P	Phosphor Bronze		10,000PCS/Reel

**A2543****2.54MM PITCH SERIES****SPECIFICATIONS**

- ※ Current Rating: 3A AC/DC
- ※ Voltage Rating: 250V AC/DC
- ※ Temperature Range: -40°C~+105°C
- ※ Contact Resistance: 20mΩ Max.
- ※ Insulation Resistance: 1000MΩ Min.
- ※ Withstanding Voltage: 1000V AC/minute
- ※ Wire Range: AWG#22~26



Item	Part No.	Material	Poles	QTY
Wafer	A2543WV(A)W(R)A(Z)NP	PBT UL94V-0	02~64	1,000PCS/Bag
Housing	A2543HF(A)H(M)A(Z)NP	PBT UL94V-0	02~64	1,000PCS/Bag
Terminal	A2543TF(A)T(M)A-P	Phosphor Bronze		15,000PCS/Reel



**A2544H**

HRS HIF 2.54MM PITCH SERIES

**SPECIFICATIONS**

- ※ Current Rating: 3A AC/DC
- ※ Voltage Rating: 250V AC/DC
- ※ Temperature Range: -25°C~+85°C
- ※ Contact Resistance: 20mΩ Max.
- ※ Insulation Resistance: 1000MΩ Min.
- ※ Withstanding Voltage: 1500V AC/minute
- ※ Wire Range: AWG#22~26

Item	Part No.	Material	Poles	QTY
Wafer	A2544W/D0/WRD0-2NP	PBT UL94V-0	04-64	1,000PCS/Bag
Housing	A2544HA/B/C-2NP	PBT UL94V-0	04-64	1,000PCS/Bag
Terminal	A2544TF-P	Phosphor Bronze		10,000PCS/Reel

**A2544W**2.54MM PITCH EJECTOR  
HEADER SERIES**SPECIFICATIONS**

- ※ Current Rating: 3A AC/DC
- ※ Voltage Rating: 250V AC/DC
- ※ Temperature Range: -25°C~+85°C
- ※ Contact Resistance: 20mΩ Max.
- ※ Insulation Resistance: 1000MΩ Min.
- ※ Withstanding Voltage: 1500V AC/minute



Item	Part No.	Material	Poles	QTY
Wafer	A2544W/D0/WRD0-2NP	PBT UL94V-0	04-64	300PCS/Bag
Housing	A2544HA/B/C-2NP	PBT UL94V-0	04-64	1,000PCS/Bag

**A2545**

2.54MM PITCH SERIES

**SPECIFICATIONS**

- ※ Current Rating: 3A AC/DC
- ※ Voltage Rating: 250V AC/DC
- ※ Temperature Range: -25°C~+85°C
- ※ Contact Resistance: 20mΩ Max.
- ※ Insulation Resistance: 1000MΩ Min.
- ※ Withstanding Voltage: 1500V AC/minute
- ※ Wire Range: AWG#22~26

Item	Part No.	Material	Poles	QTY
Wafer	PH254V/S/R/S-NP	PBT/Nylon6T UL94V-0	01-40	1,000PCS/Bag
Housing	A2545H-NP	PBT/Nylon66 UL94V-0	01-40	1,000PCS/Bag
Terminal	A2545TF/TM-B	Brass		10,000PCS/Reel

**A2546**

2.54MM PITCH SERIES

**SPECIFICATIONS**

- ※ Current Rating: 3A AC/DC
- ※ Voltage Rating: 250V AC/DC
- ※ Temperature Range: -25°C~+85°C
- ※ Contact Resistance: 20mΩ Max.
- ※ Insulation Resistance: 1000MΩ Min.
- ※ Withstanding Voltage: 1500V AC/minute
- ※ Wire Range: AWG#22~26

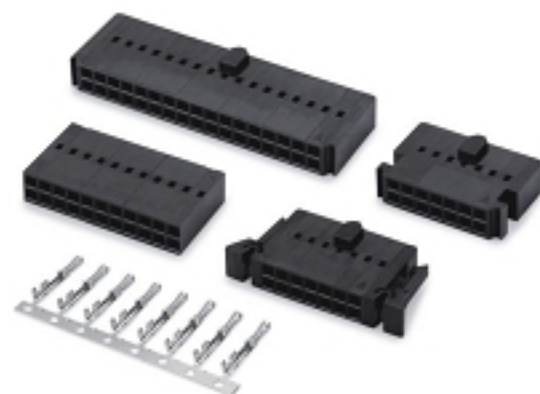

Item	Part No.	Material	Poles	QTY
Wafer	PH254V/S/R/S-2NP	PBT/Nylon6T UL94V-0	04-80	1,000PCS/Bag
Housing	A2546H/HA-2NP	PBT/Nylon66 UL94V-0	04-80	1,000PCS/Bag
Terminal	A2545TF-B	Brass		10,000PCS/Reel

**A2547****2.54MM PITCH SERIES****SPECIFICATIONS**

- ※ Current Rating: 3A AC/DC
- ※ Voltage Rating: 250V AC/DC
- ※ Temperature Range: -25°C~+85°C
- ※ Contact Resistance: Initial value 10mΩ
- ※ Insulation Resistance: 1000MΩ Min.
- ※ Withstanding Voltage: 1000V AC/minute
- ※ Wire Range: AWG#22~30

Item	Part No.	Material	Poles	QTY
Wafer	A2544WV/WR-2NP	PBT UL94V-0	04-64	1,000PCS/Bag
Housing	A2547HA/HB/C/D-2NP	PBT UL94V-0	04-64	1,000PCS/Bag
Terminal	A2541TF-P	Phosphor Bronze		15,000PCS/Reel

**A2549****2.54MM PITCH SERIES****SPECIFICATIONS**

- ※ Current Rating: 3A AC/DC
- ※ Voltage Rating: 250V AC/DC
- ※ Temperature Range: -25°C~+85°C
- ※ Contact Resistance: 20mΩ Max.
- ※ Insulation Resistance: 1000MΩ Min.
- ※ Withstanding Voltage: 800V AC/minute
- ※ Wire Range: AWG#24~28

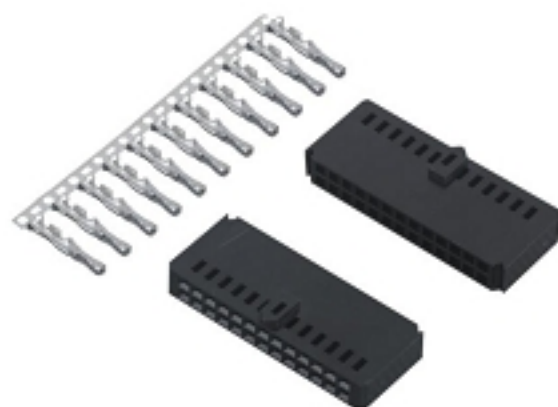

Item	Part No.	Material	Poles	QTY
Wafer	A2544WV/WR-2NP	PBT UL94V-0	04-64	1,000PCS/Bag
Housing	A2549H/HB/HB-2NP	Nylon66 UL94V-2	04-64	1,000PCS/Bag
Terminal	A2540TF-P	Phosphor Bronze		15,000PCS/Reel

**A2553****2.54MM PITCH SERIES****SPECIFICATIONS**

- ※ PCSCurrent Rating: 3A AC/DC
- ※ Voltage Rating: 250V AC/DC
- ※ Temperature Range: -25°C~+85°C
- ※ Contact Resistance: 20mΩ Max.
- ※ Insulation Resistance: 1000MΩ Min.
- ※ Withstanding Voltage: 800V AC/minute
- ※ Wire Range: AWG#22~26

Item	Part No.	Material	Poles	QTY
Wafer	A2544WV/WR/DX-2NP	6T/PBT UL94V-0	08-64	Plastic Tray
Housing	A2553H-2N	PBT UL94V-0	08-64	1,000PCS/Bag
Terminal	C2553TF-P	Phosphor Bronze		10,000PCS/Reel

**A3500****3.50MM PITCH SERIES****SPECIFICATIONS**

- ※ Current Rating: 1A AC/DC
- ※ Voltage Rating: 1400V AC/DC
- ※ Temperature Range: -25°C~+85°C
- ※ Contact Resistance: 10mΩ Max.
- ※ Insulation Resistance: 1000MΩ Min.
- ※ Withstanding Voltage: 3800V AC/minute
- ※ Wire Range: AWG#24~28

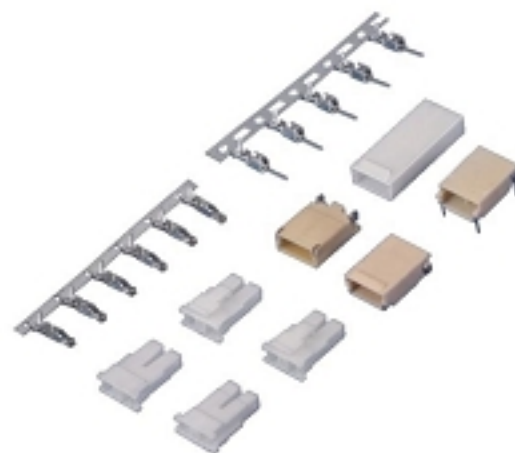

Item	Part No.	Material	Poles	QTY
Wafer	A3500WRS/RA/SI-02	Nylon6T UL94V-0	02	1,000PCS/Bag
Housing	A3500HF/HM-02	Nylon66 UL94V-0	02	1,000PCS/Bag
Terminal	A3500TF/TM-P	Phosphor Bronze		8,000PCS/Reel



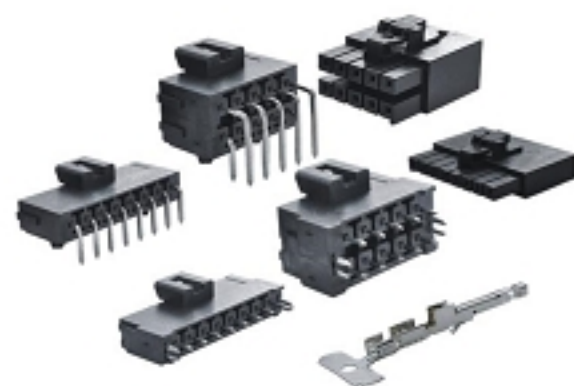

### A3501

#### 3.5MM PITCH SERIES

#### SPECIFICATIONS

- ※ Current Rating: 14A AC/DC
- ※ Voltage Rating: 400V AC/DC
- ※ Temperature Range: -40°C~+105°C
- ※ Contact Resistance: 10mΩ Max.
- ※ Insulation Resistance: 1000MΩ Min.
- ※ Withstanding Voltage: 1800V AC/minute
- ※ Wire Range: AWG#16~22

Item	Part No.	Material	Poles	QTY
Housing	A3501H-I2/NP	Nylon4T UL94V-0	02~16	1,000PCS/Bag
Terminal	A3501TF-P	Phosphor Bronze		5,000PCS/Reel
Wafer	A3501WR/WV-Q2/NP	LCP UL94V-0	02~16	1,000PCS/Bag

### A3960

#### 3.96MM PITCH SERIES

#### SPECIFICATIONS

- ※ Current Rating: 7A AC/DC
- ※ Voltage Rating: 250V AC/DC
- ※ Temperature Range: -25°C~+85°C
- ※ Contact Resistance: 10mΩ Max.
- ※ Insulation Resistance: 1000MΩ Min.
- ※ Withstanding Voltage: 1500V AC/minute
- ※ Wire Range: AWG#18~24

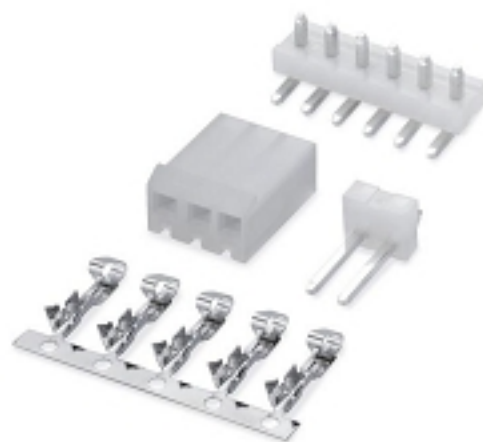

Item	Part No.	Material	Poles	QTY
Wafer	A3960W/WR NP	Nylon66 UL94V-2	02~20	1,000PCS/Bag
Housing	A3960H-NP	Nylon66 UL94V-2	02~20	1,000PCS/Bag
Terminal	A3960TF-P	Phosphor Bronze		5,000PCS/Reel



### A3961

#### 3.96MM PITCH SERIES

#### SPECIFICATIONS

- ※ Current Rating: 7A AC/DC
- ※ Voltage Rating: 250V AC/DC
- ※ Temperature Range: -25°C~+85°C
- ※ Contact Resistance: 10mΩ Max.
- ※ Insulation Resistance: 1000MΩ Min.
- ※ Withstanding Voltage: 1500V AC/minute
- ※ Wire Range: AWG#18~22

Item	Part No.	Material	Poles	QTY
Wafer	A3961W/WR NP	Nylon66 UL94V-0	02~15	1,000PCS/Bag
Housing	A3961H-NP	Nylon66 UL94V-0	02~15	1,000PCS/Bag
Terminal	A3961TF-P	Phosphor Bronze		3,000PCS/Reel

### A4000

#### 4.00MM PITCH SERIES

#### SPECIFICATIONS

- ※ Current Rating: 1A AC/DC
- ※ Voltage Rating: 600V AC/DC
- ※ Temperature Range: -25°C~+85°C
- ※ Contact Resistance: 10mΩ Max.
- ※ Insulation Resistance: 1000MΩ Min.
- ※ Withstanding Voltage: 1800V AC/minute
- ※ Wire Range: AWG#22~28

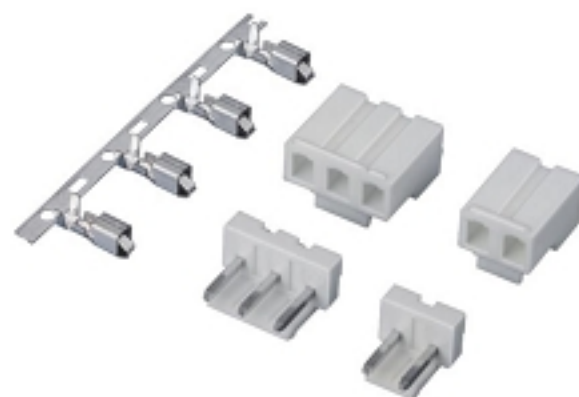

Item	Part No.	Material	Poles	QTY
Wafer	A4000W/WRS NP	Nylon6T UL94V-0	02~05	1,000PCS/Bag
Housing	A4000H/HM NP	Nylon66 UL94V-0	02~05	1,000PCS/Bag
Terminal	A4000TF/TM-P	Phosphor Bronze/Brass		3,500PCS/Reel

**A5000****5.00MM PITCH SERIES****SPECIFICATIONS**

- ※ Current Rating: 7A AC/DC
- ※ Voltage Rating: 250V AC/DC
- ※ Temperature Range: -25°C~+85°C
- ※ Contact Resistance: 10mΩ
- ※ Insulation Resistance: 1000MΩ Min.
- ※ Withstanding Voltage: 1500V AC/minute
- ※ Wire Range: AWG#18~24

Item	Part No.	Material	Poles	QTY
Wafer	A5000WV/WR-NP	Nylon66 UL94V-0	02-04	500PCS/Bag
Housing	A5000H-NP	Nylon66 UL94V-0	02-04	1,000PCS/Bag
Terminal	A5000TF-P	Phosphor Bronze		2,500PCS/Reel

**A5001****5.00MM PITCH SERIES****SPECIFICATIONS**

- ※ Current Rating: 7A AC/DC
- ※ Voltage Rating: 250V AC/DC
- ※ Temperature Range: -25°C~+85°C
- ※ Contact Resistance: 10mΩ Max.
- ※ Insulation Resistance: 1000MΩ Min.
- ※ Withstanding Voltage: 1500V AC/minute
- ※ Wire Range: AWG#18-24



Item	Part No.	Material	Poles	QTY
Wafer	A5001WV/NP	Nylon66 UL94V-0	02-08	100PCS/Bag
Housing	A5001H-NP	Nylon66 UL94V-0	02-08	100PCS/Bag
Terminal	A5001TF-P	Phosphor Bronze		5,000PCS/Reel

**A5081****5.08MM PITCH SERIES****SPECIFICATIONS**

- ※ Current Rating: 7A AC/DC
- ※ Voltage Rating: 250V AC/DC
- ※ Temperature Range: -25°C~+85°C
- ※ Contact Resistance: 10mΩ Max.
- ※ Insulation Resistance: 1000MΩ Min.
- ※ Withstanding Voltage: 1500V AC/minute
- ※ Wire Range: AWG#18~24

Item	Part No.	Material	Poles	QTY
Wafer	A5081WV/WR-NP	Nylon66 UL94V-2	02-20	1,000PCS/Bag
Housing	A5081H-NP	Nylon66 UL94V-2	02-20	1,000PCS/Bag
Terminal	A3980TF-P	Phosphor Bronze		5,000PCS/Reel

**A7500****7.50MM PITCH SERIES****SPECIFICATIONS**

- ※ Current Rating: 5A AC/DC
- ※ Voltage Rating: 250V AC/DC
- ※ Temperature Range: -25°C~+85°C
- ※ Contact Resistance: 10mΩ Max.
- ※ Insulation Resistance: 1000MΩ Min.
- ※ Withstanding Voltage: 1500V AC/minute
- ※ Wire Range: AWG#18~24



Item	Part No.	Material	Poles	QTY
Wafer	A7500WV/NP	Nylon66 UL94V-0	01-08	1,000PCS/Bag
Housing	A7500H-NP	Nylon66 UL94V-0	01-08	1,000PCS/Bag
Terminal	A7500TF-P	Phosphor Bronze		3,000PCS/Reel



**A7920****7.92MM PITCH SERIES****SPECIFICATIONS**

- ※ Current Rating: 7A AC/DC
- ※ Voltage Rating: 250V AC/DC
- ※ Temperature Range: -25°C~+85°C
- ※ Contact Resistance: 10mΩ Max.
- ※ Insulation Resistance: 1000MΩ Min.
- ※ Withstanding Voltage: 1500V AC/minute
- ※ Wire Range: AWG#18~24

Item	Part No.	Material	Poles	QTY
Wafer	A7920WV1R0-NP	Nylon66 UL94V-2	02-10	1,000PCS/Bag
Housing	A3900H-NP	Nylon66 UL94V-2	02-10	1,000PCS/Bag
Terminal	A3900TF-P	Phosphor Bronze		5,000PCS/Reel

**A7921****7.92MM PITCH SERIES****SPECIFICATIONS**

- ※ Current Rating: 7A AC/DC
- ※ Voltage Rating: 250V AC/DC
- ※ Temperature Range: -25°C~+85°C
- ※ Contact Resistance: 10mΩ Max.
- ※ Insulation Resistance: 1000MΩ Min.
- ※ Withstanding Voltage: 1500V AC/minute
- ※ Wire Range: AWG#18~22



Item	Part No.	Material	Poles	QTY
Wafer	A7921WV1R0-NP	Nylon66 UL94V-0	02-08	1,000PCS/Bag
Housing	A3061H-NP	Nylon66 UL94V-0	02-08	1,000PCS/Bag
Terminal	A3061TF-P	Phosphor Bronze		3,000PCS/Reel

**B0800****0.80MM PITCH SERIES****SPECIFICATIONS**

- ※ Current Rating: 0.5A AC/DC
- ※ Voltage Rating: 60V AC/DC
- ※ Temperature Range: -25°C~+85°C
- ※ Contact Resistance: 60mΩ Max.
- ※ Insulation Resistance: 800MΩ Min.
- ※ Withstanding Voltage: 500V AC/minute
- ※ After environmental testing: 60mΩ Max

Item	Part No.	Material	Poles	QTY
Wafer	B0800WVFS/WVMS-NP	PA9T UL94V-0	04-100	1,000/Reel

**B1259****1.25MM PITCH SERIES****SPECIFICATIONS**

- ※ Current Rating: 1A AC/DC
- ※ Voltage Rating: 125V AC/DC
- ※ Temperature Range: -25°C~+85°C
- ※ Contact Resistance: 20mΩ Max.
- ※ Insulation Resistance: 100MΩ Min.
- ※ Withstanding Voltage: 500V AC/minute
- ※ Wire Range: AWG#28~32



Item	Part No.	Material	Poles	QTY
Housing	B1259H-NP	Nylon66 UL94V-0	02-15	1,000PCS/Bag
Terminal	B1259TV-P	Phosphor Bronze		15,000PCS/Reel

**B1502****1.50MM PITCH SERIES****SPECIFICATIONS**

- ※ Current Rating: 1A AC/DC
- ※ Voltage Rating: 200V AC/DC
- ※ Temperature Range: -25°C~+85°C
- ※ Contact Resistance: 20mΩ Max.
- ※ Insulation Resistance: 500MΩ Min.
- ※ Withstanding Voltage: 500V AC/minute
- ※ Wire Range: AWG#28~30

Item	Part No.	Material	Poles	QTY
Housing	B1502HV/HRNP	Nylon66 UL94V-0	02~15	1,000PCS/Bag
Terminal	B1502TV/TRP	Phosphor Bronze/Brass		10,000PCS/Reel

**B2011****2.00MM PITCH SERIES****SPECIFICATIONS**

- ※ Current Rating: 2A AC/DC
- ※ Voltage Rating: 250V AC/DC
- ※ Temperature Range: -25°C~+85°C
- ※ Contact Resistance: 20mΩ Max.
- ※ Insulation Resistance: 1000MΩ Min.
- ※ Withstanding Voltage: 800V AC/minute
- ※ Wire Range: AWG#24~30



Item	Part No.	Material	Poles	QTY
Housing	B2011HV/HRNP	Nylon66 UL94V-0	02~16	1,000PCS/Bag
Terminal	B2011TV/TRP	Phosphor Bronze/Brass		15,000PCS/Reel

**B2512****2.50MM PITCH SERIES****SPECIFICATIONS**

- ※ Current Rating: 3A AC/DC
- ※ Voltage Rating: 250V AC/DC
- ※ Temperature Range: -25°C~+85°C
- ※ Contact Resistance: 10mΩ Max.
- ※ Insulation Resistance: 1000MΩ Min.
- ※ Withstanding Voltage: 800V AC/minute
- ※ Wire Range: AWG#22~28

Item	Part No.	Material	Poles	QTY
Housing	B2512HV/HRNP	Nylon66 UL94V-0	02~16	1,000PCS/Bag
Terminal	B2512TV/TRP/B	Phosphor Bronze/Brass		12,000PCS/Reel

**B2550****2.54MM PITCH IC SERIES****SPECIFICATIONS**

- ※ Current Rating: 3A AC/DC
- ※ Voltage Rating: 60V AC/DC
- ※ Temperature Range: -40°C~+105°C
- ※ Contact Resistance: 4mΩ Max.
- ※ Insulation Resistance: 1000MΩ Min.
- ※ Withstanding Voltage: 500V AC/minute

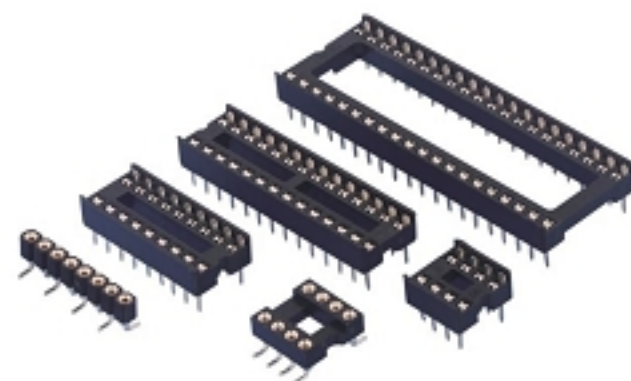

Item	Part No.	Material	Poles	QTY
Wafer	B2550WV/VB/S-2NP	PPS,UL94V-0	02~48	1,000PCS/Bag

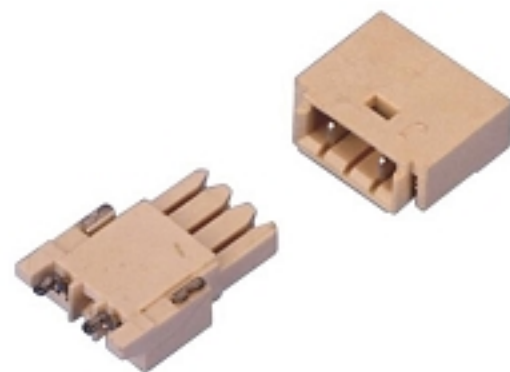

**B3000****3.00MM PITCH SERIES****SPECIFICATIONS**

- ※ Current Rating: 1A AC/DC
- ※ Voltage Rating: 150V AC/DC
- ※ Temperature Range: -25°C~+85°C
- ※ Contact Resistance: 20mΩ Max.
- ※ Insulation Resistance: 500MΩ Min.
- ※ Withstanding Voltage: 1000V AC/minute

Item	Part No.	Material	Poles	QTY
Wafer	B3000WRFS/WRMS-NP	LCP UL94V-0	02	1,800PCS/Reel

**B3965****3.96MM PITCH SERIES****SPECIFICATIONS**

- ※ Current Rating: 3A AC/DC
- ※ Voltage Rating: 250V AC/DC
- ※ Temperature Range: -25°C~+85°C
- ※ Contact Resistance: 10mΩ Max.
- ※ Insulation Resistance: 1000MΩ Min.
- ※ Withstanding Voltage: 800V AC/minute
- ※ Wire Range: AWG#22~28

Item	Part No.	Material	Poles	QTY
Housing	B3965HVAJ-NP	Nylon66 UL94V-0	02-16	1,000PCS/Bag
Terminal	B3965TVAJ-B/P	Brass/Phosphor Bronze		5,000PCS/Reel

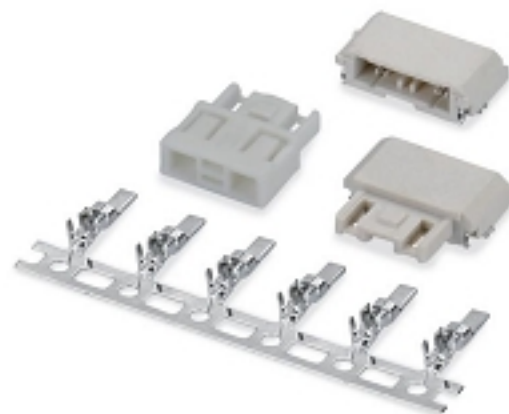
**B4000****4.00MM PITCH SERIES****SPECIFICATIONS**

- ※ Current Rating: 3A AC/DC
- ※ Voltage Rating: 300V AC/DC
- ※ Temperature Range: -25°C~+85°C
- ※ Contact Resistance: 20mΩ Max.
- ※ Insulation Resistance: 1000MΩ Min.
- ※ Withstanding Voltage: 1700V AC/minute

Item	Part No.	Material	Poles	QTY
Wafer	B4000WRFS/WRMS-NP	LCP UL94V-0	02	1,800PCS/Reel

**C2003****2.00MM PITCH SERIES****SPECIFICATIONS**

- ※ Current Rating: 2A AC/DC
- ※ Voltage Rating: 125V AC/DC
- ※ Temperature Range: -25°C~+85°C
- ※ Contact Resistance: 20mΩ Max.
- ※ Insulation Resistance: 1000MΩ Min.
- ※ Withstanding Voltage: 500V AC/minute
- ※ Wire Range: AWG#24~28

Item	Part No.	Material	Poles	QTY
Housing	C2003HF/HM-NP	Nylon66 UL94V-0	02-13	1,000PCS/Bag
Terminal	C2003TF/TM-P	Phosphor Bronze		10,000PCS/Reel

**C2013****2.0MM PICH SERIES****SPECIFICATIONS**

- ※ Current Rating: 3A AC/DC
- ※ Voltage Rating: 100V AC/DC
- ※ Temperature Range: -55°C~+85°C
- ※ Contact Resistance: 10mΩ Max.
- ※ Insulation Resistance: 1000MΩ Min.
- ※ Withstanding Voltage: 1000V AC/minute
- ※ Wire Range: AWG#22-26

Item	Part No.	Material	Poles	QTY
Housing	C2013WVF-2NP/NP	PBT UL94V-0	02-08	1,000PCS/Bag
Terminal	C2013HF-2NP/NP	PBT UL94V-0	02-08	1,000PCS/Bag
Terminal	C2013TM-P	Phosphor Bronze		8,200PCS/Reel

**C2505****2.50MM PITCH SERIES****SPECIFICATIONS**

- ※ Current Rating: 3A AC/DC
- ※ Voltage Rating: 250V AC/DC
- ※ Temperature Range: -25°C~+85°C
- ※ Contact Resistance: 10mΩ Max.
- ※ Insulation Resistance: 500MΩ Min.
- ※ Withstanding Voltage: 1500V AC/minute
- ※ Wire Range: AWG#22~28

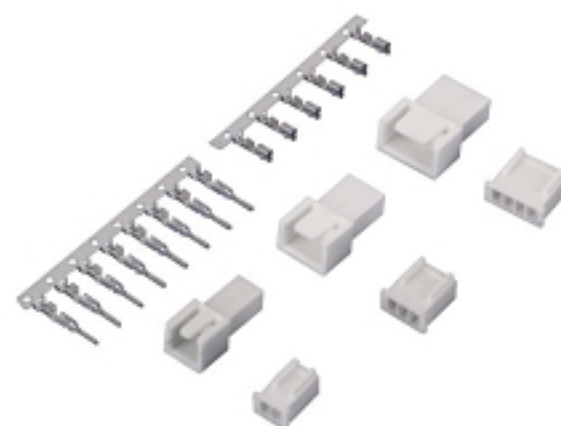

Item	Part No.	Material	Poles	QTY
Housing	C2505HF/HM-NP/2NP	Nylon66 UL94V-0	02-12	1,000PCS/Bag
Terminal	C2505TF-P/B	Phosphor Bronze/Bress		5,000PCS/Reel
Terminal	C2505TM-P/B	Phosphor Bronze/Bress		10,000PCS/Reel

**C2509****2.50MM PITCH SERIES****SPECIFICATIONS**

- ※ Current Rating: 3A AC/DC
- ※ Voltage Rating: 250V AC/DC
- ※ Temperature Range: -25°C~+85°C
- ※ Contact Resistance: 20mΩ Max.
- ※ Insulation Resistance: 1000MΩ Min.
- ※ Withstanding Voltage: 1000V AC/minute
- ※ Wire Range: AWG#22~28

Item	Part No.	Material	Poles	QTY
Housing	C2509HM/HF-NP	Nylon66 UL94V-0	02-12	1,000PCS/Bag
Terminal	C2509TF/TM-P	Phosphor Bronze		10,000PCS/Reel

**C2510****2.50MM PITCH SERIES****SPECIFICATIONS**

- ※ Current Rating: 1A AC/DC
- ※ Voltage Rating: 130V AC/DC
- ※ Temperature Range: -25°C~+85°C
- ※ Contact Resistance: 20mΩ Max.
- ※ Insulation Resistance: 1000MΩ Min.
- ※ Withstanding Voltage: 800V AC/minute
- ※ Wire Range: AWG#26~30

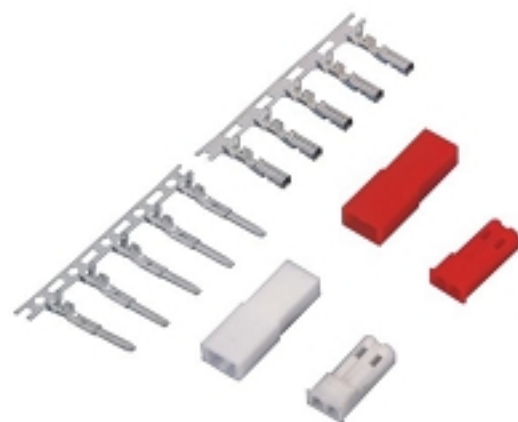

Item	Part No.	Material	Poles	QTY
Housing	C2510HM/HF-02	Nylon66 UL94V-0	02	1,000PCS/Bag
Terminal	C2510TF/TM-P	Phosphor Bronze		8,000PCS/Reel



**C2511****2.50MM PITCH SERIES****SPECIFICATIONS**

- ※ Current Rating: 3A AC/DC
- ※ Voltage Rating: 250V AC/DC
- ※ Temperature Range: -25°C~+85°C
- ※ Contact Resistance: 20mΩ Max.
- ※ Insulation Resistance: 1000MΩ Min.
- ※ Withstanding Voltage: 1000V AC/minute
- ※ Wire Range: AWG#22~30

Item	Part No.	Material	Poles	QTY
Housing	C2511HM/HF-NP	Nylon66 UL94V-0	02~12	1,000PCS/Bag
Terminal	C2511TF/TM-P	Phosphor Bronze		10,000PCS/Reel

**C2805****4.00MM PICH SERIES****SPECIFICATIONS**

- ※ Current Rating: 8A AC/DC
- ※ Voltage Rating: 250V AC/DC
- ※ Temperature Range: -25°C~+85°C
- ※ Contact Resistance: 10mΩ Max.
- ※ Insulation Resistance: 1000MΩ Min.
- ※ Withstanding Voltage: 1000V AC/minute

Item	Part No.	Material	Poles	QTY
Housing	C2805HF-3NP	Nylon UL94V-0	03~09	1,000PCS/Bag
Terminal	C2805HM-3NP	Nylon UL94V-0	03~09	1,000PCS/Reel
Terminal	C2805TF/M-XX	Brass		4,500PCS/Reel

**C3030****3.0MM SINGLE ROW SERIES****SPECIFICATIONS**

- ※ Current Rating: 5A AC/DC
- ※ Voltage Rating: 250V AC/DC
- ※ Temperature Range: -25°C~+85°C
- ※ Contact Resistance: 10mΩ Max.
- ※ Insulation Resistance: 1000MΩ Min.
- ※ Withstanding Voltage: 1500V AC/minute
- ※ Wire Range: AWG#20~24

Item	Part No.	Material	Poles	QTY
Wafer	C3030W/WRX/S-NP	PBT/LCP UL94V-0	02~12	300PCS/Reel
Housing	C3030HF-HMX-NP	Nylon66 UL94V-0(2)	02~12	1,000PCS/Bag
Terminal	C3030TF-P	Phosphor Bronze		10,000PCS/Reel

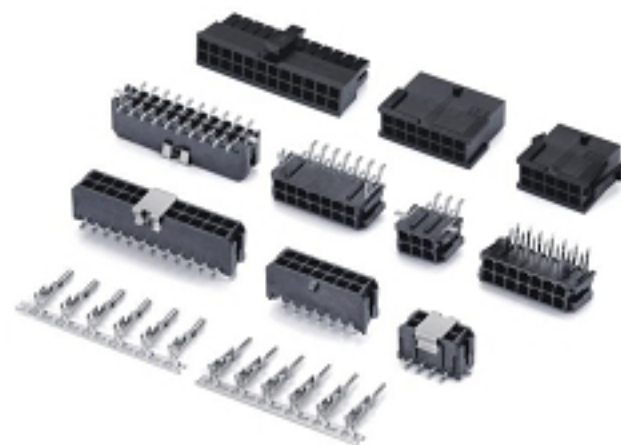
**C3030****3.0MM DUAL ROW SERIES****SPECIFICATIONS**

- ※ Current Rating: 5A AC/DC
- ※ Voltage Rating: 250V AC/DC
- ※ Temperature Range: -25°C~+85°C
- ※ Contact Resistance: 10mΩ Max.
- ※ Insulation Resistance: 1000MΩ Min.
- ※ Withstanding Voltage: 1500V AC/minute
- ※ Wire Range: AWG#20~24

Item	Part No.	Material	Poles	QTY
Wafer	C3030W/WRX/S-2NP	PBT/LCP UL94V-0	02~24	1,000PCS/Bag
Housing	C3030HF-HMX-2NP	Nylon66 UL94V-0(2)	02~24	1,000PCS/Bag
Terminal	C3030TM/TF-P	Phosphor Bronze		10,000PCS/Reel

**C3680****3.68MM PITCH SERIES****SPECIFICATIONS**

- ※ Current Rating: 3A AC/DC
- ※ Voltage Rating: 250V AC/DC
- ※ Temperature Range: -25°C~+85°C
- ※ Contact Resistance: 20mΩ Max.
- ※ Insulation Resistance: 1000MΩ Min.
- ※ Withstanding Voltage: 1000V AC/minute
- ※ Wire Range: AWG#22~28

Item	Part No.	Material	Poles	QTY
Housing	C3680HF/HM-NP	Nylon66 UL94V-2	02~12	1,000PCS/Bag
Terminal	C3680TF/TMP	Phosphor Bronze		5,000PCS/Reel

**C3962****3.96MM PICH SERIES****SPECIFICATIONS**

- ※ Current Rating: 8A AC/DC
- ※ Voltage Rating: 250V AC/DC
- ※ Temperature Range: -25°C~+85°C
- ※ Contact Resistance: 15mΩ Max.
- ※ Insulation Resistance: 1000MΩ Min.
- ※ Withstanding Voltage: 1500V AC/minute
- ※ Wire Range: AWG#18-22

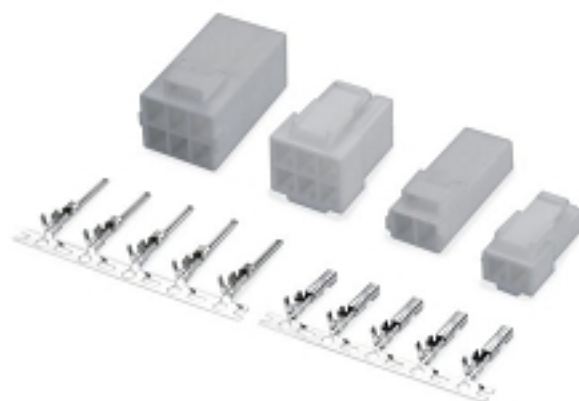

Item	Part No.	Material	Poles	QTY
Wafer	C3962HM-01	Nylon66 UL94V-0	01	1,000PCS/Bag
Housing	C3962HF-01	Nylon66 UL94V-0	01	1,000PCS/Bag
Terminal	C3962TF/TMP1	Phosphor Bronze		6,000PCS/Reel

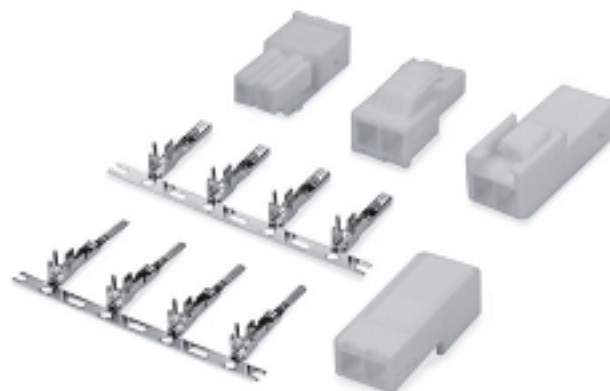
**C3963****3.96MM PICH SERIES****SPECIFICATIONS**

- ※ Current Rating: 8A AC/DC
- ※ Voltage Rating: 250V AC/DC
- ※ Temperature Range: -25°C~+85°C
- ※ Contact Resistance: 15mΩ Max.
- ※ Insulation Resistance: 1000MΩ Min.
- ※ Withstanding Voltage: 1500V AC/minute
- ※ Wire Range: AWG#16-20

Item	Part No.	Material	Poles	QTY
Wafer	C3963HM-2NP/NP	Nylon66 UL94V-0	02~04	500PCS/Bag
Housing	C3963HF-2NP/NP	Nylon66 UL94V-0	02~04	500PCS/Bag
Terminal	C3963TF/TMP	Phosphor Bronze		3,500PCS/Reel

**C4140****4.14MM PITCH SERIES****SPECIFICATIONS**

- ※ Current Rating: 8A AC/DC
- ※ Voltage Rating: 300V AC/DC
- ※ Temperature Range: -25°C~+85°C
- ※ Contact Resistance: 20mΩ Max.
- ※ Insulation Resistance: 1000MΩ Min.
- ※ Withstanding Voltage: 1500V AC/minute
- ※ Wire Range: AWG#18~26

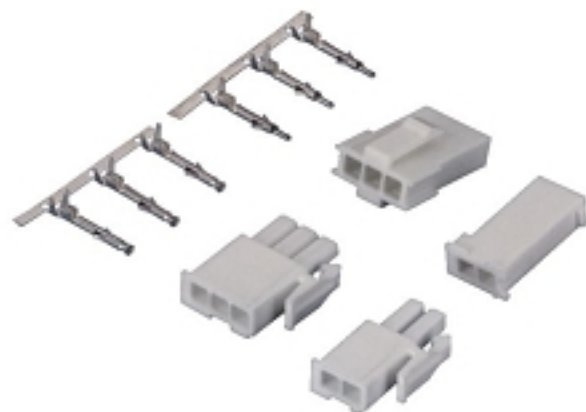

Item	Part No.	Material	Poles	QTY
Housing	C4140HF/HM-NP	Nylon66 UL94V-0	01~15	1,000PCS/Bag
Terminal	C4140TF/TMP	Phosphor Bronze		3,000PCS/Reel



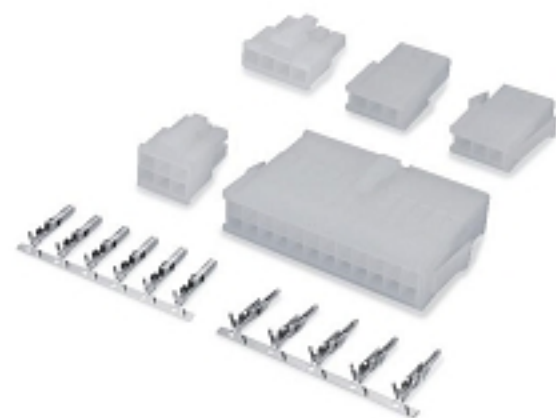

### C4255H

4.20MM PITCH SERIES

#### SPECIFICATIONS

- ※ Current Rating: 9A AC/DC
- ※ Voltage Rating: 600V AC/DC
- ※ Temperature Range: -25°C~+85°C
- ※ Contact Resistance: 10mΩ Max.
- ※ Insulation Resistance: 1000MΩ Min.
- ※ Withstanding Voltage: 1500V AC/minute
- ※ Wire Range: AWG#18~24

Item	Part No.	Material	Poles	QTY
Wafer	C4255VV(WR)X-(2)NP	Nylon66/9T UL94V-2(0)	02~24	1,000PCS/Bag
Housing	C4255HM(X)HF(X)-(2)NP	Nylon66 UL94V-2(0)	02~24	1,000PCS/Bag
Terminal	C4255TF(X)TM(X)-B/P	Brass/Phosphor Bronze		10,000PCS/Reel

### C4255W

4.20MM PITCH SERIES

#### SPECIFICATIONS

- ※ Current Rating: 9A AC/DC
- ※ Voltage Rating: 600V AC/DC
- ※ Temperature Range: -25°C~+85°C
- ※ Contact Resistance: 10mΩ Max.
- ※ Insulation Resistance: 1000MΩ Min.
- ※ Withstanding Voltage: 1500V AC/minute
- ※ Wire Range: AWG#18~24

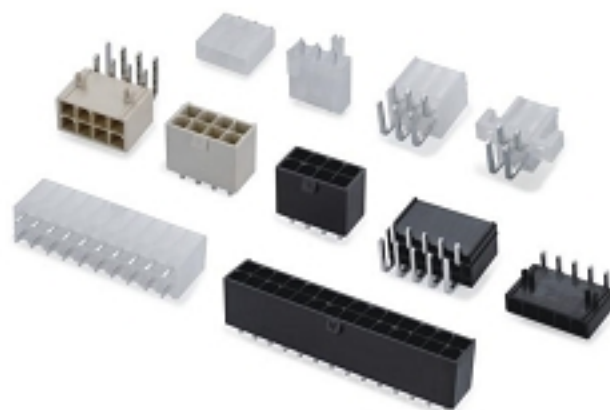

Item	Part No.	Material	Poles	QTY
Wafer	C4255VV(X)WR(X)-(2)NP	Nylon66/9T UL94V-2(0)	02~24	1,000PCS/Bag
Housing	C4255HM(X)HF(X)-(2)NP	Nylon66 UL94V-2(0)	02~24	1,000PCS/Bag
Terminal	C4255TF(X)TM(X)-B/P	Brass/Phosphor Bronze		10,000PCS/Reel

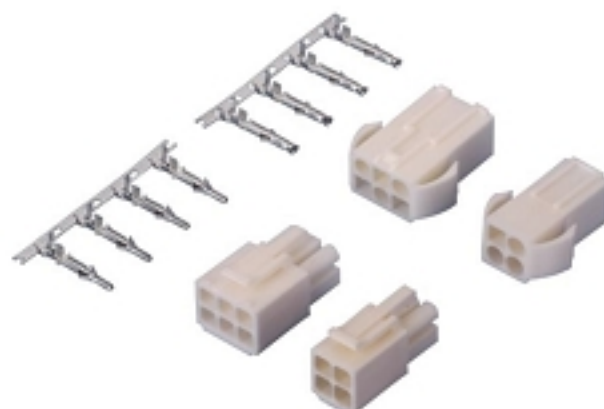

### C4500

4.50MM PITCH SERIES

#### SPECIFICATIONS

- ※ Current Rating: 10A AC/DC
- ※ Voltage Rating: 300V AC/DC
- ※ Temperature Range: -25°C~+85°C
- ※ Contact Resistance: 7mΩ Max.
- ※ Insulation Resistance: 1000MΩ Min.
- ※ Withstanding Voltage: 1500V AC/minute
- ※ Wire Range: AWG#20~26

Item	Part No.	Material	Poles	QTY
Housing	C4500HF(HM)XNP	Nylon66 UL94V-0	02~15	1,000PCS/Bag
Terminal	C4500TF/TM-B	Brass		4,000PCS/Reel

### C4501

4.50MM PITCH SERIES

#### SPECIFICATIONS

- ※ Current Rating: 10A AC/DC
- ※ Voltage Rating: 300V AC/DC
- ※ Temperature Range: -25°C~+85°C
- ※ Contact Resistance: 20mΩ Max.
- ※ Insulation Resistance: 1000MΩ Min.
- ※ Withstanding Voltage: 1500V AC/minute
- ※ Wire Range: AWG#16~24



Item	Part No.	Material	Poles	QTY
Housing	C4501HF(HM)XNP	Nylon66 UL94V-0	02~15	1,000PCS/Bag
Terminal	C4501TF/TM-B	Phosphor Bronze		4,500PCS/Reel

**C5030**

## 5.03MM PITCH SERIES

**SPECIFICATIONS**

- ※ Current Rating: 12A AC/DC
- ※ Voltage Rating: 250V AC/DC
- ※ Temperature Range: -25°C~+85°C
- ※ Contact Resistance: 10mΩ Max.
- ※ Insulation Resistance: 1000MΩ Min.
- ※ Withstanding Voltage: 1500V AC/minute
- ※ Wire Range: AWG#18~24

Item	Part No.	Material	Poles	QTY
Housing	C5030HF(A)/HM(A)-O(NP)	Nylon66 UL94V-2	01~15	1,000PCS/Bag
Terminal	C5030TF/TM-B	Brass		5,000PCS/Reel

**C5080**

## 5.08MM PITCH SERIES

**SPECIFICATIONS**

- ※ Current Rating: 10A AC/DC
- ※ Voltage Rating: 250V AC/DC
- ※ Temperature Range: -25°C~+85°C
- ※ Contact Resistance: 10mΩ Max.
- ※ Insulation Resistance: 1000MΩ Min.
- ※ Withstanding Voltage: 1500V AC/minute
- ※ Wire Range: AWG#18~24

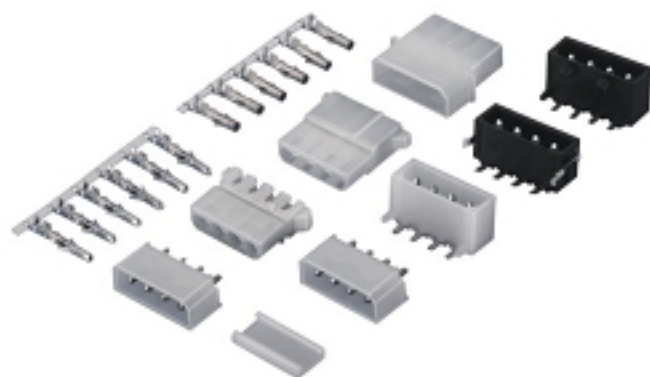

Item	Part No.	Material	Poles	QTY
Wafer	C5080WV(X)/WR(X)-O4	Nylon66 UL94V-2	04	1,000PCS/Bag
Housing	C5080HF/HM-O4	Nylon66 UL94V-2	04	1,000PCS/Bag
Terminal	C5080TF/TM-B	Brass		8,000PCS/Reel

**C5704**

## 5.70MM PITCH SERIES

**SPECIFICATIONS**

- ※ Current Rating: 12A AC/DC
- ※ Voltage Rating: 600V AC/DC
- ※ Temperature Range: -25°C~+85°C
- ※ Contact Resistance: 10mΩ Max.
- ※ Insulation Resistance: 1000MΩ Min.
- ※ Withstanding Voltage: 600V AC/minute
- ※ Wire Range: AWG#12~16

Item	Part No.	Material	Poles	QTY
Wafer	C5704WV(WR)-O2(NP)	LCP,UL94V-0	02~12	500PCS/Bag
Housing	C5704H(O2)NP	Nylon66 UL94V-0	02~12	500PCS/Bag
Terminal	C5704TF-P	Phosphor Bronze		5,000PCS/Reel

**C6200**

## 6.20MM PITCH SERIES

**SPECIFICATIONS**

- ※ Current Rating: 7A AC/DC
- ※ Voltage Rating: 250V AC/DC
- ※ Temperature Range: -25°C~+85°C
- ※ Contact Resistance: 10mΩ Max.
- ※ Insulation Resistance: 1000MΩ Min.
- ※ Withstanding Voltage: 1500V AC/minute
- ※ Wire Range: AWG#14~20

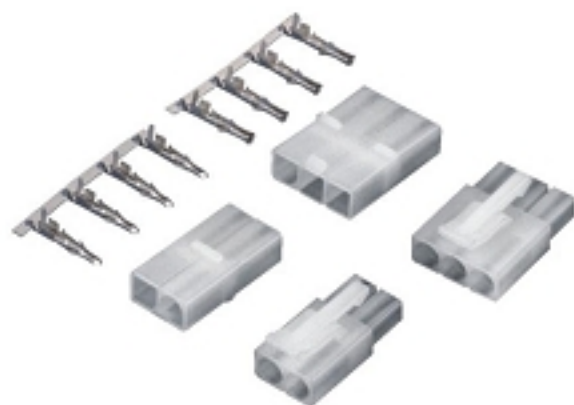

Item	Part No.	Material	Poles	QTY
Housing	C6200HM(A)/HF-NP	Nylon66 UL94V-0	02~03	1,000PCS/Bag
Terminal	C6200TM/TF-P	Phosphor Bronze		3,000PCS/Reel





### C6201

6.20MM PITCH SERIES

#### SPECIFICATIONS

- ※ Current Rating: 20A AC/DC
- ※ Voltage Rating: 600V AC/DC
- ※ Temperature Range: -25°C~+85°C
- ※ Contact Resistance: 7mΩ Max.
- ※ Insulation Resistance: 1000MΩ Min.
- ※ Withstanding Voltage: 2000V AC/minute
- ※ Wire Range: AWG#12~22

Item	Part No.	Material	Poles	QTY
Housing	C6201HF/HM-NP	Nylon66 UL94V-0	01~12	1,000PCS/Bag
Terminal	C6201TF/TM-P	Phosphor Bronze		2,000PCS/Reel

### C6350

6.35MM PITCH SERIES

#### SPECIFICATIONS

- ※ Current Rating: 15A AC/DC
- ※ Voltage Rating: 600V AC/DC
- ※ Temperature Range: -25°C~+85°C
- ※ Contact Resistance: 3.5mΩ Max.
- ※ Insulation Resistance: 1000MΩ Min.
- ※ Withstanding Voltage: 5000V AC/minute
- ※ Wire Range: AWG#14~20

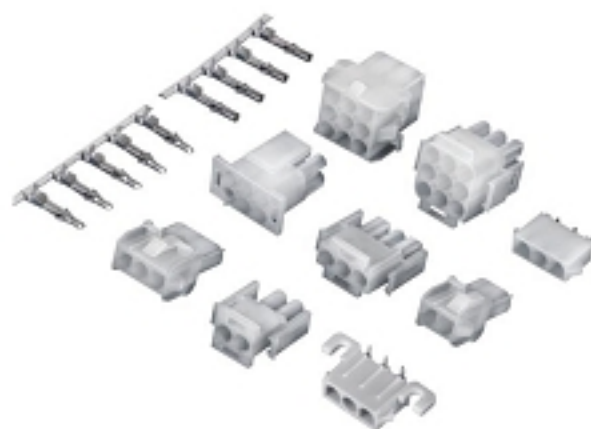

Item	Part No.	Material	Poles	QTY
Wafer	C6350WV(A)/WR(A) (X)NP	Nylon66 UL94V-0	02~15	500PCS/Bag
Housing	C6350HF/HM-DXNP	Nylon66 UL94V-0	02~15	1,000PCS/Bag
Terminal	C6350TF/TM-P	Phosphor Bronze		3,500PCS/Reel

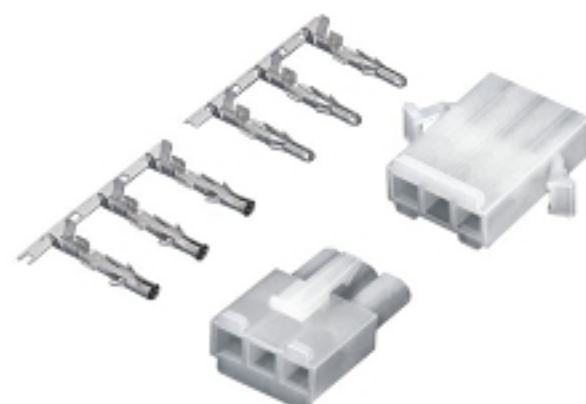

### C6700

6.70MM PITCH SERIES

#### SPECIFICATIONS

- ※ Current Rating: 12A AC/DC
- ※ Voltage Rating: 500V AC/DC
- ※ Temperature Range: -25°C~+85°C
- ※ Contact Resistance: 20mΩ Max.
- ※ Insulation Resistance: 1000MΩ Min.
- ※ Withstanding Voltage: 1500V AC/minute
- ※ Wire Range: AWG#14~20

Item	Part No.	Material	Poles	QTY
Housing	C6700HF/HM-NP	Nylon66 UL94V-2	02~15	1,000PCS/Bag
Terminal	C6700TF/TM-P	Phosphor Bronze		2,500PCS/Reel

### D1274

1.27MM PITCH MICRO MATCH SERIES

#### SPECIFICATIONS

- ※ Current Rating: 1A AC/DC
- ※ Voltage Rating: 500V AC/DC
- ※ Temperature Range: -40°C~+105°C
- ※ Contact Resistance: 20mΩ Max.
- ※ Insulation Resistance: 1000MΩ Min.
- ※ Withstanding Voltage: 500V AC/minute
- ※ Wire Range: AWG#20~24

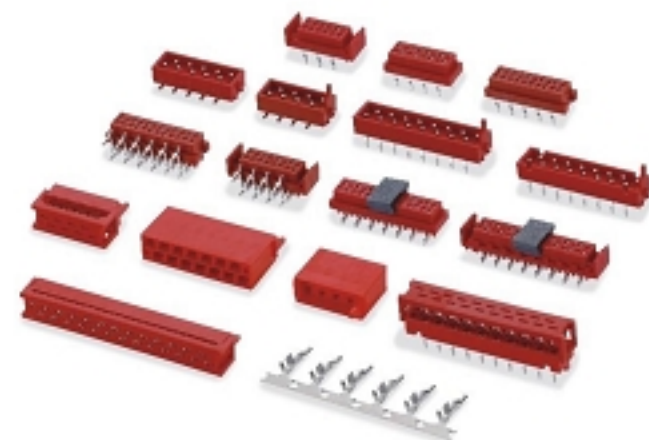

Item	Part No.	Material	Poles	QTY
Wafer	D1274WV(X)1/WV(X)S-2NP	Nylon6T/PBT UL94V-0	04~28	1,000PCS/Bag
Housing	D1274HM-2NP	PBT UL94V-0	04~28	1,000PCS/Bag
Terminal	D1274TM-P	Phosphor Bronze		10,000PCS/Reel



## D1275

### 1.27MM PITCH IDC/DIP SERIES

#### SPECIFICATIONS

- ※ Current Rating: 1A AC/DC
- ※ Voltage Rating: 250V AC/DC
- ※ Temperature Range: -25°C~+85°C
- ※ Contact Resistance: 20mΩ Max.
- ※ Insulation Resistance: 100MΩ Min.
- ※ Withstanding Voltage: 500V AC/minute

Item	Part No.	Material	Poles	QTY
Wafer	D1275WV(S)-2NP	PBT UL94V-0	04-64	1,000PCS/Bag

## D1276

### 1.27MM PITCH BOX HEADER SERIES



#### SPECIFICATIONS

- ※ Current Rating: 1A AC/DC
- ※ Voltage Rating: 250V AC/DC
- ※ Temperature Range: -25°C~+85°C
- ※ Contact Resistance: 20mΩ Max.
- ※ Insulation Resistance: 500MΩ Min.
- ※ Withstanding Voltage: 500V AC/minute

Item	Part No.	Material	Poles	QTY
Wafer	D1276WV(S)/WRD0-2NP	Nylon6T/PBT UL94V-0	04-64	1,000PCS/Bag



## D1277

### 1.27MM PITCH EJECTOR HEADER SERIES

#### SPECIFICATIONS

- ※ Current Rating: 1A AC/DC
- ※ Voltage Rating: 250V AC/DC
- ※ Temperature Range: -25°C~+85°C
- ※ Contact Resistance: 20mΩ Max.
- ※ Insulation Resistance: 500MΩ Min.
- ※ Withstanding Voltage: 500V AC/minute

Item	Part No.	Material	Poles	QTY
Wafer	D1277WV(S)/WR-2NP	Nylon6T/PBT UL94V-0	04-64	1,000PCS/Bag

## D2017

### 2.00MM PITCH EJECTOR HEADER SERIES



#### SPECIFICATIONS

- ※ Current Rating: 2A AC/DC
- ※ Voltage Rating: 250V AC/DC
- ※ Temperature Range: -25°C~+85°C
- ※ Contact Resistance: 20mΩ Max.
- ※ Insulation Resistance: 1000MΩ Min.
- ※ Withstanding Voltage: 1000V AC/minute

Item	Part No.	Material	Poles	QTY
Wafer	D2017WRA, B/WVA, B-2NP	PBT UL94V-0	06-64	1,000PCS/Bag



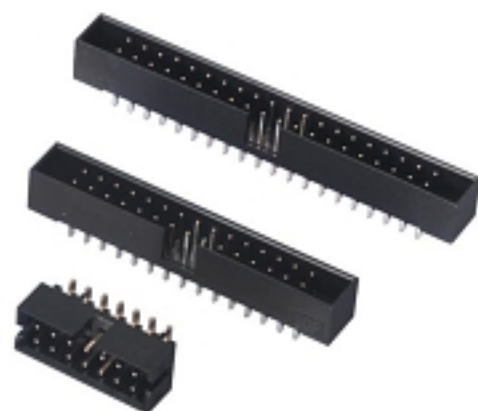

## D2018

### 2.00MM PITCH BOX HEADER SERIES

#### SPECIFICATIONS

- ※ Current Rating: 2A AC/DC
- ※ Voltage Rating: 250V AC/DC
- ※ Temperature Range: -25°C~+85°C
- ※ Contact Resistance: 20mΩ Max.
- ※ Insulation Resistance: 1000MΩ Min.
- ※ Withstanding Voltage: 1000V AC/minute

Item	Part No.	Material	Poles	QTY
Wafer	D2018WVW/SI/WR-2NP	Nylon6T UL94V-0	04-64	1,000PCS/Bag

## D2075

### 2.00MM PITCH IDC/DIP SERIES

#### SPECIFICATIONS

- ※ Current Rating: 2A AC/DC
- ※ Voltage Rating: 250V AC/DC
- ※ Temperature Range: -20°C~+85°C
- ※ Contact Resistance: 20mΩ Max.
- ※ Insulation Resistance: 1000MΩ Min.
- ※ Withstanding Voltage: 1000V AC/minute



Item	Part No.	Material	Poles	QTY
Wafer	D2075WVW/SI/2NP	PBT UL94V-0	06-64	1,000PCS/Bag



## D2553

### 2.54MM PITCH IDC/DIP SERIES

#### SPECIFICATIONS

- ※ Current Rating: 3A AC/DC
- ※ Voltage Rating: 250V AC/DC
- ※ Temperature Range: -25°C~+85°C
- ※ Contact Resistance: 20mΩ Max.
- ※ Insulation Resistance: 1000MΩ Min.
- ※ Withstanding Voltage: 1500V AC/minute

Item	Part No.	Material	Poles	QTY
Wafer	D2553WVW/SI-12NP	PBT UL94V-0	10-64	1,000PCS/Bag

## D2555

### 2.54MM PITCH BOX HEADER SERIES

#### SPECIFICATIONS

- ※ Current Rating: 3A AC/DC
- ※ Voltage Rating: 250V AC/DC
- ※ Temperature Range: -25°C~+85°C
- ※ Contact Resistance: 20mΩ Max.
- ※ Insulation Resistance: 1000MΩ Min.
- ※ Withstanding Voltage: 1500V AC/minute



Item	Part No.	Material	Poles	QTY
Wafer	D2555WVW/SI/WR-2NP	PBT/Nylon6T UL94V-0	04-64	1,000PCS/Bag



### D2558 2.54MM PITCH SERIES

#### SPECIFICATIONS

- ※ Current Rating: 1.2A AC/DC
- ※ Voltage Rating: 250V AC/DC
- ※ Temperature Range: -25°C~+85°C
- ※ Contact Resistance: 15mΩ Max.
- ※ Insulation Resistance: 1000MΩ Min.
- ※ Withstanding Voltage: 750V AC/minute

Item	Part No.	Material	Poles	QTY
Wafer	D2558WA/WX/S-NP	Nylon6T UL94V-0	04-26	1,000PCS/Bag
Housing	D2558HD/2-NP	PBT UL94V-0	04-26	1,000PCS/Bag

### D2559 2.54MM PITCH IDC SERIES

#### SPECIFICATIONS

- ※ Current Rating: 3A AC/DC
- ※ Voltage Rating: 250V AC/DC
- ※ Temperature Range: -40°C~+105°C
- ※ Contact Resistance: 10mΩ Max.
- ※ Insulation Resistance: 1000MΩ Min.
- ※ Withstanding Voltage: 1500V AC/minute
- ※ Wire Range: AWG#22~28

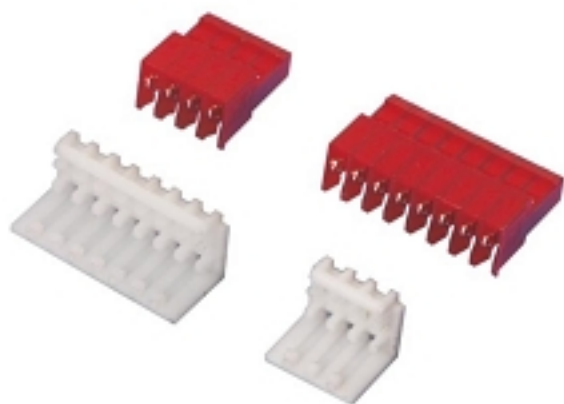

Item	Part No.	Material	Poles	QTY
Housing	D2559H/A/B/NP	Nylon66 UL94V-2	02-24	1,000PCS/Bag



### D3964 3.96MM PITCH IDC SERIES

#### SPECIFICATIONS

- ※ Current Rating: 7A AC/DC
- ※ Voltage Rating: 250V AC/DC
- ※ Temperature Range: -40°C~+105°C
- ※ Contact Resistance: 10mΩ Max.
- ※ Insulation Resistance: 1000MΩ Min.
- ※ Withstanding Voltage: 1500V AC/minute
- ※ Wire Range: AWG#18~26

Item	Part No.	Material	Poles	QTY
Housing	D3964H/A/B/NP	Nylon66 UL94V-2	02-18	1,000PCS/Bag

### F0300 0.30MM PITCH FPC/FFC SERIES

#### SPECIFICATIONS

- ※ Current Rating: 0.2A AC/DC
- ※ Voltage Rating: 30V AC/DC
- ※ Temperature Range: -25°C~+85°C
- ※ Contact Resistance: 30mΩ Max.
- ※ Insulation Resistance: 100MΩ Min.
- ※ Withstanding Voltage: 250V AC/minute
- ※ Wire Range: 250V AC/minute

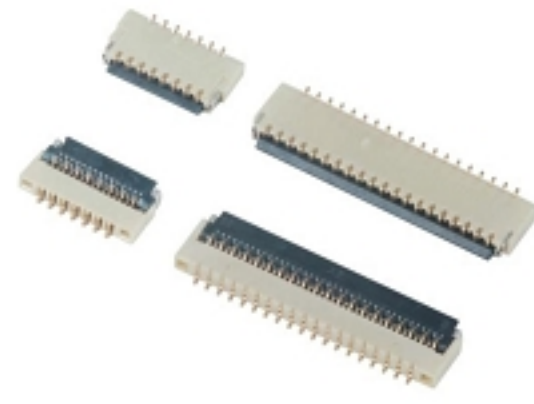

Item	Part No.	Material	Poles	QTY
Wafer	F0300WRAS-NP	LCFNylon6T UL94V-0	13-71	2,500PCS/Reel



**F0504WRA/B**

0.50MM PITCH FPC/FFC SERIES

**SPECIFICATIONS**

- ※ Current Rating: 0.5A AC/DC
- ※ Voltage Rating: 50V AC/DC
- ※ Temperature Range: -25°C~+85°C
- ※ Contact Resistance: 30mΩ Max.
- ※ Insulation Resistance: 100MΩ Min.
- ※ Withstanding Voltage: 150V AC/minute

Item	Part No.	Material	Poles	QTY
Wafer	F0504WR(X)S-NP	LCP/Nylon6T UL94V-0	04-60	4,000PCS/Reel

**F1003**

1.00MM PITCH FPC/FFC SERIES

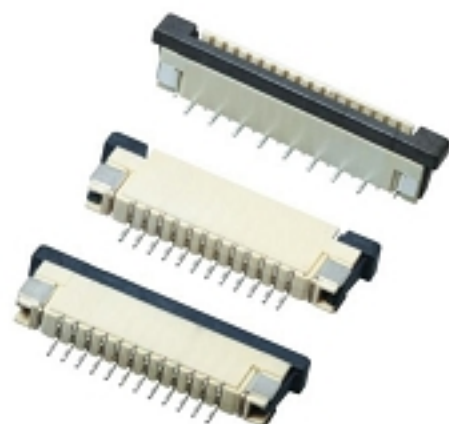
**SPECIFICATIONS**

- ※ Current Rating: 0.5A AC/DC
- ※ Voltage Rating: 50V AC/DC
- ※ Temperature Range: -25°C~+85°C
- ※ Contact Resistance: 30mΩ Max.
- ※ Insulation Resistance: 500MΩ Min.
- ※ Withstanding Voltage: 500V AC/minute

Item	Part No.	Material	Poles	QTY
Wafer	F1003WV(S)RS-NP	Nylon6T/LCP UL94V-0	04-40	800PCS/Reel

**PH080**

0.80MM PITCH PIN HEADER

**SPECIFICATIONS**

- ※ Current Rating: 0.75A AC/DC
- ※ Voltage Rating: 500V AC/DC
- ※ Temperature Range: -25°C~+85°C
- ※ Contact Resistance: 30mΩ Max.
- ※ Insulation Resistance: 1000MΩ Min.
- ※ Withstanding Voltage: 500V AC/minute
- ※ Wire Range: /

Item	Part No.	Material	Poles	QTY
Wafer	PH080V(X)S/R(X)S-NP	Nylon6T UL94V-0	02-20	1,000PCS/Bag
Wafer	PH080V(X)S/R(X)S-2NP	Nylon6T UL94V-0	04-40	1,000PCS/Bag

**PH100**

1.00MM PITCH PIN HEADER

**SPECIFICATIONS**

- ※ Current Rating: 1A AC/DC
- ※ Voltage Rating: 500V AC/DC
- ※ Temperature Range: -25°C~+85°C
- ※ Contact Resistance: 30mΩ Max.
- ※ Insulation Resistance: 1000MΩ Min.
- ※ Withstanding Voltage: 500V AC/minute
- ※ Wire Range: /

Item	Part No.	Material	Poles	QTY
Wafer	PH100V(X)S/R(X)S-NP	Nylon6T UL94V-0	02-20	1,000PCS/Bag
Wafer	PH100V(X)S/R(X)S-2NP	Nylon6T UL94V-0	04-40	1,000PCS/Bag



### FH127

1.27MM PITCH FEMALE  
HEADER SERIES

#### SPECIFICATIONS

- ※ Current Rating: 1A AC/DC
- ※ Voltage Rating: 250V AC/DC
- ※ Temperature Range: -25°C~+85°C
- ※ Contact Resistance: 20mΩ Max.
- ※ Insulation Resistance: 500MΩ Min.
- ※ Withstanding Voltage: 500V AC/minute

Item	Part No.	Material	Poles	QTY
Wafer	FH127V(X)S/RX(S)-NP	Nylon6T UL94V-0	06-40	1,000PCS/Bag
Wafer	FH127V(X)S/RX(S)-2NP	Nylon6T UL94V-0	08-80	1,000PCS/Bag

### PH127

1.27MM PITCH PIN  
HEADER SERIES

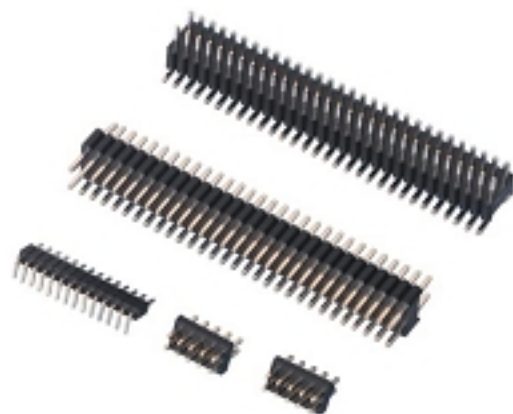

#### SPECIFICATIONS

- ※ Current Rating: 1A AC/DC
- ※ Voltage Rating: 250V AC/DC
- ※ Temperature Range: -25°C~+85°C
- ※ Contact Resistance: 20mΩ Max.
- ※ Insulation Resistance: 500MΩ Min.
- ※ Withstanding Voltage: 500V AC/minute

Item	Part No.	Material	Poles	QTY
Wafer	PH127V(X)S/RX(S)-NP	Nylon6T UL94V-0	06-40	1,000PCS/Bag
Wafer	PH127V(X)S/RX(S)-2NP	Nylon6T UL94V-0	08-80	1,000PCS/Bag

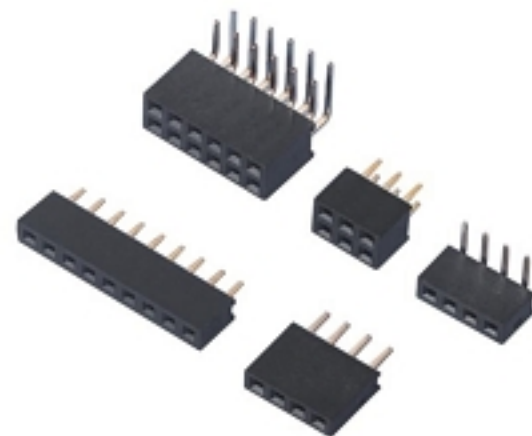

### FH200

2.00MM PITCH FEMALE  
HEADER SERIES

#### SPECIFICATIONS

- ※ Current Rating: 2A AC/DC
- ※ Voltage Rating: 250V AC/DC
- ※ Temperature Range: -25°C~+85°C
- ※ Contact Resistance: 20mΩ Max.
- ※ Insulation Resistance: 1000MΩ Min.
- ※ Withstanding Voltage: 1000V AC/minute

Item	Part No.	Material	Poles	QTY
Wafer	FH200V(X)S/RX(S)-NP	Nylon6T UL94V-0	02-40	1,000PCS/Bag
Wafer	FH200V(X)S/RX(S)-2NP	Nylon6T UL94V-0	02-80	1,000PCS/Bag

### PH200

2.00MM PITCH PIN  
HEADER SERIES



#### SPECIFICATIONS

- ※ Current Rating: 2A AC/DC
- ※ Voltage Rating: 250V AC/DC
- ※ Temperature Range: -25°C~+85°C
- ※ Contact Resistance: 20mΩ Max.
- ※ Insulation Resistance: 1000MΩ Min.
- ※ Withstanding Voltage: 1000V AC/minute

Item	Part No.	Material	Poles	QTY
Wafer	PH200V(X)S/RX(S)-NP	Nylon6T UL94V-0	02-40	1,000PCS/Bag
Wafer	PH200V(X)S/RX(S)-2NP	Nylon6T UL94V-0	02-80	1,000PCS/Bag



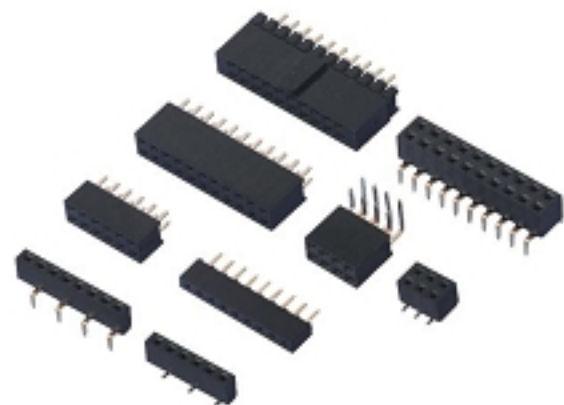

### FH254 2.54MM PITCH FEMALE HEADER SERIES

#### SPECIFICATIONS

- ※ Current Rating: 3A AC/DC
- ※ Voltage Rating: 250V AC/DC
- ※ Temperature Range: -25°C~+85°C
- ※ Contact Resistance: 20mΩ Max.
- ※ Insulation Resistance: 1000MΩ Min.
- ※ Withstanding Voltage: 1500V AC/minute

Item	Part No.	Material	Poles	QTY
Wafer	FH254V(X)S(RX)SI-NP	PBT/Nylon6T UL94V0	02-40	1,000PCS/Bag
Wafer	FH254V(X)S(RX)SI-2NP	PBT/Nylon6T UL94V0	02-80	1,000PCS/Bag

### PH254 2.54MM PITCH PIN HEADER SERIES

#### SPECIFICATIONS

- ※ Current Rating: 3A AC/DC
- ※ Voltage Rating: 250V AC/DC
- ※ Temperature Range: -40°C~+105°C
- ※ Contact Resistance: 20mΩ Max.
- ※ Insulation Resistance: 1000MΩ Min.
- ※ Withstanding Voltage: 1000V AC/minute

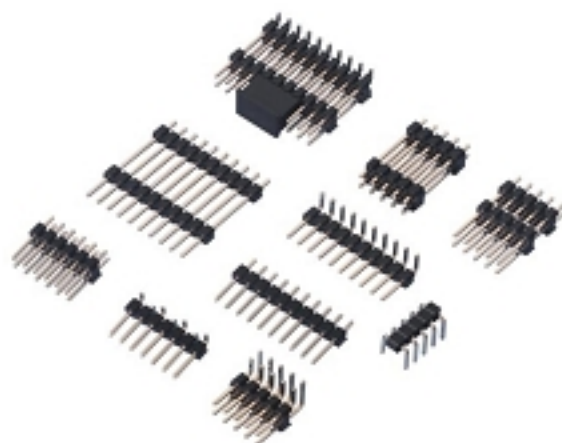

Item	Part No.	Material	Poles	QTY
Wafer	PH254V(X)S(RX)SI-NP	PBT/Nylon6T UL94V0	01-40	1,000PCS/Bag
Wafer	PH254V(X)S(RX)SI-2NP	PBT/Nylon6T UL94V0	02-80	1,000PCS/Bag



### PH300 3.00MM PITCH PIN HEADER

#### SPECIFICATIONS

- ※ Current Rating: 5A AC/DC
- ※ Voltage Rating: 250V AC/DC
- ※ Temperature Range: -25°C~+85°C
- ※ Contact Resistance: 10mΩ Max.
- ※ Insulation Resistance: 1000MΩ Min.
- ※ Withstanding Voltage: 1500V AC/minute
- ※ Wire Range: /

Item	Part No.	Material	Poles	QTY
Wafer	PH300V-2NP	Nylon6T UL94V0	02-30	1,000PCS/Bag

### PH420 4.20MM PITCH PIN HEADER

#### SPECIFICATIONS

- ※ Current Rating: 9A AC/DC
- ※ Voltage Rating: 600V AC/DC
- ※ Temperature Range: -25°C~+85°C
- ※ Contact Resistance: 10mΩ Max.
- ※ Insulation Resistance: 1000MΩ Min.
- ※ Withstanding Voltage: 1500V AC/minute
- ※ Wire Range: /



Item	Part No.	Material	Poles	QTY
Wafer	PH420V-2NP	Nylon6T UL94V0	02-30	1,000PCS/Bag

**Q-TB****TERMINAL BLOCK SERIES****SPECIFICATIONS**

- ※ Current Rating: 5A-30A AC/DC
- ※ Voltage Rating: 250V/300V AC/DC
- ※ Temperature Range: -40°C~+105°C
- ※ Contact Resistance: 20mΩ Max.
- ※ Insulation Resistance: 5000MΩ Min.
- ※ Withstanding Voltage: 2000V AC/minute
- ※ Wire Range: AWG#12~26

Item	Part No.	Material	Poles	QTY
TB	TB3810VA/VB-2NP	Nylon66 UL94V-0	02-24	1,000PCS/Bag
TB	TB5000VA/VA-R-NP	Nylon66 UL94V-0	02-24	1,000PCS/Bag
TB	TB5000VA/VA-R-NP	Nylon66 UL94V-0	02-24	1,000PCS/Bag
TB	TB7500VA/VA-R-NP	Nylon66 UL94V-0	02-24	1,000PCS/Bag
TB	TB5001VA/VA-NP	Nylon66 UL94V-0	02-24	1,000PCS/Bag

**Q-DIN****DIN41612 SERIES****SPECIFICATIONS**

- ※ Current Rating: 1.5A AC/DC
- ※ Voltage Rating: 250V AC/DC
- ※ Temperature Range: -25°C~+85°C
- ※ Contact Resistance: 20mΩ Max.
- ※ Insulation Resistance: 1000MΩ Min.
- ※ Withstanding Voltage: 1000V AC/minute



Item	Part No.	Material	Poles	QTY
DIN41612	DINVD0/RD0-XNP	PBT UL94V-0	16-320	Tray

