

High-Power & Low-Voltage Stereo Audio Power Amplifier with Electronic Volume

■ GENERAL DESCRIPTION

The **NJU7086** is a stereo audio power amplifier designed for portable applications. Three input selector and an electronic volume are built into, and it contributes to a reduction of the number of external parts. No external coupling capacitors are required because of the differential outputs. The closed loop gain is adjusted by two external resistors. And the standby mode control reduces the supply current.

The **NJU7086** contains pop & click noise protection circuitry which eliminates noises during turn-on and turn-off transitions and RF rectification canceling circuitry.

■ PACKAGE OUTLINE



NJU7086

■ APPLICATION

- Portable DVD/TV
- Portable Navigation
- PC Monitor

■ FEATURES

- Operating Voltage $V^+ = 2.8$ to $5.5V$
- Three Input Selector
- Electronic Volume 0dB ~ -64dB
- Operating Current $I_{DD1} = 8$ mA typ. ($V^+ = 5V, BTL$ mode, $R_L = \infty$, No Signal)
- Supply Current in Power Down Mode $I_{DD4} = 5\mu A$ max. (STBY mode)
- Output Power $P_o = 1W/ch$ typ. ($V^+ = 5V, R_L = 8\Omega, THD = 2\%$)
- Standby function
- Mute Function
- Headphone detecting function
- Switch function of Differential output and Single ended output
- C-MOS Technology
- Package Outline LQFP48

■ BLOCK DIAGRAM

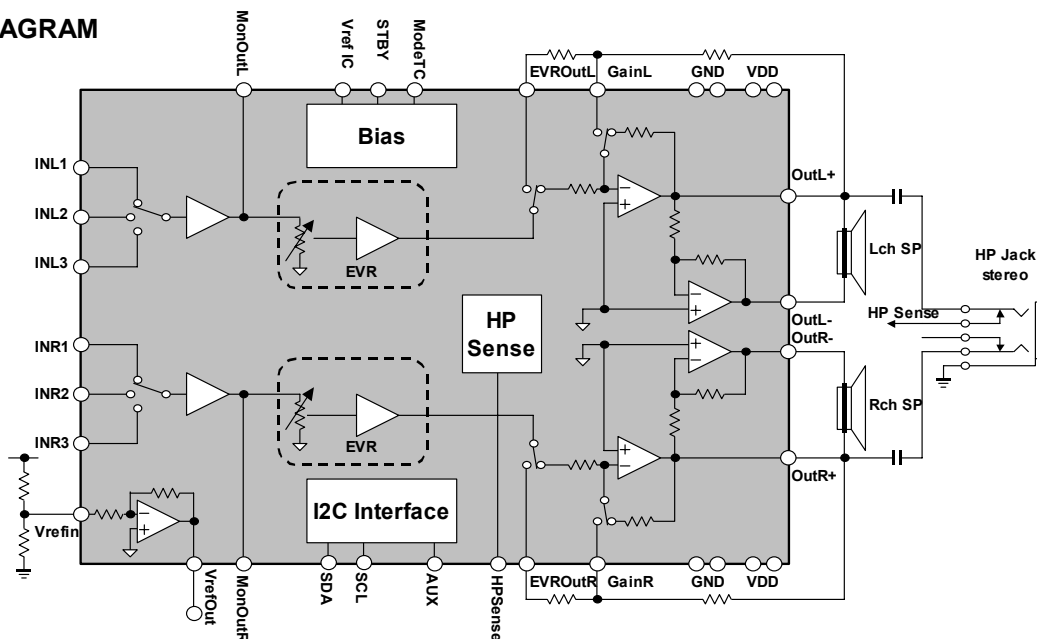

NJU7086

■ PIN CONFIGURATION (LQFP48)

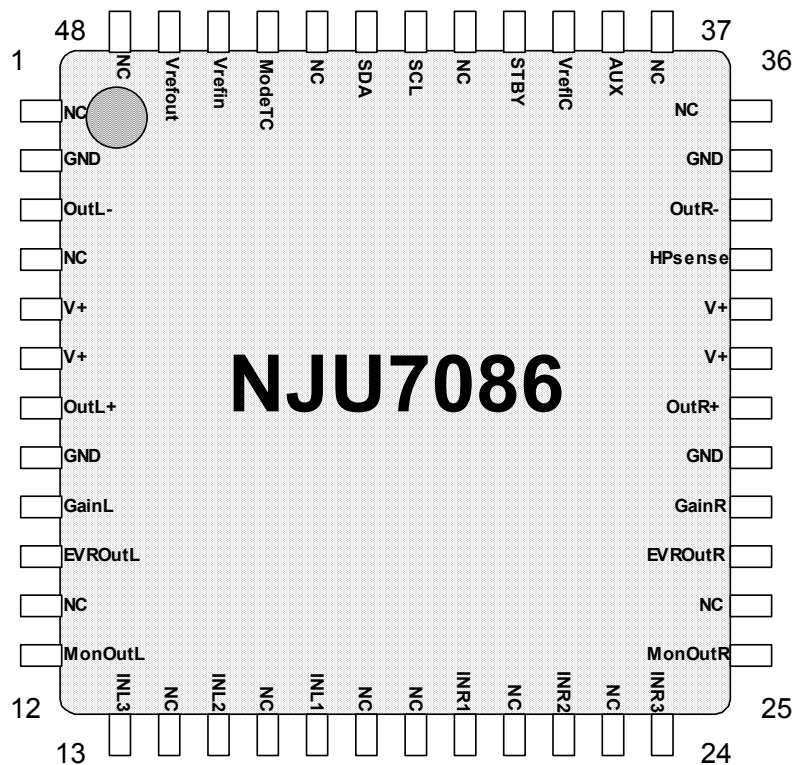

No.	Symbol	Function	No.	Symbol	Function
1	NC	-	25	MonOutR	Rch Monitor Output
2	GND	GND	26	NC	-
3	OutL-	Lch- Output	27	EVROutR	Rch Electronic Volume Output
4	NC	-	28	GND	GND
5	V ⁺	Power Supply	29	GND	GND
6	V ⁺	Power Supply	30	OutR+	Rch+ Output
7	OutL+	Lch+ Output	31	V ⁺	Power Supply
8	GND	GND	32	V ⁺	Power Supply
9	GainL	Lch External gain setting resistance connection	33	HPsense	Headphone Detecting
10	EVROutL	Lch Electronic Volume Output	34	OutR-	Rch- Output
11	NC	-	35	GND	GND
12	MonOutL	Lch Monitor Output	36	NC	-
13	INL3	Lch Input 3	37	NC	-
14	NC	-	38	AUX	Auxiliary Output
15	INL2	Lch Input 2	39	VrefIC	Reference Voltage for Internal Circuit
16	NC	-	40	STBY	Standby Setting
17	INL1	Lch Input 1	41	NC	-
18	NC	-	42	SCL	I ² C DATA Input
19	NC	-	43	SDA	I ² C Clock Input
20	INR1	Rch Input 1	44	NC	-
21	NC	-	45	ModeTC	Mode Switching-noise Rejection Capacitor
22	INR2	Rch Input 2	46	Vrefin	Reference Voltage Input for External Circuit
23	NC	-	47	Vrefout	Reference Voltage Output for External Circuit
24	INR3	Rch Input 3	48	NC	-

*All power supply pin should be connected.

■ ABSOLUTE MAXIMUM RATINGS (Ta=25°C)

PARAMETER	SYMBOL	RATINGS	UNIT
Supply Voltage	V ⁺	+7	V
Maximum Input Voltage	V _{IN}	-0.3V to V ⁺ +0.3V	V
Power Dissipation	P _D	1660 ^{*1)} 2500 ^{*2)}	mW
Output Peak Current	I _o	550	mA
Operating Temperature Range	T _{opr}	-40 to +85	°C
Storage Temperature Range	T _{stg}	-40 to +150	°C

*1) EIA/JEDEC STANDARD Test board (76.2 x 114.3 x 1.6mm, 2layers, FR-4) mounting

*2) EIA/JEDEC STANDARD Test board (76.2 x 114.3 x 1.6mm, 4layers, FR-4) mounting

Junction Temperature:

T_j = θ_{ja} (Thermal Resistance) x P_d (Power Dissipation on your application) x T_a (Ambient Temperature)

T_j should be less than 0.8 times of the storage maximum temperature.

■ RECOMMENDED OPERATING VOLTAGE RANGE (Ta=25°C)

PARAMETER	SYMBOL	TEST CONDITION	MIN.	TYP.	MAX.	UNIT
Operating Voltage Range	V ⁺	-	2.8	5.0	5.5	V

■ ELECTRICAL CHARACTERISTICS (Ta=25°C, V⁺=5V, Unless otherwise specified)

PARAMETER	SYMBOL	TEST CONDITION	MIN.	TYP.	MAX.	UNIT
Operating Current	I _{DD1}	No signal, R _L =∞, Active/BTL mode	-	8.0	15.0	mA
	I _{DD2}	No signal, R _L =∞, Active/SE mode	-	5.5	12.0	mA
	I _{DD3}	No signal, R _L =∞, Charge mode STBY=HPsense=0V	-	200	400	μA
	I _{DD4}	No signal, R _L =∞, STBY mode STBY=HPsense=0V	-	-	5.0	μA
Reference Voltage 1	V _{REF}	VrefIC	2.25	2.5	2.75	V
Reference Voltage 2	V _{REFOUT}	Vrefout, Vrefin= V _{REF} - 0.2V	2.80	3.10	3.30	V

● AC Characteristics

Common Characteristics

(Ta=25°C, V⁺=5V, vol=0dB, Gv=0dB, V_{IN}=-20dBV, f=1kHz, R_L=32Ω, SE mode, unless otherwise specified)

PARAMETER	SYMBOL	TEST CONDITION	MIN.	TYP.	MAX.	UNIT
Input Resistance	R _{IN}	INL1~3, INR1~3	-	50	-	kΩ
Mute Attenuation 1	G _{VMIN1}	Vol=Mute, mode=Active, Vin=1Vrms	-80	-	-	dB
Mute Attenuation 2	G _{VMIN2}	Vol=0dB, mode=Mute, Vin=1Vrms	-75	-	-	dB
Cross Talk	CT	Vin=1Vrms	-	70	-	dB
Monitor Output Gain	G _{VMON}	Vin=1Vrms	-1.0	0.0	+1.0	dB
Power Supply Rejection Ratio	Vripple	Vripple=1kHz / 100mVrms	-	55	-	dB

● AC Characteristics

Single Ended Operation(SE mode)

(Ta=25°C, V⁺=5V, vol=0dB, Gv=6dB, V_{IN}=-20dBV, f=1kHz, R_L=32Ω, BTL mode, unless otherwise specified)

PARAMETER	SYMBOL	TEST CONDITION	MIN.	TYP.	MAX.	UNIT
Maximum Gain	G _{VMAX1}	Vol=0dB	-1.5	0.0	+1.5	dB
Output Power	P _{O1}	THD=2%, f=1kHz	-	90	-	mW
Total Harmonic Distortion	THD ₁	P _{O1} =10mW, BW=400Hz to 30kHz	-	0.03	0.3	%
Output Noise Voltage	V _{NO1}	Rg=0Ω, Filter = A-weighted	-	-95 (18)	-	dBV (μV)
Channel Separation	CS ₁	f=1kHz, Vo=1Vrms, Rg=600Ω	-	70	-	dB

● AC Characteristics

Differential Operation(BTL mode)

NJU7086

(Ta=25°C, V⁺=5V, vol=0dB, Gv=6dB, V_{IN}=-20dBV, f=1kHz, R_L=8Ω, BTL mode, unless otherwise specified)

PARAMETER	SYMBOL	TEST CONDITION	MIN.	TYP.	MAX.	UNIT
Maximum Gain	G _{VMAX2}	Vol=0dB	4.5	6.0	7.5	dB
Output Power	P _{O2}	THD=2%, f=1kHz	-	1.0	-	W
Total Harmonic Distortion	THD ₂	P _{O2} =400mW, BW=400Hz to 30kHz	-	0.1	1.0	%
Output Noise Voltage	V _{NO2}	Rg=0Ω, Filter = A-weighted	-	-89 (36)	-	dBV (μV)
Channel Separation	CS ₂	f=1kHz, Vo=1Vrms, Rg=600Ω	-	65	-	dB
Output Offset Voltage	V _{OD}	No Signal	-100	-	100	mV

• **Mode Control** (Ta=25°C, V⁺=5V)

PARAMETER	SYMBOL	TEST CONDITION	MIN.	TYP.	MAX.	UNIT
HP sense terminal High Level Input Voltage	V _{IHHP}		0.7V ⁺	-	V ⁺	V
HP sense terminal Low Level Input Voltage	V _{ILHP}		0	-	0.3V ⁺	V
STBY terminal Low Level Input Voltage	V _{IHSTBY}		0.7V ⁺	-	V ⁺	V
STBY terminal Low Level Input Voltage	V _{ILSTBY}		0	-	0.3V ⁺	V
AUX High Level Output Voltage	V _{AUXH}	AUX Output=High Pull-up Resistance=3.9kΩ	V _{pullup} -0.5	-	V _{pullup}	V
AUX Low Level Output Voltage	V _{AUXL}	AUX Output=Low Pull-up Resistance=3.9kΩ	0	-	0.5	V

V_{pullup} : External Pull-up Voltage=5.5V(max)

TEST CIRCUIT

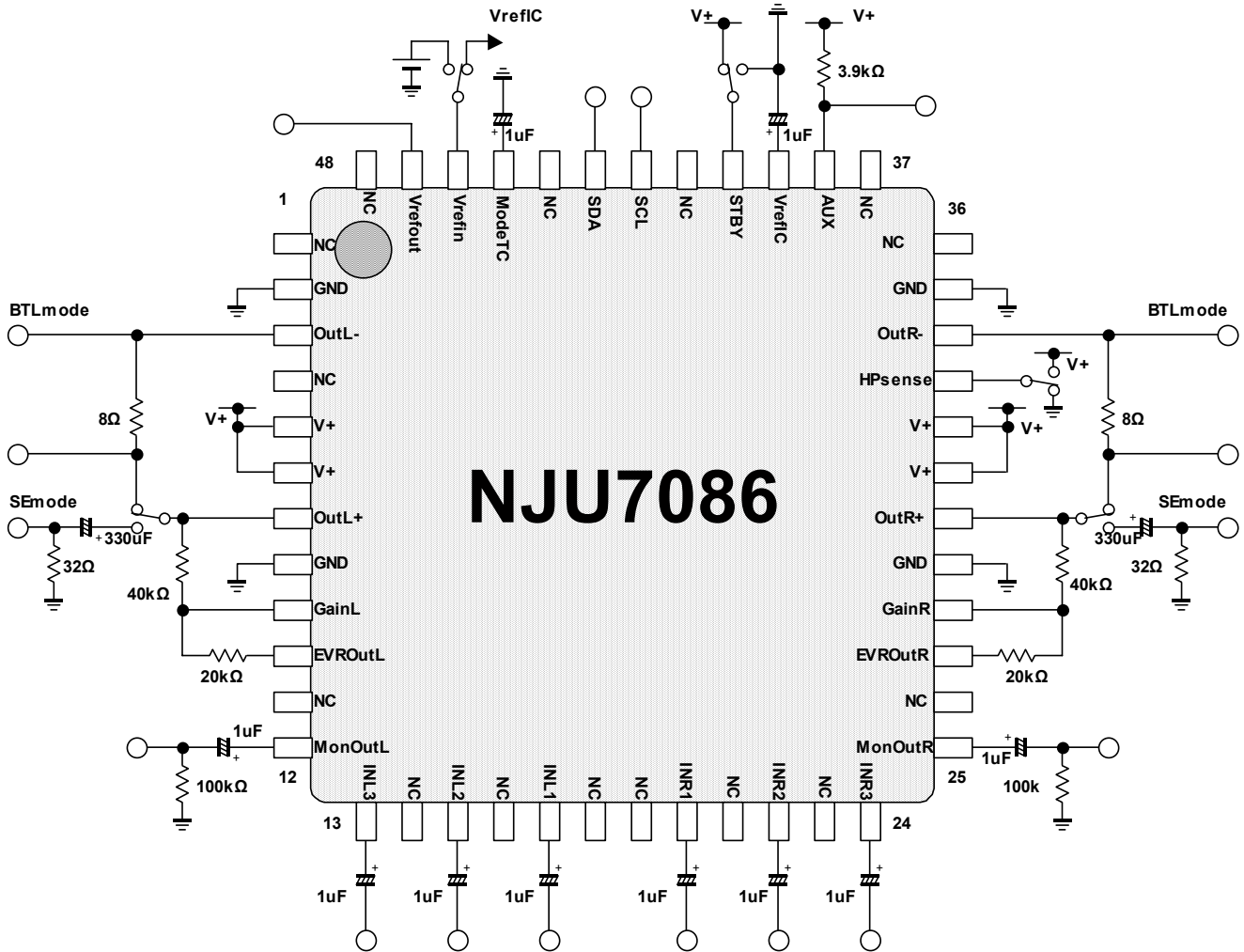

<Reference Voltage for External Circuit>

Output voltage (Vrefout) is calculated from the next expression.

$$V_{refout} = 2V^+ - 3V^+ \left(\frac{(10k\Omega + R_1/2) \times 10k\Omega}{(R_1 + R_2) \times 10k\Omega + R_1 \times R_2} \right)$$

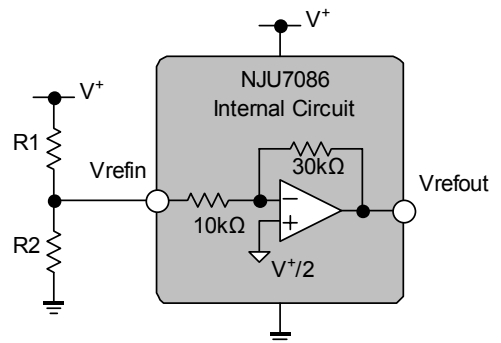

NJU7086

APPLICATION CIRCUIT

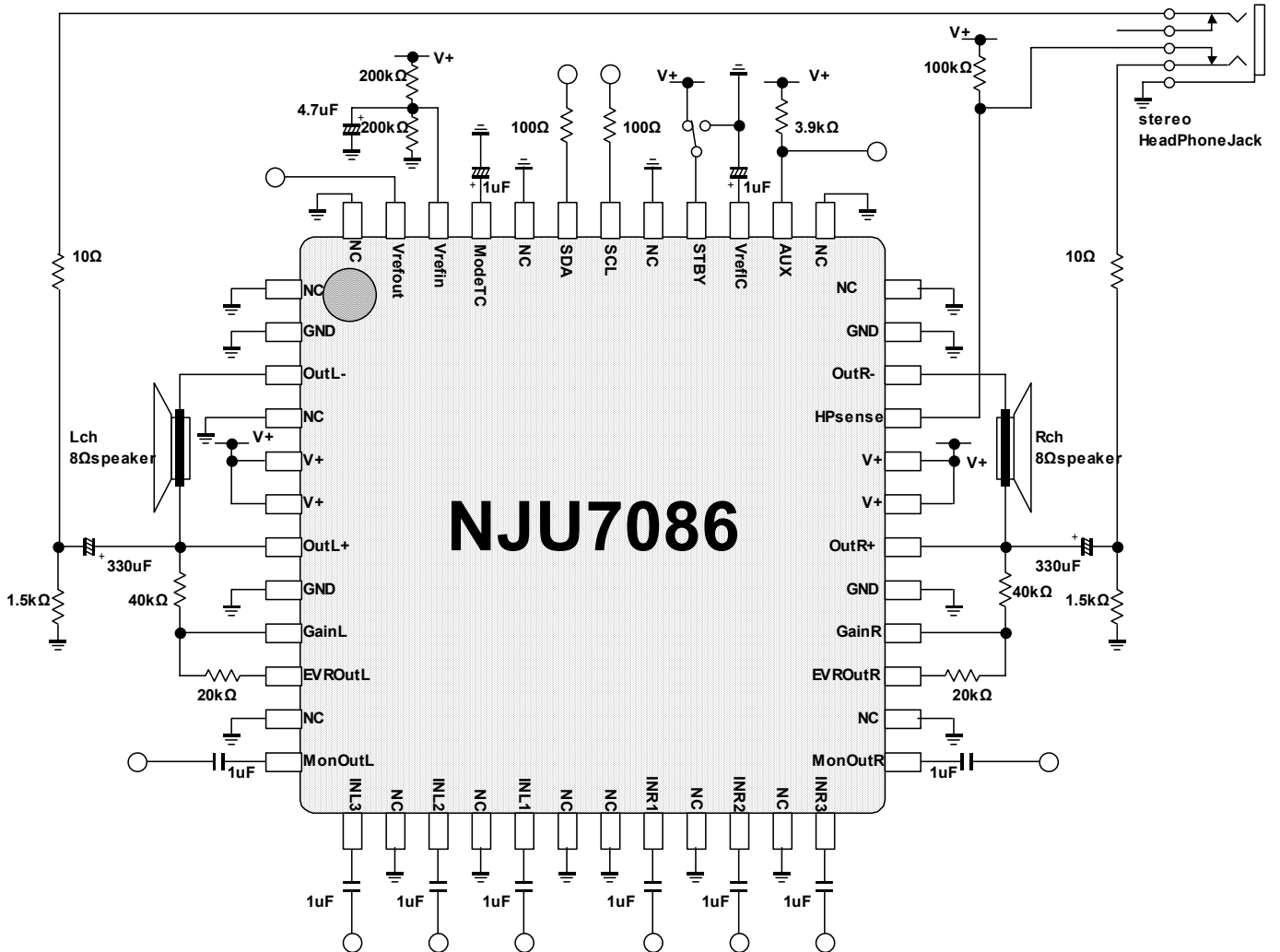

■TIMING ON THE I²C BUS (SDA,SCL)

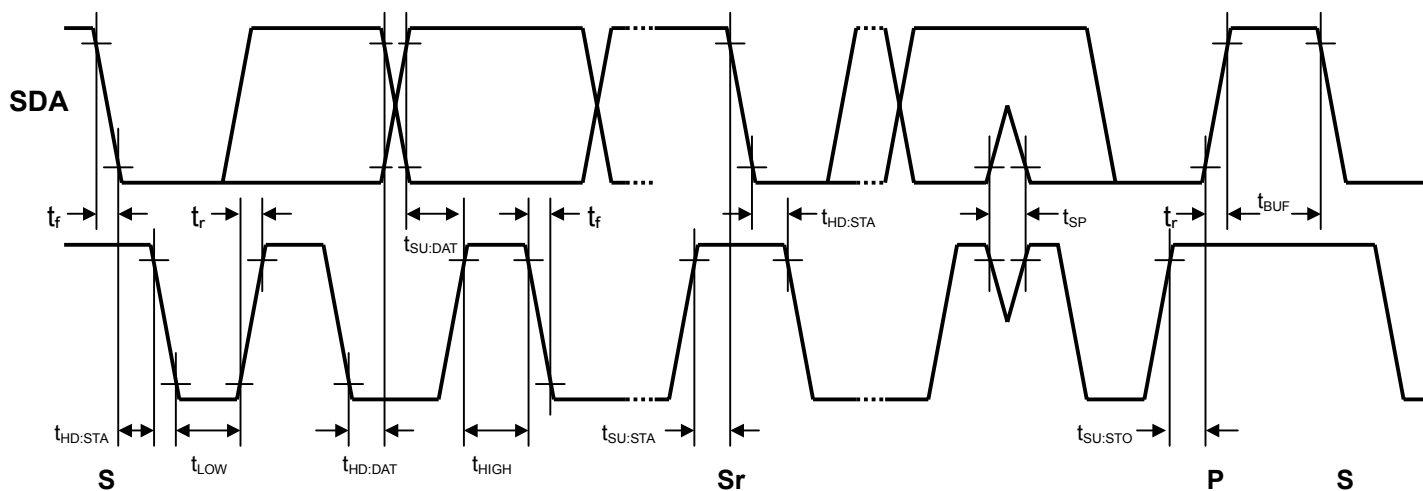

■CHARACTERISTICS OF I/O STAGES FOR I²C BUS (SDA,SCL)

I²C BUS Load Conditions

STANDARD MODE : Pull up resistance 4k Ω (Connected to +5V), Load capacitance 200pF (Connected to GND)

FAST MODE : Pull up resistance 4k Ω (Connected to +5V), Load capacitance 50pF (Connected to GND)

PARAMETER	SYMBOL	Standard mode			Fast mode			UNIT
		MIN.	TYP.	MAX.	MIN.	TYP.	MAX.	
Low Level Input Voltage	V_{IL}	0.0	-	0.25V ⁺	0.0	-	0.25V ⁺	V
High Level Input Voltage	V_{IH}	0.75V ⁺		V ⁺	0.75V ⁺		V ⁺	V
Low level output voltage (3mA at SDA pin)	V_{OL}	0	-	0.4	0	-	0.4	V
Input current each I/O pin with an input voltage between 0.1V _{DD} and 0.9V _{DDmax}	I_i	-10	-	10	-10	-	10	μ A

■ CHARACTERISTICS OF BUS LINES (SDA,SCL) FOR I²C-BUS DEVICES

PARAMETER	SYMBOL	Standard mode			Fast mode			UNIT
		MIN.	TYP.	MAX.	MIN.	TYP.	MAX.	
SCL clock frequency	f _{SCL}	-	-	100	-	-	400	kHz
Hold time (repeated) START condition.	t _{HD:STA}	4.0	-	-	0.6	-	-	μs
Low period of the SCL clock	t _{LOW}	4.7	-	-	1.3	-	-	μs
High period of the SCL clock	t _{HIGH}	4.0	-	-	0.6	-	-	μs
Set-up time for a repeated START condition	t _{SU:STA}	4.7	-	-	0.6	-	-	μs
Data hold time ^(NOTE)	t _{HD:DAT}	0	-	-	0	-	-	μs
Data set-up time	t _{SU:DAT}	250	-	-	100	-	-	ns
Rise time of both SDA and SCL signals	t _r	-	-	1000	-	-	300	ns
Fall time of both SDA and SCL signals	t _f	-	-	300	-	-	300	ns
Set-up time for STOP condition	t _{SU:STO}	4.0	-	-	0.6	-	-	μs
Bus free time between a STOP and START condition	t _{BUF}	4.7	-	-	1.3	-	-	μs
Capacitive load for each bus line	C _b	-	-	400	-	-	400	pF
Noise margin at the Low level	V _{nL}	0.5	-	-	0.5	-	-	V
Noise margin at the High level	V _{nH}	1	-	-	1	-	-	V

C_b ; total capacitance of one bus line in pF.

NOTE). Data hold time : t_{HD:DAT}

Please hold the Data Hold Time (t_{HD:DAT}) to 300ns or more to avoid status of unstable at SCL falling edge.

■ DEFINITION OF I²C REGISTER

• I²C BUS FORMAT

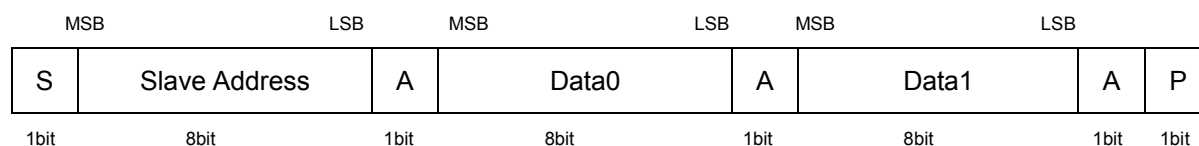

S: Starting Term

A: Acknowledge Bit

P: Ending Term

• SLAVE ADDRESS

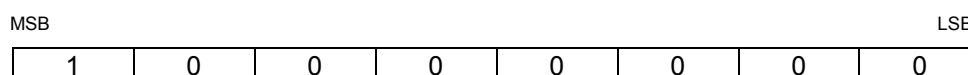

• CONTROL REGISTER TABLE

Data0								Data1									
D7	D6	D5	D4	D3	D2	D1	D0	D7	D6	D5	D4	D3	D2	D1	D0		
Don't Care		InputSel		HP	GainSel	AUX		Mode		Don't Care				Volume			

• CONTROL REGISTER DEFAULT VALUE

Control register default value is all "0".

Data0								Data1							
D7	D6	D5	D4	D3	D2	D1	D0	D7	D6	D5	D4	D3	D2	D1	D0
-	0	0	0	0	0	0	0	-	-	-	0	0	0	0	0

■ INSTRUCTION CODE

InputSel(Ch1~3 select)

InputSel	Data0		Note
	D6	D5	
Ch1*	0	0	Ch1 select
Ch2	0	1	Ch2 select
Ch3	1	0	Ch3 select
Ch3	1	1	Ch3 select

*Default Value

HP(Output operating mode select)

Mode	Data0	HP Sense terminal	Note
	D4		
BTL*	0	L	Differential Operation
SE*		H	Single Ended Operation
SE	1	L	Single Ended Operation
SE		H	Single Ended Operation

*Default Value

GainSel(External / Internal gain select)

Select	Data0	Note
	D3	
Internal Gain*	0	The gain is set with an internal circuit.
External Gain	1	The gain is set with an external circuit.

*Default Value

NJU7086

AUX(Auxiliary output High / Low select)

Control	Data0	Note
	D2	
High*	0	The AUX output is made High.
Low	1	The AUX output is made Low.

*Default Value

Mode(IC operating mode select)

Mode	Data0		STBY terminal	Note
	D1	D0		
STBY*	0	0	L	IC is non-active
STBY	0	1		
	1	0		
	1	1		
Charge	0	1	H	Reference Voltage Charge mode
Mute	1	0		Non output signal
Active	1	1		IC is active

*Default Value

Volume (Volume control)

Gain	Data1				
	D4	D3	D2	D1	D0
0dB	1	1	1	1	1
-1dB	1	1	1	1	0
-2dB	1	1	1	0	1
-3dB	1	1	1	0	0
-4dB	1	1	0	1	1
-5dB	1	1	0	1	0
-6dB	1	1	0	0	1
-7dB	1	1	0	0	0
-8dB	1	0	1	1	1
-10dB	1	0	1	1	0
-12dB	1	0	1	0	1
-14dB	1	0	1	0	0
-16dB	1	0	0	1	1
-18dB	1	0	0	1	0
-20dB	1	0	0	0	1
-22dB	1	0	0	0	0
-24dB	0	1	1	1	1
-26dB	0	1	1	1	0
-28dB	0	1	1	0	1
-30dB	0	1	1	0	0
-32dB	0	1	0	1	1
-34dB	0	1	0	1	0
-36dB	0	1	0	0	1
-38dB	0	1	0	0	0
-40dB	0	0	1	1	1
-44dB	0	0	1	1	0
-48dB	0	0	1	0	1
-52dB	0	0	1	0	0
-56dB	0	0	0	1	1
-60dB	0	0	0	1	0
-64dB	0	0	0	0	1
Mute*	0	0	0	0	0

*Default Value

■ TYPICAL CHARACTERISTICS

Supply Current vs Temperature
(BTL / SingleEnd)

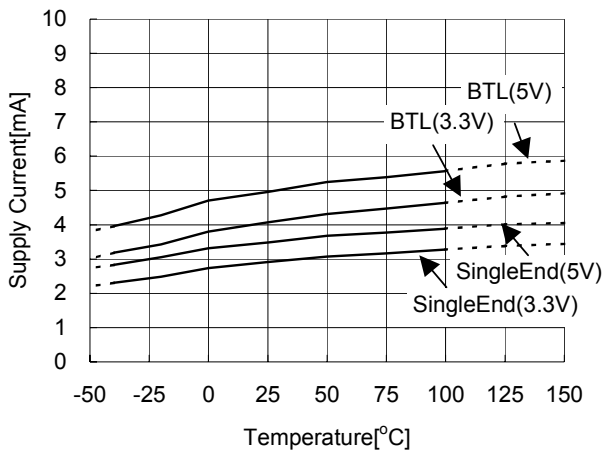

Supply Current vs Supply Voltage
(BTL / SingleEnd) Ta=25°C

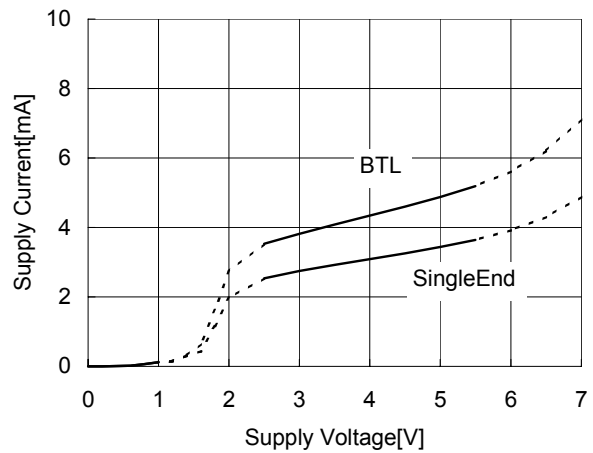

Supply Current vs Temperature
(charge mode)

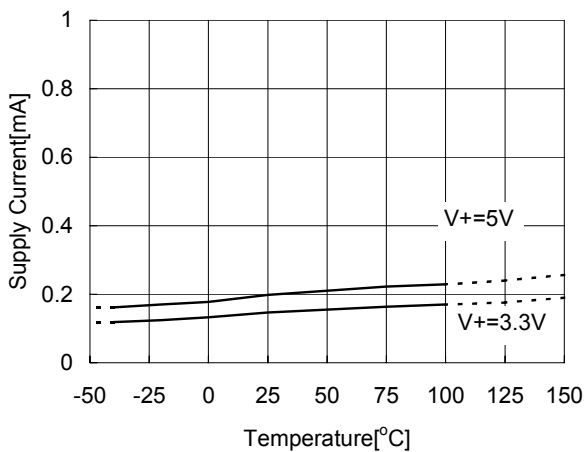

Supply Current vs Supply Voltage
(charge mode) Ta=25°C

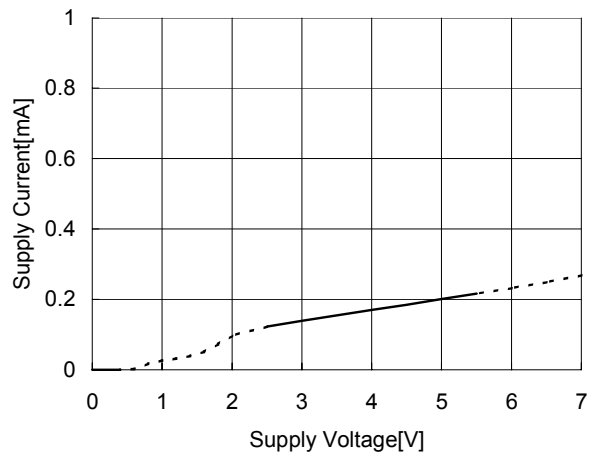

Supply Current vs Temperature
(STBY mode)

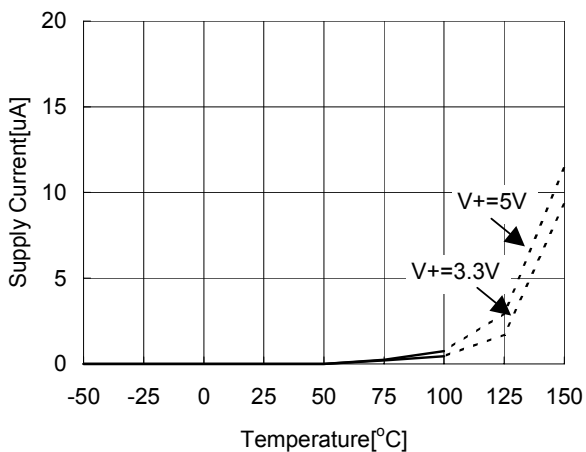

Supply Current vs Supply Voltage
(STBY mode) Ta=25°C

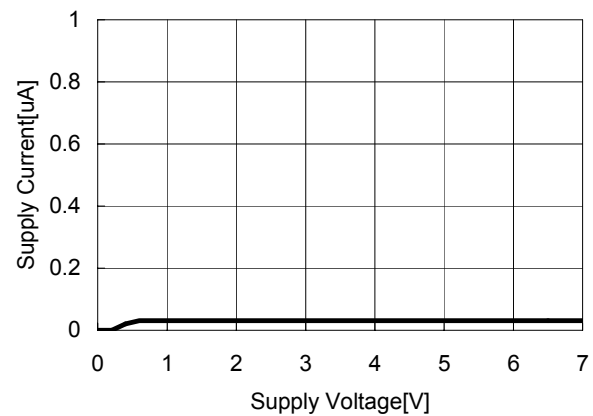

TYPICAL CHARACTERISTICS

ReferenceVoltage vs Temperature
(VrefIC)

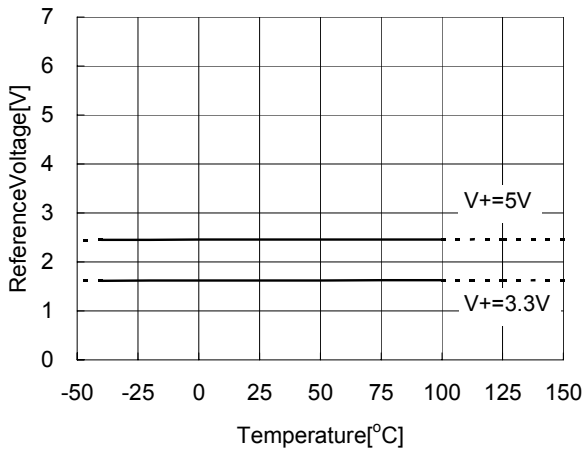

ReferenceVoltage vs Supply Voltage
(VrefIC)Ta=25°C

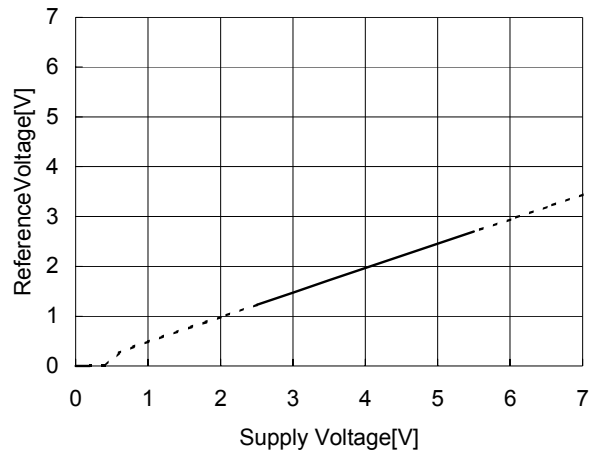

Vrefin vs Vrefout
V+=5V

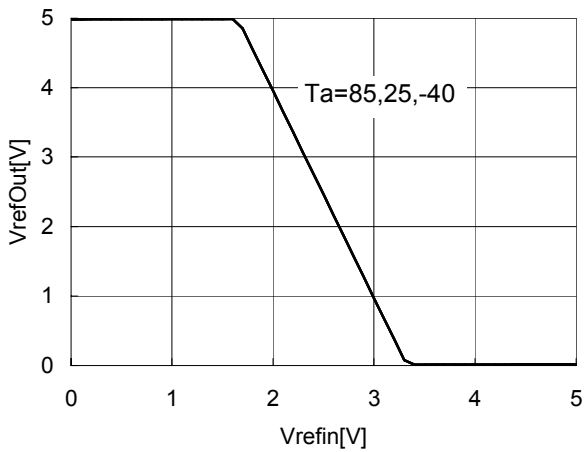

Supply Current vs STBY terminal voltage
V+=5V

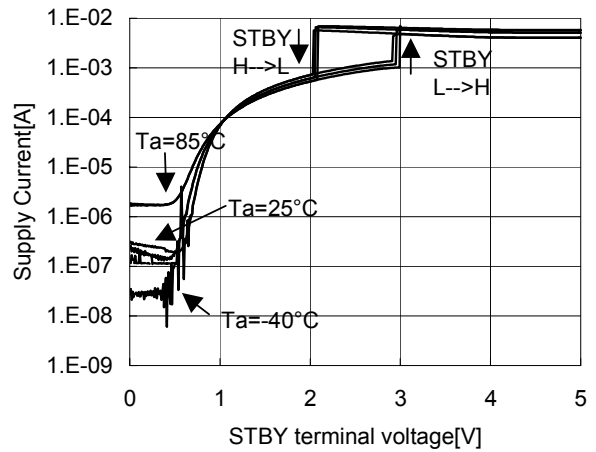

OutputNoise vs Temperature
V+=5V, filter=A-Weighted, Rg=0Ω
RL=8Ω(BTL), 32Ω(SingleEnd), 100kΩ(MonOut)

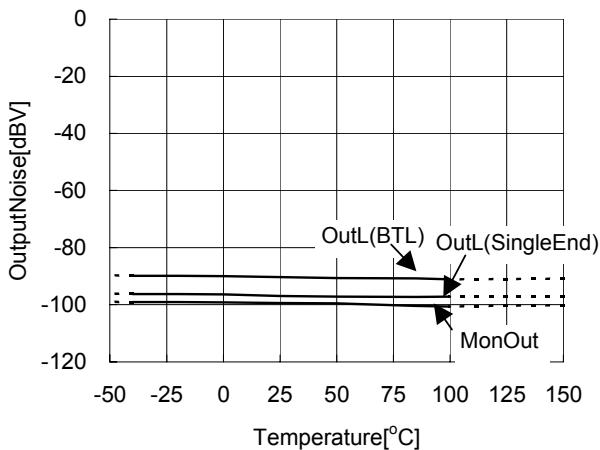

Voltage Gain vs Volume Control
V+=5V, f=1kHz, Vout=OUTL/R
InternalGain, RL=32Ω(SingleEnd)

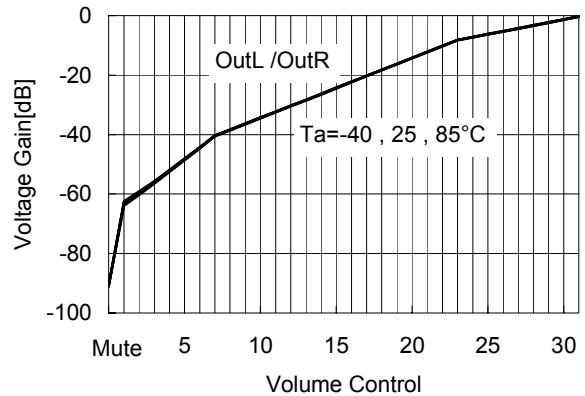

TYPICAL CHARACTERISTICS

SupplyCurrent vs Temperature(Thermal Shut Down)
 $V+=5V$, BTL , No Signal

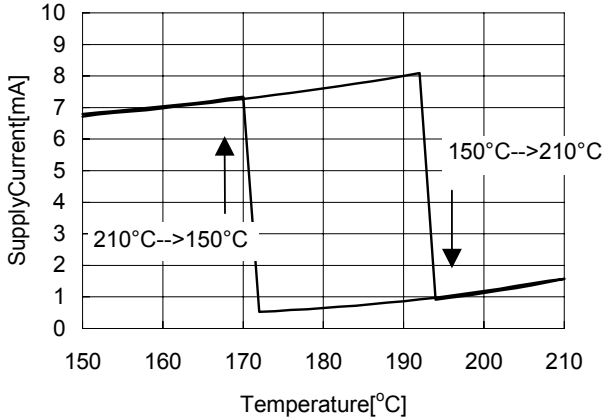

OutputVoltage vs Temperature(Thermal Shut Down)
 $V+=5V$, BTL , NoSignal

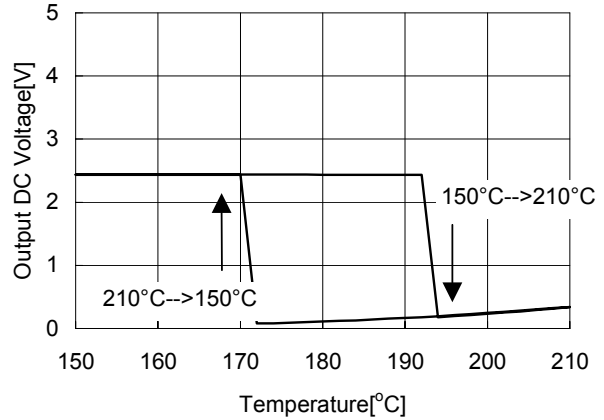

VoltageGain vs Frequency
 $V+=5V$, $V_{ol}=0dB$, InternalGain , $T_a=25^\circ C$
 $R_g=0\Omega$, $R_L=8\Omega$ (BTL), 32Ω (SingleEnd), $100k\Omega$ (MonOut)

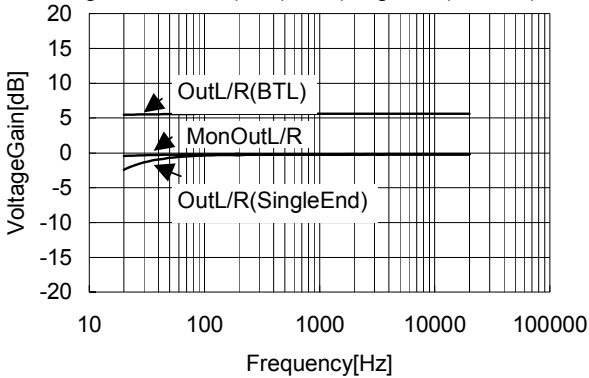

PSRR vs Frequency
 $V+=5V$, $V_{ripple}=100mV_{rms}$, $V_{ol}=0dB$, $T_a=25^\circ C$
 InternalGain , $R_g=0\Omega$, $R_L=32\Omega$ (SingleEnd), $100k\Omega$ (MonOut)

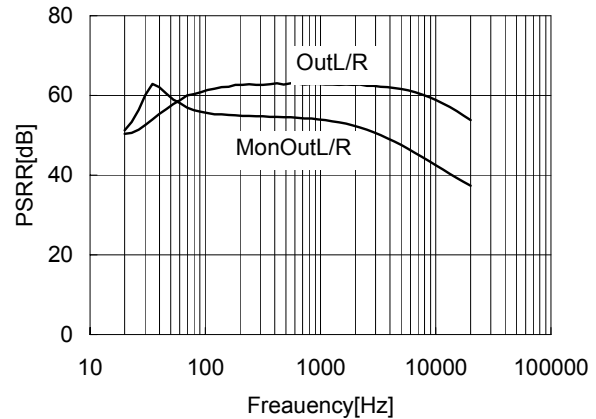

Channel Separation vs Frequency
 $V+=5V$, $V_{in}=1V_{rms}$, $V_{ol}=0dB$, $T_a=25^\circ C$
 InternalGain , $R_g=600\Omega$, $R_L=32\Omega$ (SingleEnd)

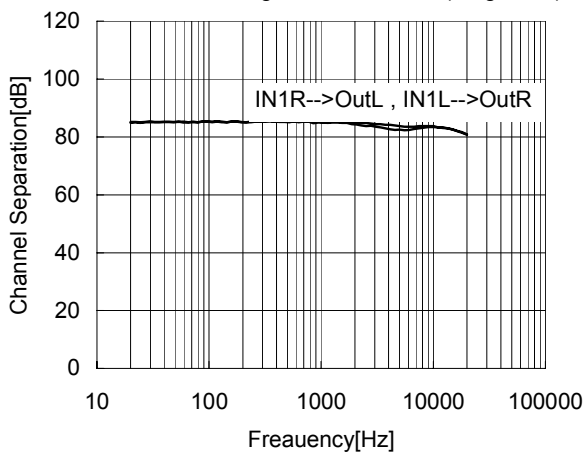

Cross Talk vs Frequency
 $V+=5V$, $V_{in}=1V_{rms}$, $V_{ol}=0dB$, $T_a=25^\circ C$
 InternalGain , $R_g=0\Omega$, $R_L=32\Omega$ (SingleEnd)

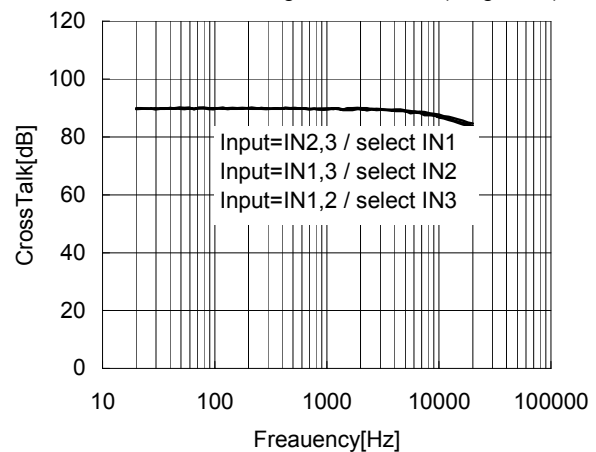

■ TYPICAL CHARACTERISTICS

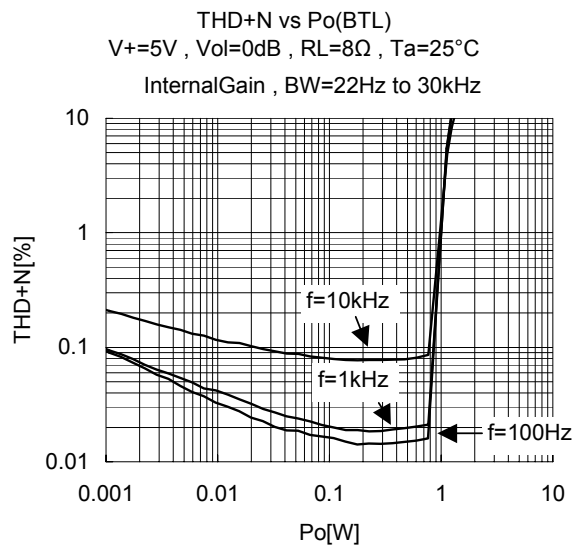
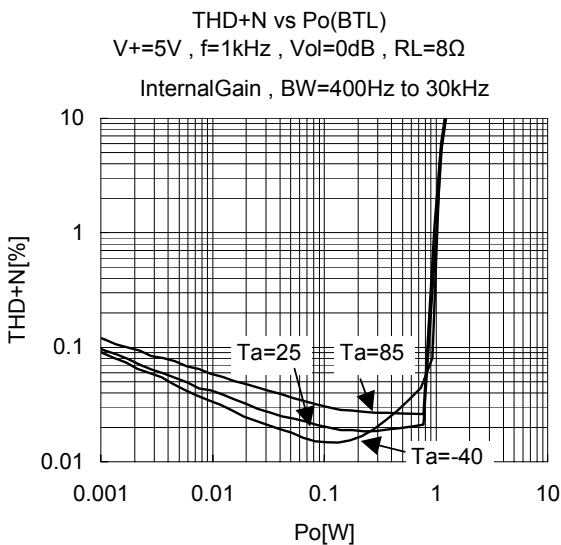
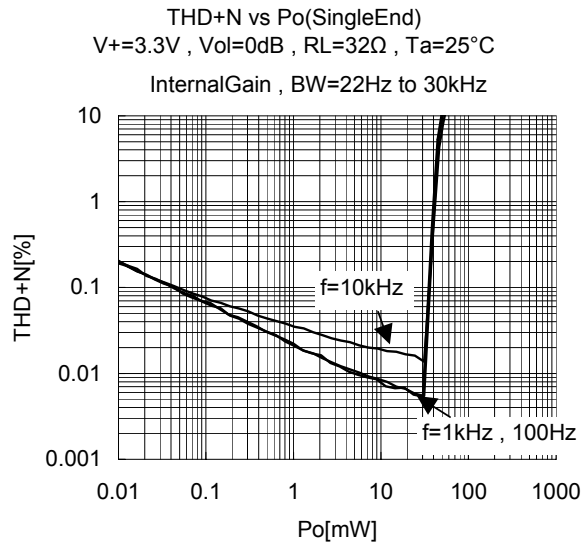
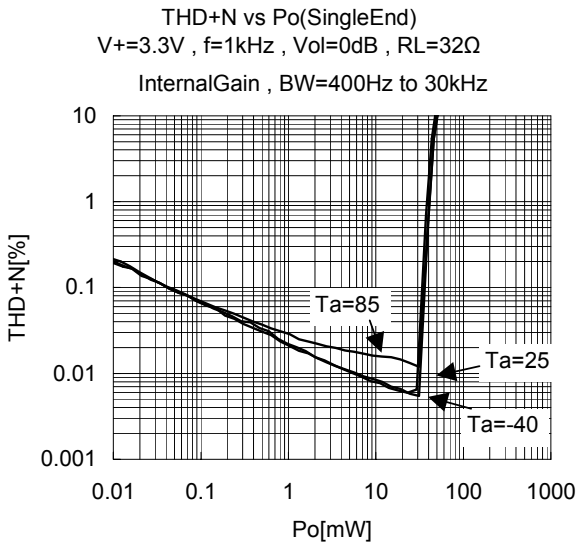
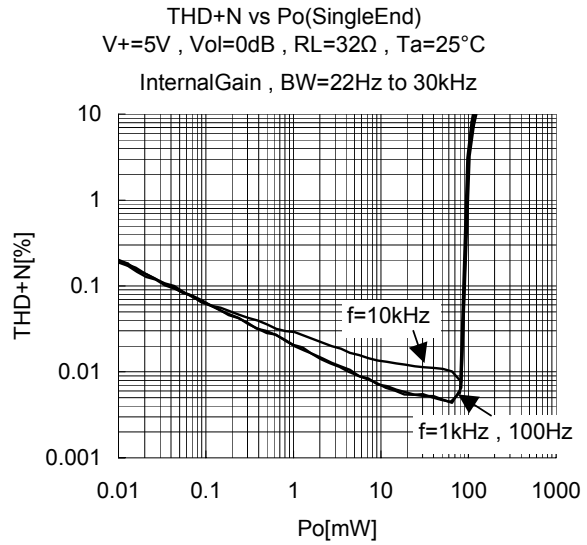
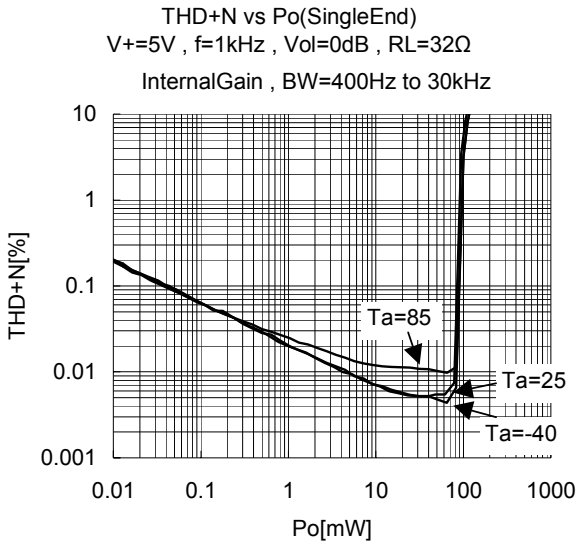

TYPICAL CHARACTERISTICS

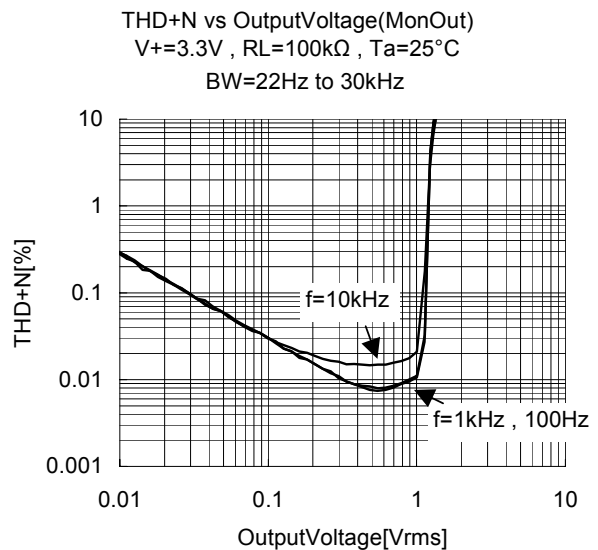
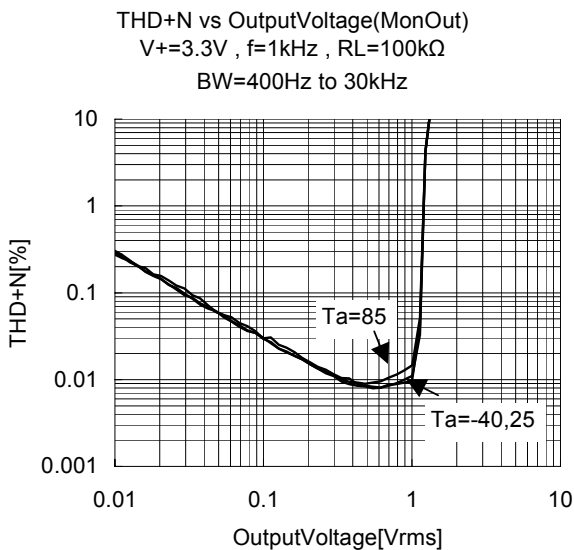
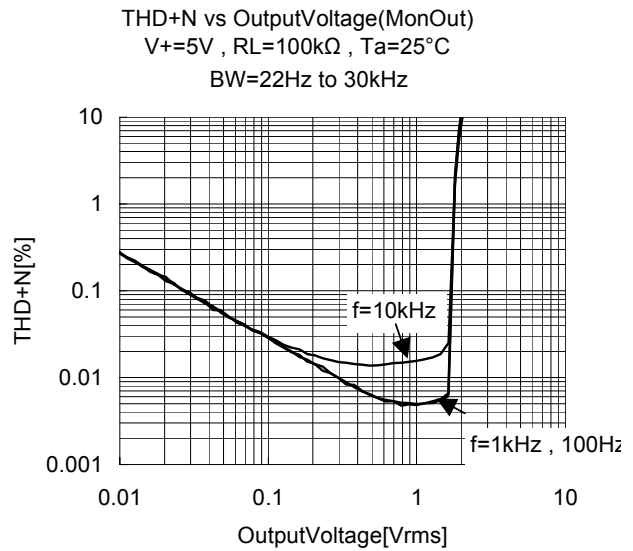
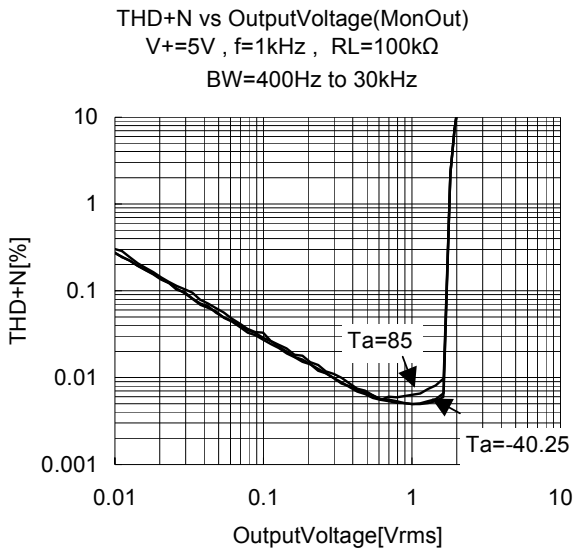
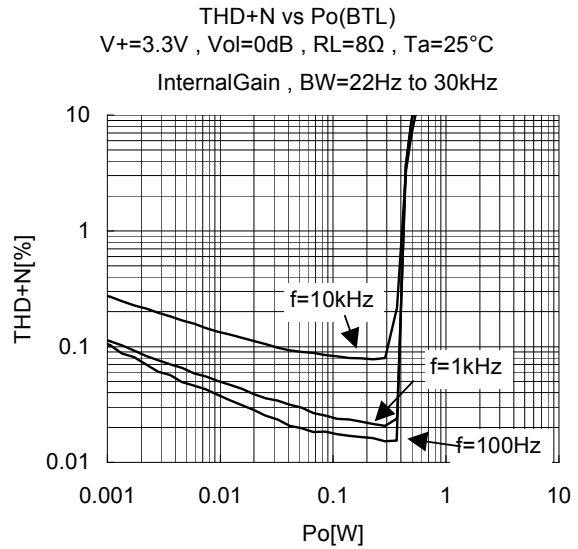
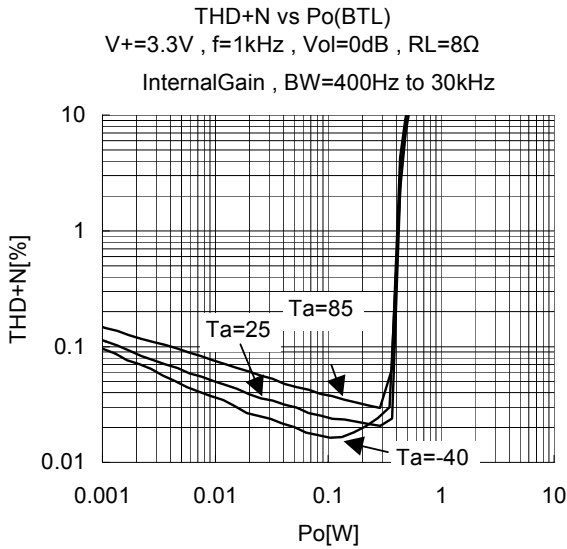

TYPICAL CHARACTERISTICS

PowerDissipation vs OutputPower(BTL)
 $f=1\text{kHz}$, $V_{ol}=0\text{dB}$, $R_L=8\Omega$, $T_a=25^\circ\text{C}$

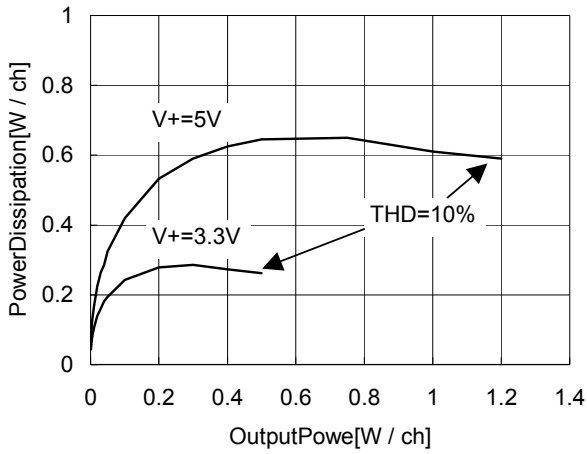

PowerDissipation vs OutputPower(SingleEnd)
 $f=1\text{kHz}$, $V_{ol}=0\text{dB}$, $R_L=32\Omega$, $T_a=25^\circ\text{C}$

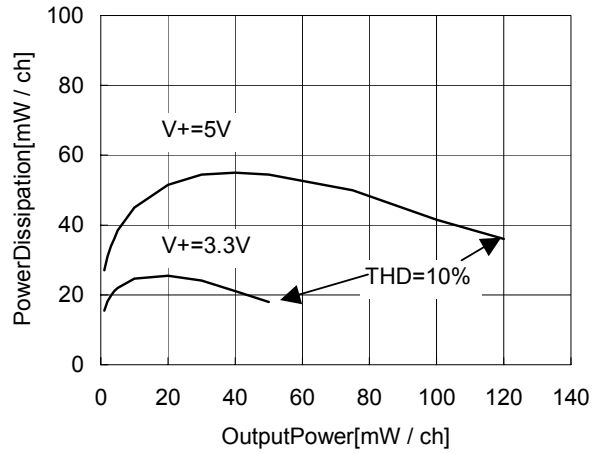

MaximumOutputVoltage vs LoadResistance
 MonOut , $f=1\text{kHz}$, $T_a=25^\circ\text{C}$, $\text{THD}=2\%$

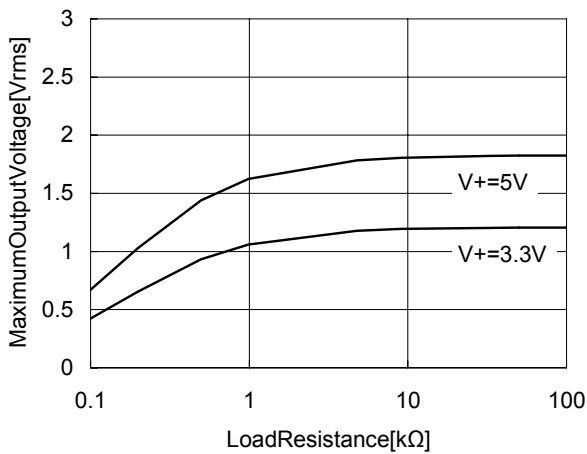

[CAUTION]

The specifications on this databook are only given for information , without any guarantee as regards either mistakes or omissions. The application circuits in this databook are described only to show representative usages of the product and not intended for the guarantee or permission of any right including the industrial rights.