

## 4in-1out Audio Selector with Isolation amplifier

### ■ GENERAL DESCRIPTION

The **NJM2754** is 4In-1out stereo audio Selector with ground noise isolation amplifiers. It contains dual channel differential amplifier.

It is developed for those car audio applications where long connections between head unit and other components are necessary and ground noise has to be eliminated.

### ■ PACKAGE OUTLINE

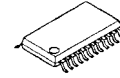

**NJM2754V**

### ■ FEATURES

- 4in-1out Stereo Audio Selector
- Operating Voltage 4.3 to 12V
- Operating Current 14mA(typ.)
- Common mode rejection ratio CMRR=60dB typ.
- Maximum Output Voltage 2Vrms min., @ THD=0.1%
- Supply Voltage Rejection Ratio 60dB typ.
- Total Harmonic Distortion 0.003% typ.
- Noise Output Voltage 1.7 $\mu$ Vrms typ.
- Bipolar Technology
- Package Outline SSOP20

### ■ BLOCK DIAGRAM

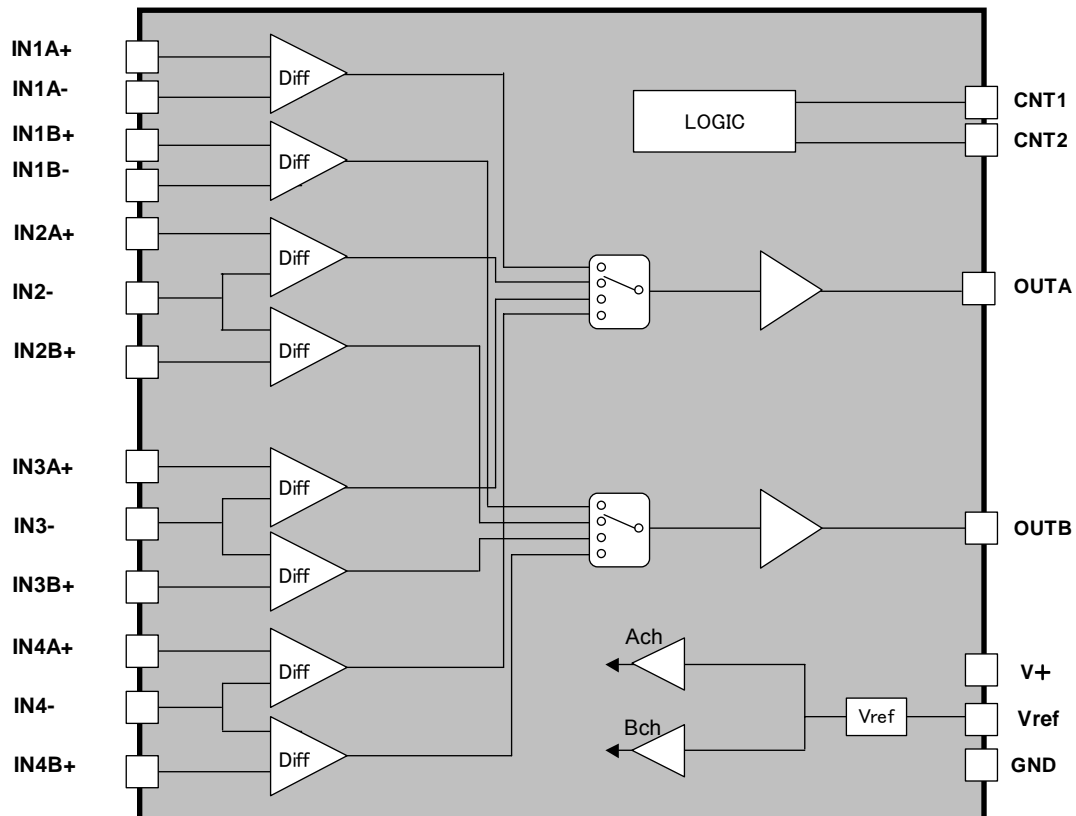

# NJM2754

## ■PIN CONFIGURATION

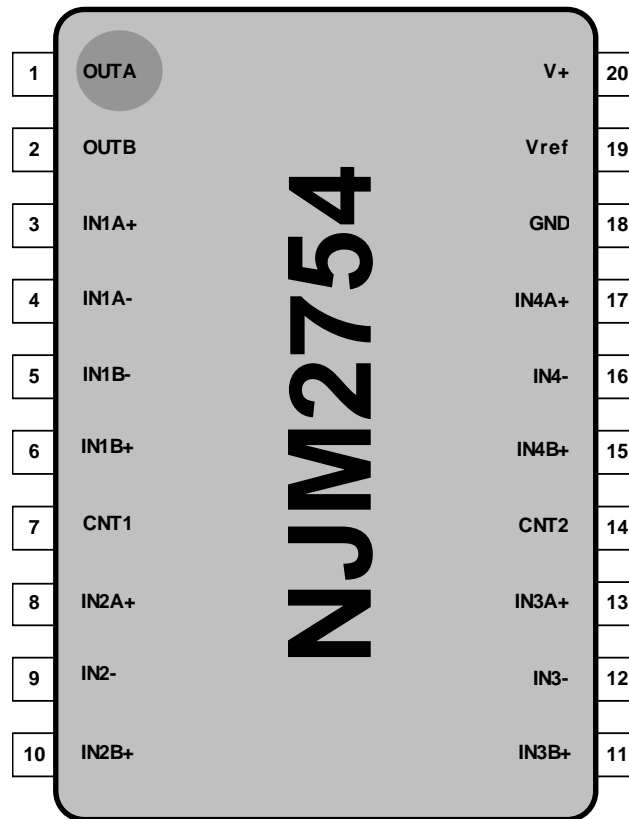

No.	SYMBOL	FUNCTION
1	OUTA	Ach Output
2	OUTB	Bch Output
3	IN1A+	Ach +Input 1
4	IN1A-	Ach -Input1
5	IN1B-	Bch -Input1
6	IN1B+	Bch +Input 1
7	CNT1	CONTROL 1
8	IN2A+	Ach +Input 2
9	IN2-	-Input2
10	IN2B+	Bch +Input 2
11	IN3B+	Bch +Input 3
12	IN3-	-Input3
13	IN3A+	Ach +Input 3
14	CNT2	CONTROL 2
15	IN4B+	Bch +Input 4
16	IN4-	-Input4
17	IN4A+	Ach +Input 4
18	GND	Ground
19	Vref	Reference Voltage
20	V+	Power Supply

## ■ABSOLUTE MAXIMUM RANGES (Ta=25°C)

PARAMETER	SYMBOL	RANGE	UNIT
Supply Voltage	V <sup>+</sup>	+15	V
Maximum Input Voltage	V <sub>IM</sub>	0 to V <sup>+</sup> (*)	V
Power Dissipation	P <sub>D</sub>	SSOP20 : 700 <sup>(1)</sup> 950 <sup>(2)</sup> <small>(1) EIA/JEDEC STANDARD Test board (76.2x114.3x1.6mm, 2layer, FR-4) mounting (2) EIA/JEDEC STANDARD Test board (76.2x114.3x1.6mm, 4layer, FR-4) mounting</small>	mW
Operating Temperature	Topr	-40 to +85	°C
Storage Temperature	Tstg	-40 to +150	°C

## ■ELECTRICAL CHARACTERISTIC (V<sup>+</sup>=9V, Ta=25°C)

PARAMETER	SYMBOL	TEST CONDITION	MIN.	TYP.	MAX.	UNIT
<b>DC CHARACTERISTIC</b>						
Operating Voltage	V <sup>+</sup>		4.3	9	12	V
Operating Current	I <sub>CC</sub>	No Signal	-	14	20	mA
Reference Voltage	V <sub>REF</sub>		3.8	4.3	4.8	V
<b>AC CHARACTERISTIC</b> (Non-inverting circuit, f=1kHz, V <sub>in</sub> =1V <sub>rms</sub> , R <sub>g</sub> =0Ω, R <sub>L</sub> =10kΩ unless otherwise specified)						
Voltage Gain	G <sub>V</sub>		-1.0	0.0	+1.0	dB
Cross Talk	CT	f=1kHz, A-Weighted	100	110	-	dB
Channel Separation	CS	f=1kHz, A-Weighted	90	110	-	dB
Channel Balance	BAL		-	-	0.5	dB
Roll-off High Frequency	f <sub>RH</sub>	-1dB	100	-	-	kHz
Input Resistance	R <sub>IN</sub>		85	105	125	kΩ
Output Resistance	R <sub>OUT</sub>		-	90	-	Ω
Maximum Output Voltage	V <sub>OM</sub>	THD=0.1%, f = 1kHz	2	2.5	-	V <sub>rms</sub>
Noise Output Voltage	V <sub>NO</sub>	Rg=600Ω, A-weighted	-	1.7	2.5	μV <sub>rms</sub>
Total Harmonic Distortion	THD	f=1kHz, V <sub>IN</sub> =1V <sub>rms</sub> , BW=400Hz to 30kHz	-	0.003	0.01	%
Common Mode Rejection Ratio	CMRR		50	60	-	dB
Common Mode Input Voltage	V <sub>icm</sub>	CMRR=50dB	-	2	-	V <sub>rms</sub>
Supply Voltage Rejection Ratio	SVR	f=100Hz, V <sub>ripple</sub> =100mV <sub>rms</sub>	55	65	-	dB
Switch-ON Voltage Level	V <sub>CH</sub>	V <sub>CNT</sub> =High Level	2.3	-	V <sup>+</sup>	V
Switch-OFF Voltage Level	V <sub>CL</sub>	V <sub>CNT</sub> =Low Level	-	-	0.8	V

## ■SWITCH CONTROL LOGIC

CNT2	CNT1	Input Ach / Bch
L	L	1
L	H	2
H	L	3
H	H	4

## APPLICATION CIRCUIT

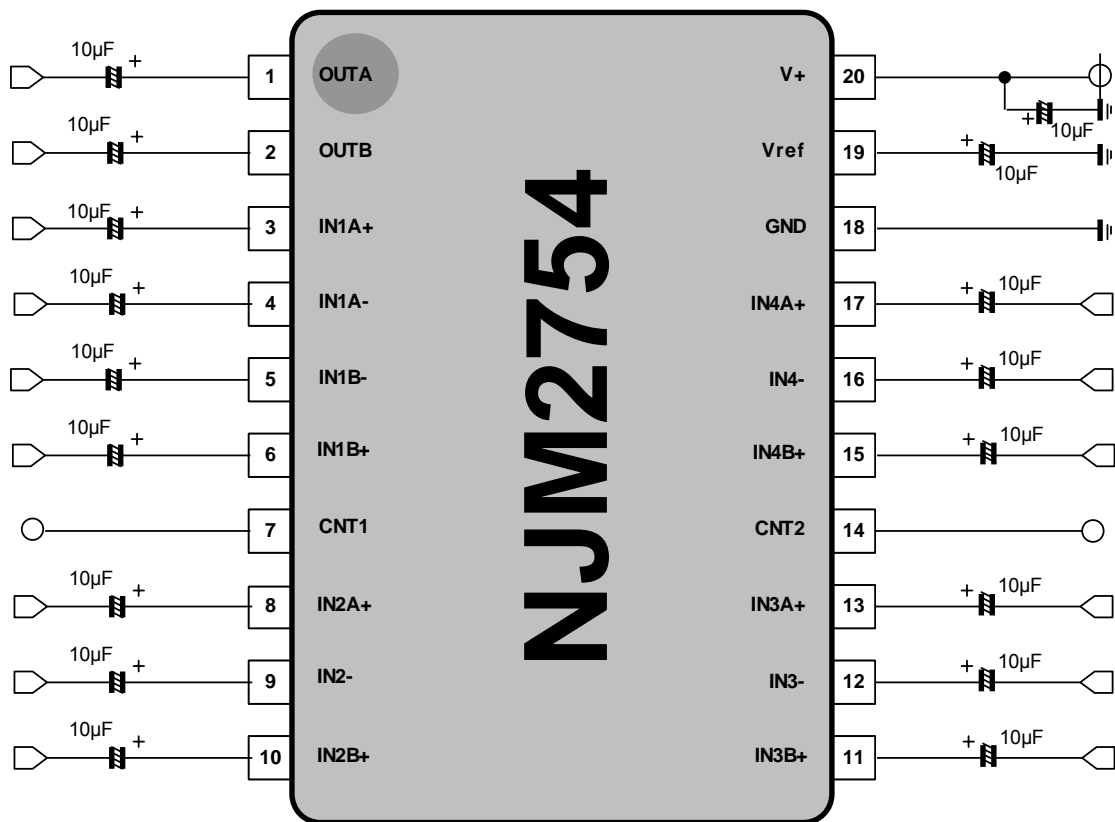

## TYPICAL CHARACTERISTICS

ICC vs Supply Voltage  
No signal

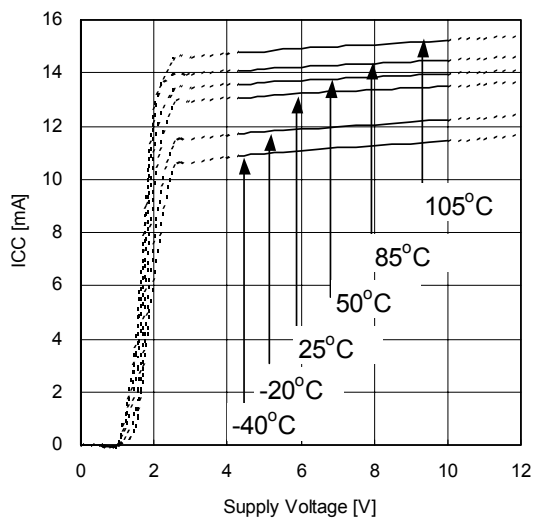

Vref vs Supply Voltage  
No signal, T=105,85,50,25,-20,-40°C

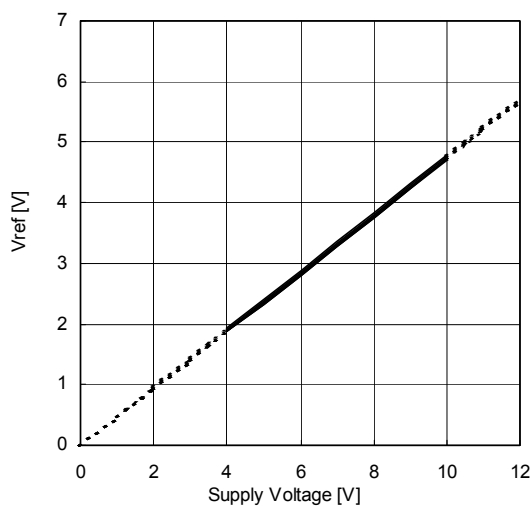

Gain Output vs Frequency  
V<sup>r</sup>=9V, V<sub>in</sub>=1V<sub>rms</sub>, INA1-Aout, Non-Inverting circuit  
T=105,85,50,25,-20,-40°C

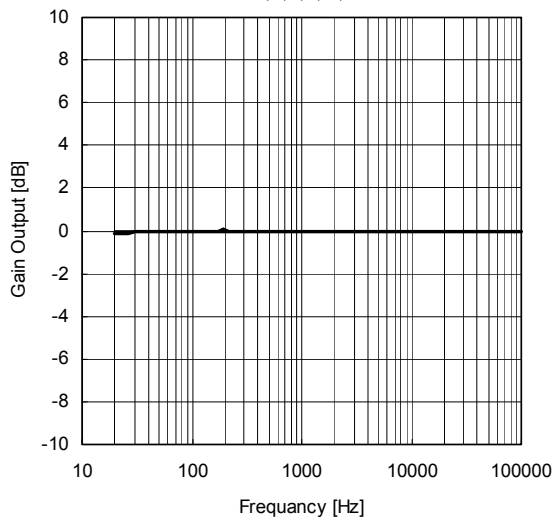

Volume Gain output vs Frequency  
V<sup>r</sup>=9V, V<sub>in</sub>=1V<sub>rms</sub>, INA1-Aout, Inverting circuit  
T=105,85,50,25,-20,-40°C

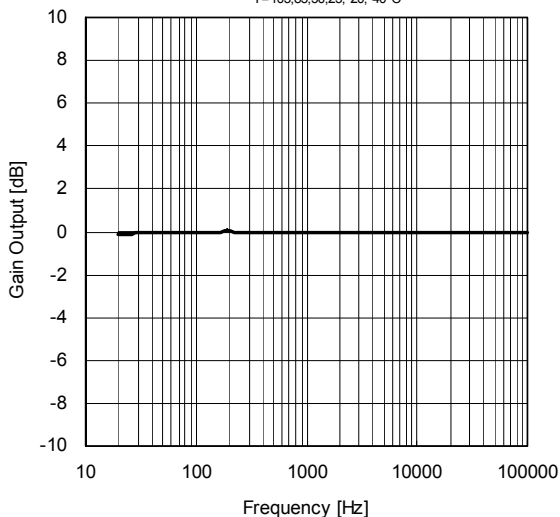

Maximum Output Voltage vs Supply Voltage  
V<sup>r</sup>=+9V, THD=0.1%, INA1-Aout, Non-Inverting circuit  
T=105,85,50,25,-20,-40°C

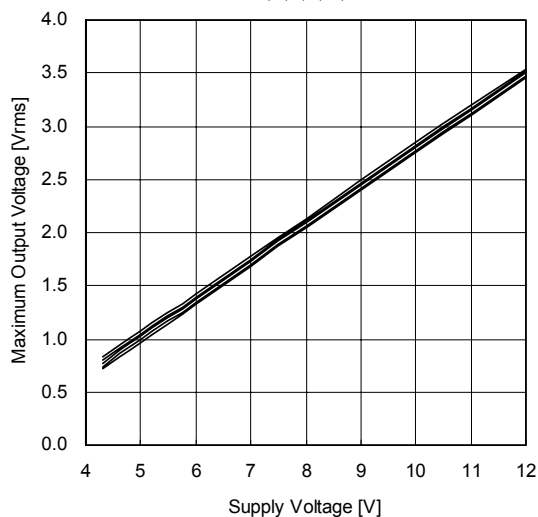

Maximum Output Voltage vs Supply Voltage  
V<sup>r</sup>=+9V, THD=0.1%, I/O: INA1-Aout, Reversing circuit  
T=105,85,50,25,-20,-40°C

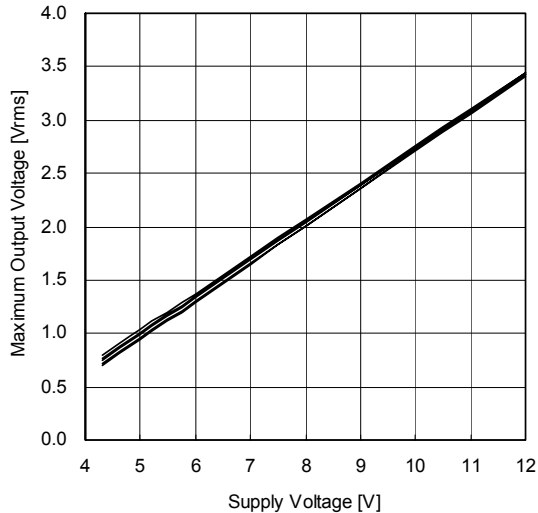

## TYPICAL CHARACTERISTICS

CMR vs Frequency  
 $V=+9V$ ,  $V_{in}=1V_{rms}$ ,  $O_{UT,A}$ ,  
 $T=105,85,50,25,-20,-40^{\circ}C$

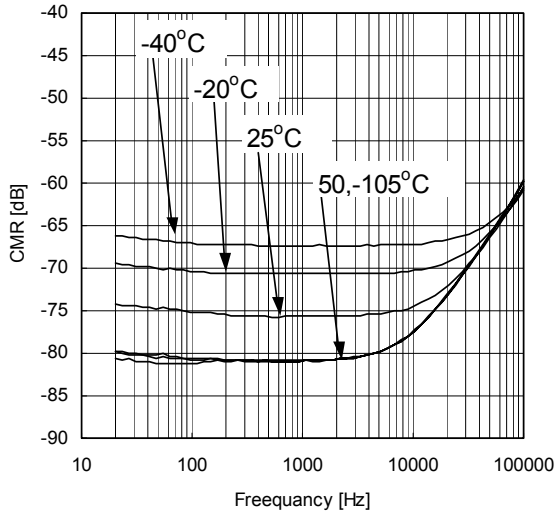

CMR vs Input Voltage  
 $V=+9V$ ,  $f=1kHz$ ,  $BW=400Hz-30kHz$ ,  $O_{UT,A}$ ,  
 $T=105,85,50,25,-20,-40^{\circ}C$

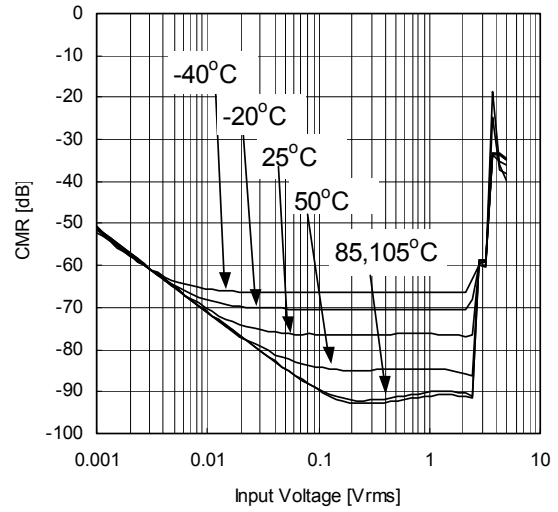

Channel Separation vs Frequency  
 $V=+9V$ ,  $V_{in}=1V_{rms}$ ,  $BW=10-80kHz$ ,  $I/O: INB1+-outA$ ,  
 Non-reversing circuit,  $T=105,85,50,25,-20,-40^{\circ}C$

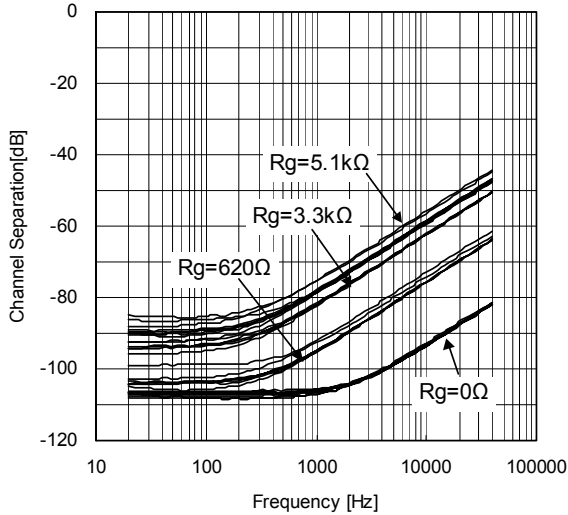

Channel Separation vs Frequency  
 $V=+9V$ ,  $V_{in}=1V_{rms}$ ,  $BW=10-80kHz$ ,  $I/O: INB1--outA$ ,  
 Reversing circuit,  $T=105,85,50,25,-20,-40^{\circ}C$

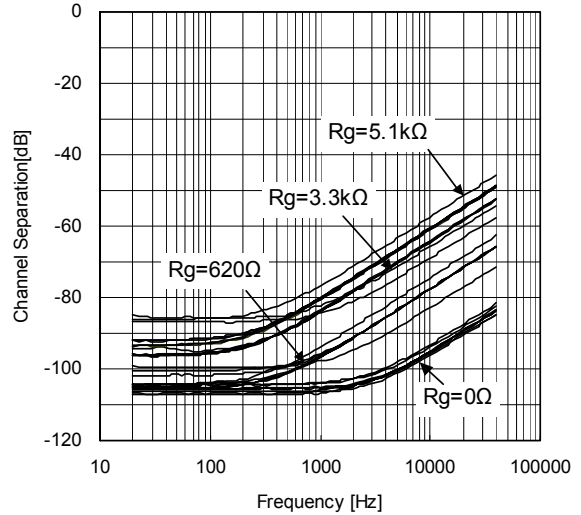

Cross Talk vs Frequency  
 $V=+9V$ ,  $V_{in}=1V_{rms}$ ,  $BW=10-80kHz$ , Non-reversing circuit  
 $I/O: INA2+, INA3+, INA4+, OutA$ ,  $T=105,85,50,25,-20,-40^{\circ}C$

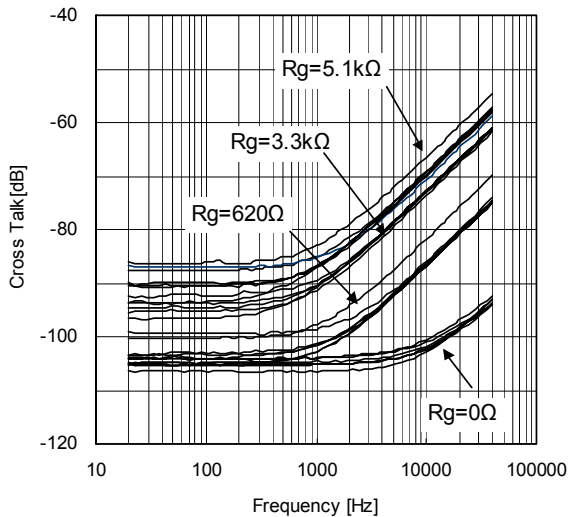

Cross Talk vs Frequency  
 $V=+9V$ ,  $V_{in}=1V_{rms}$ ,  $BW=10-80kHz$ , Reversing circuit  
 $I/O: INA2-, INA3-, INA4-, OutA$ ,  $T=105,85,50,25,-20,-40^{\circ}C$

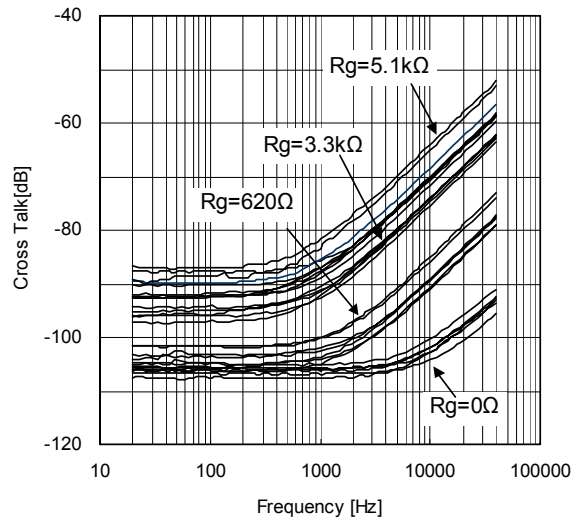

## TYPICAL CHARACTERISTICS

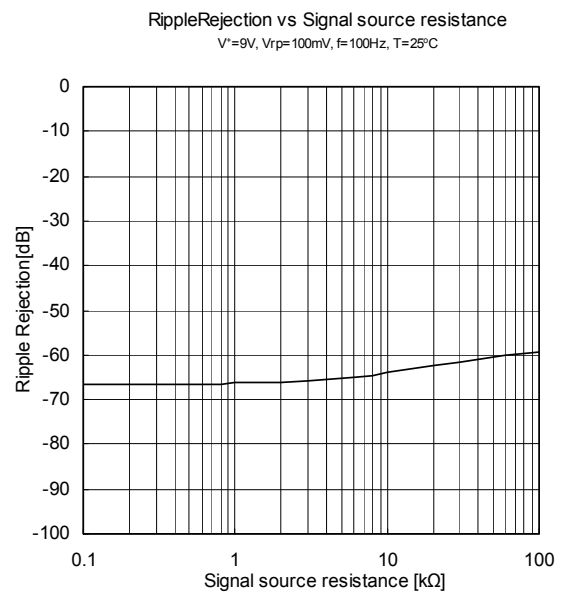
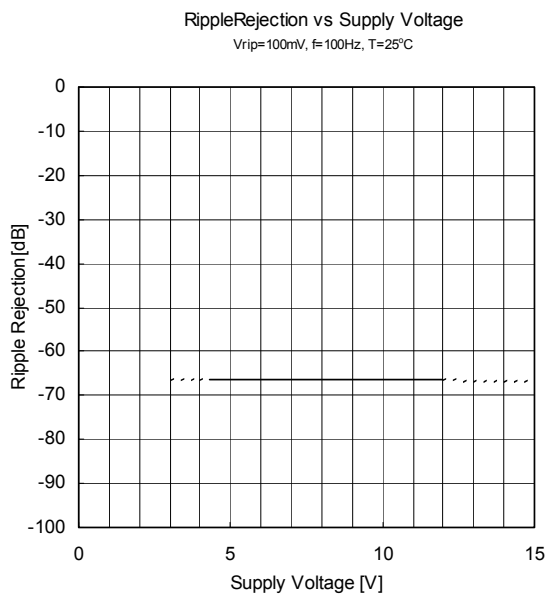
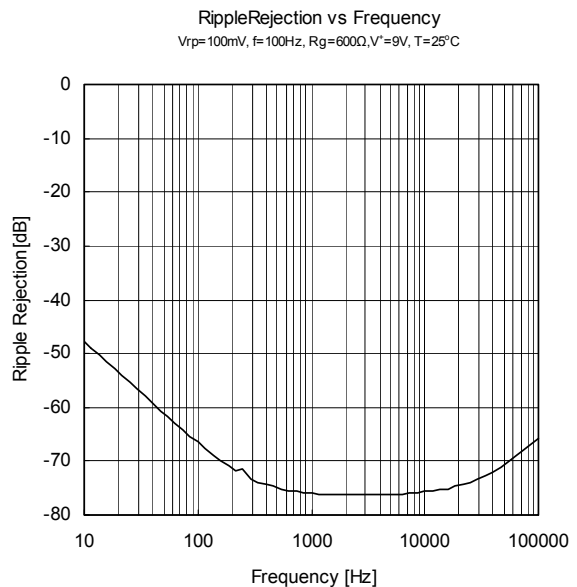
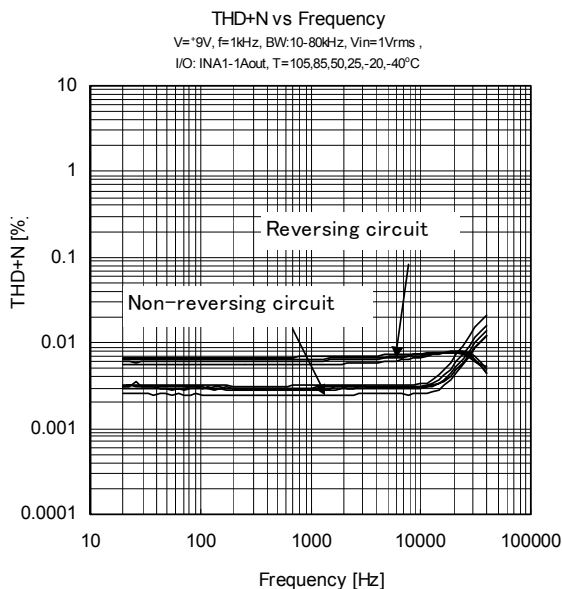
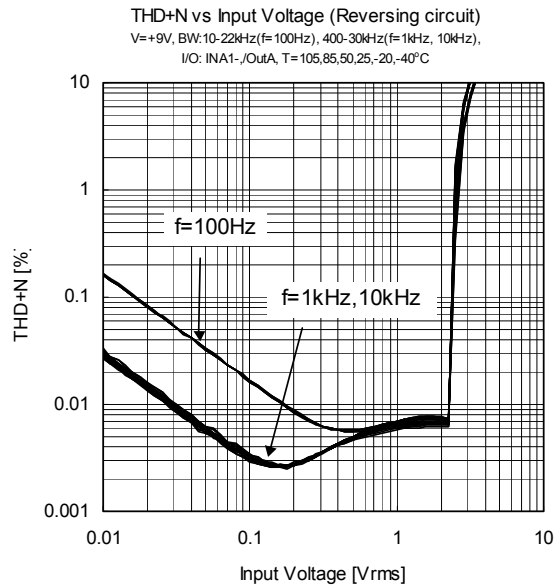
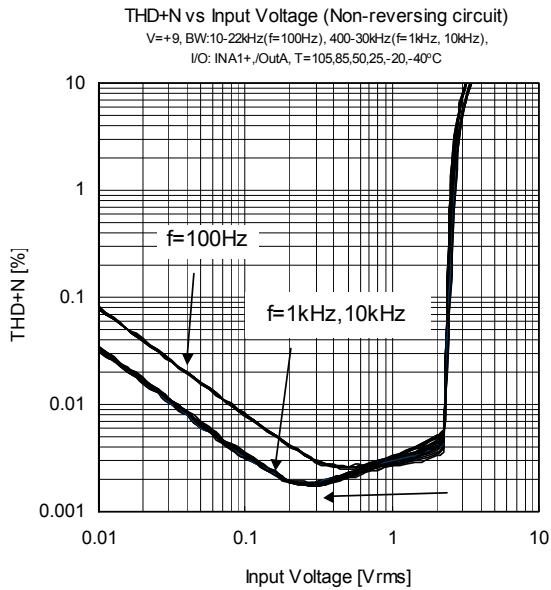



## ■ TYPICAL CHARACTERISTICS

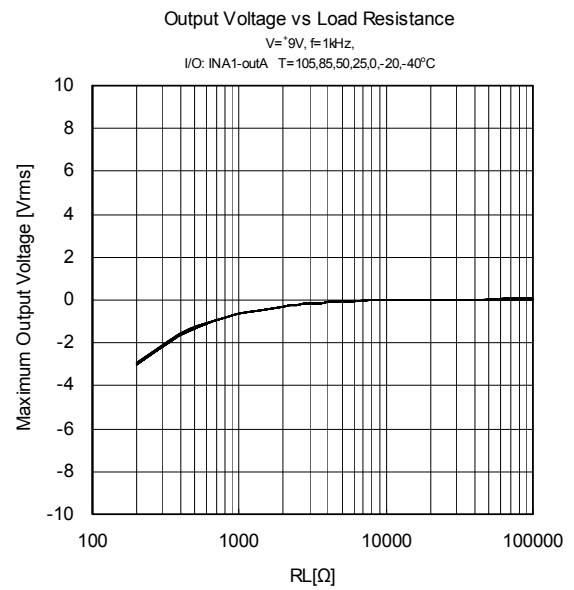
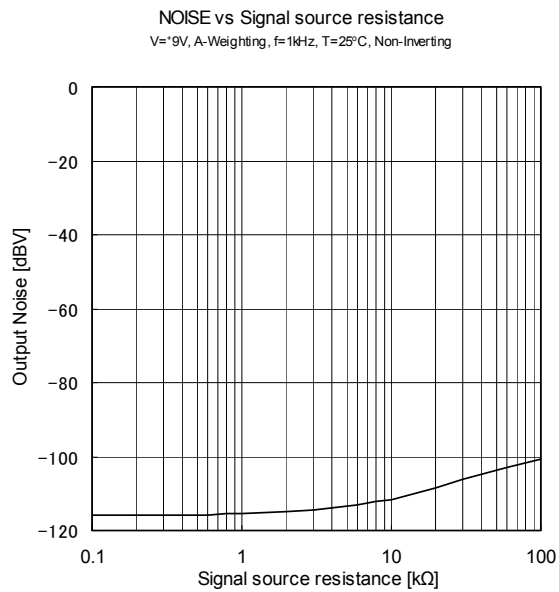

**[CAUTION]**

The specifications on this databook are only given for information, without any guarantee as regards either mistakes or omissions. The application circuits in this databook are described only to show representative usages of the product and not intended for the guarantee or permission of any right including the industrial rights.