

## Quad Boost Amplifier

### ■ GENERAL DESCRIPTION

The **NJM2792** is a quad boost amplifier designed for car audio system. It expands the frequency characteristics by high slew rate.

It can swing 14V peak-to-peak output voltage at 9V. It consists of four channel non-inverting amplifier with the gain of 8dB.

It is suitable for car audio system and other boost amplifier system.

### ■ PACKAGE OUTLINE

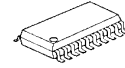

NJM2792V

### ■ FEATURES

- Operating Voltage (6 to 11V)
- Operating Current (12mA typ. )
- Boost output Function ( $V_o=14V_{pp}:@V^+=9V$ )
- Maximum Output Voltage (4.5Vrms typ., @ f=100kHz )
- Supply Voltage Rejection Ratio (50dB typ. )
- Total Harmonic Distortion (0.003% typ. )
- Noise Output Voltage (5 $\mu$ Vrms typ. )
- Bipolar Technology
- Package Outline SSOP20

### ■ BLOCK DIAGRAM

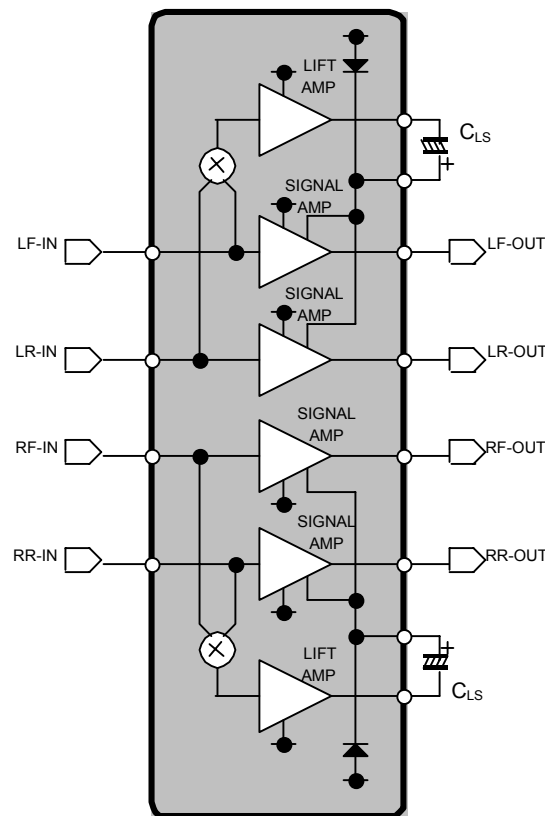

## ■PIN CONFIGURATION

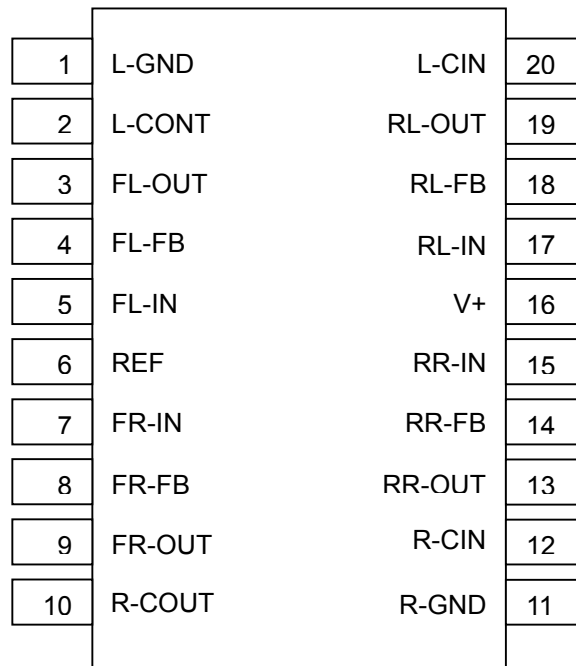

No.	Symbol	Function	No.	Symbol	Function
1	L-GND	Ground for Left Channel	11	R-GND	Ground for Right Channel
2	L-COUT	Capacitor for - Level Shift Left Channel	12	R-CIN	Capacitor for + Level Shift Right Channel
3	FL-OUT	Output for Front Left Channel	13	RR-OUT	Output for Rear Right Channel
4	FL-FB	- Input for Front Left Channel	14	RR-FB	- Input for Rear Right Channel
5	FL-IN	+ Input for Front Left Channel	15	RR-IN	+ Input for Rear Right Channel
6	REF	Reference Voltage	16	V+	Power Supply
7	FR-IN	+ Input for Front Right Channel	17	RL-IN	+ Input for Rear Left Channel
8	FR-FB	- Input for Front Right Channel	18	RL-FB	- Input for Rear Left Channel
9	FR-OUT	Output for Front Right Channel	19	RL-OUT	Output for Rear Left Channel
10	R-COUT	Capacitor for - Level Shift Right Channel	20	L-CIN	Capacitor for + Level Shift Left Channel

## ■ ABSOLUTE MAXIMUM RANGES (Ta=25°C)

PARAMETER	SYMBOL	RANGE	UNIT
Supply Voltage	V <sup>+</sup>	+15	V
Power Dissipation	P <sub>D</sub>	550 NOTE: EIA/JEDEC STANDARD Test board (76.2x114.3x1.6mm, 2layer, FR-4) mounting	mW
Operating Temperature	Topr	-40 to +85	°C
Storage Temperature	Tstg	-40 to +125	°C

## ■ ELECTRICAL CHARACTERISTIC (V<sup>+</sup>=9V, Ta=25°C)

PARAMETER	SYMBOL	TEST CONDITION	MIN.	TYP.	MAX.	UNIT
<b>DC CHARACTERISTIC</b>						
Operating Voltage	V <sup>+</sup>		6.0	9.0	11.0	V
Operating Current	I <sub>CC</sub>	No Signal	-	12.0	18.0	mA
Output Voltage	V <sub>ODC</sub>		-	7.8	-	V
<b>AC CHARACTERISTIC (f=1kHz, V<sub>O</sub>=1Vrms, R<sub>L</sub>=10kΩ)</b>						
Voltage Gain	A <sub>v</sub>		7.5	8.0	8.5	dB
Channel Separation 1	CS1	R <sub>S</sub> =600Ω, V <sub>O</sub> =1Vrms, f = 1kHz, Front channel vs. Rear channel	70	80	-	dB
Channel Separation 2	CS2	R <sub>S</sub> =600Ω, V <sub>O</sub> =1Vrms, f = 1kHz, L channel vs. R channel	-	100	-	dB
Channel Balance	BAL		-	-	0.5	dB
Roll-off Low Frequency	f <sub>RL</sub>	-1dB	-	5	-	Hz
Roll-off High Frequency	f <sub>RH</sub>	-1dB	100	-	-	kHz
Input Resistance	R <sub>IN</sub>		44	60	76	kΩ
Output Resistance	R <sub>OUT</sub>		-	2	-	Ω
Maximum Output Voltage 1	V <sub>OM1</sub>	THD=0.1%, f = 1kHz	5.0	5.2	-	Vrms
Maximum Output Voltage 2	V <sub>OM2</sub>	THD=1%, f = 100kHz	-	4.5	-	Vrms
Noise Output Voltage	V <sub>NO</sub>	R <sub>S</sub> =0Ω, A-Weighting	-	5	10	μVrms
Total Harmonic Distortion	THD1	f=1kHz, V <sub>O</sub> =3Vrms, A-Weighting	-	0.003	0.01	%
	THD2	f=17Hz to 20kHz, V <sub>O</sub> =3Vrms, A-Weighting	-	0.01	-	%
Supply Voltage Rejection Ratio	SVR1	R <sub>S</sub> =0Ω, f=1kHz, V <sub>RP</sub> =100mVrms	55	-	-	dB
	SVR2	R <sub>S</sub> =0Ω, f=20Hz to 20kHz, V <sub>RP</sub> =100mVrms	-	50	-	dB

## ■ TERMINAL DESCRIPTION

PIN NO.	SYMBOL	FUNCTION	EQUIVALENT CIRCUIT	TERMINAL DC VOLTAGE
2 10	L-COUT R-COUT	Capacitor for - Level Shift Left Channel Capacitor for - Level Shift Right Channel	<p>2PIN, 10PIN</p>	$(V^+ - 1.4) \times 0.09$ [V]
12 20  3 9 13 19	R-CIN L-CIN  FL-OUT FR-OUT RR-OUT RL-OUT	Capacitor for + Level Shift Right Channel Capacitor for + Level Shift Left Channel  Output for Front Left Channel Output for Front Right Channel Output for Rear Right Channel Output for Rear Left Channel	<p>12PIN, 20PIN  3PIN, 9PIN, 13PIN, 19PIN</p>	$V^+ - 0.7$ [V] (12,20PIN)  $V^+ - 1.4$ [V] (3,9,13,19PIN)
4 8 14 18  5 7 15 17	FL-FB FR-FB RR-FB RL-FB  FL-IN FR-IN RR-IN RL-IN	- Input for Front Left Channel - Input for Front Right Channel - Input for Rear Right Channel - Input for Rear Left Channel  + Input for Front Left Channel + Input for Front Right Channel + Input for Rear Right Channel + Input for Rear Left Channel	<p>5PIN, 7PIN, 15PIN, 17PIN  4PIN, 8PIN, 14PIN, 18PIN</p>	$(V^+ - 1.4) \times 0.4$ [V]

■ TERMINAL DESCRIPTION

PIN NO.	SYMBOL	FUNCTION	EQUIVALENT CIRCUIT	TERMINAL DC VOLTAGE
6	REF	Reference Voltage		$(V^+ - 1.4) \times 0.6$ [V]

# NJM2792

## APPLICATION CIRCUIT

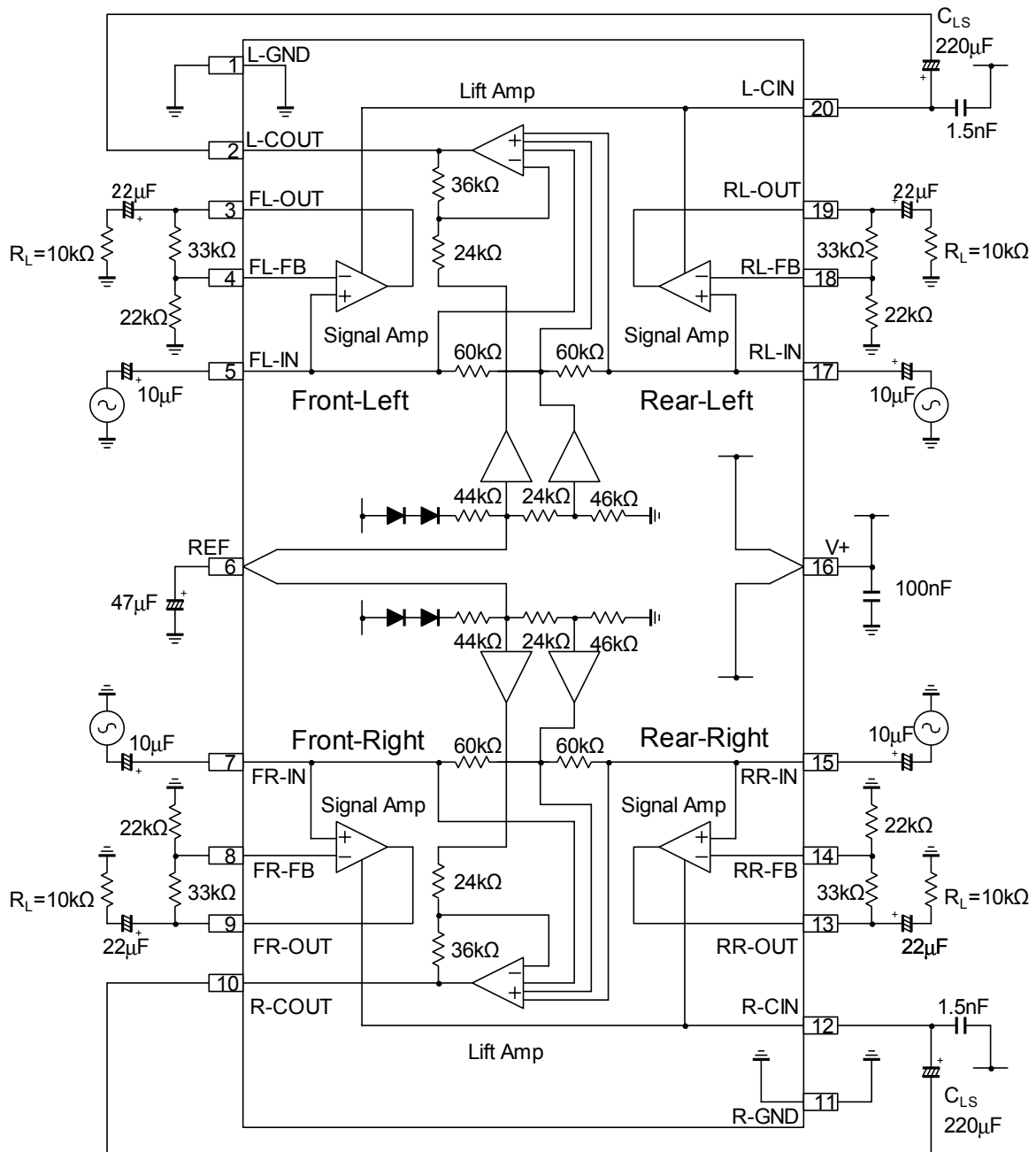

## APPLICATION NOTE

### OPERATING PRINCIPLE

Figure 1 is block diagram of NJM2792. A right channel and a left channel of figure are the same compositions. Only the reference voltage terminal and the power-supply voltage terminal are common between channels. One channel is composed of two signal amplifiers, one lift amplifier, the reference voltage, and the bias.

The signal amplifier is non-reverting amplifier which gain(+8dB) is set by external resistances. However, to achieve the function of the boost, the output bias point is set near  $V^+ [=V^+ - 1.4]$ . And, the power-supply voltage of the signal amplifier is supplied from the lift amplifier output.

The lift amplifier lifts the power-supply voltage of the signal amplifier more than  $V^+$  by the charge pump mechanism. However, unlike a charge pump, the lift amplifier lifts up voltage only when an input signal swings above center. The output bias point of the lift amplifier is set near  $GND [= (V^+ - 1.4) * 0.09]$ . When the input signal swings below center, the power supply of the signal amplifier is supplied from  $V^+$  through the diode.

Figure 2 shows the signal operation and the voltage.  $V^+/CIN/OUT/COUT$  shows terminal voltage. The NJM2792 can output more than the power-supply voltage when power-supply voltage of the signal amplifier (CIN) is more than the output voltage.

The NJM2792 does not have standby function and mute function. The stability operation is after the capacitor of the reference voltage terminal is charged at power supply on.

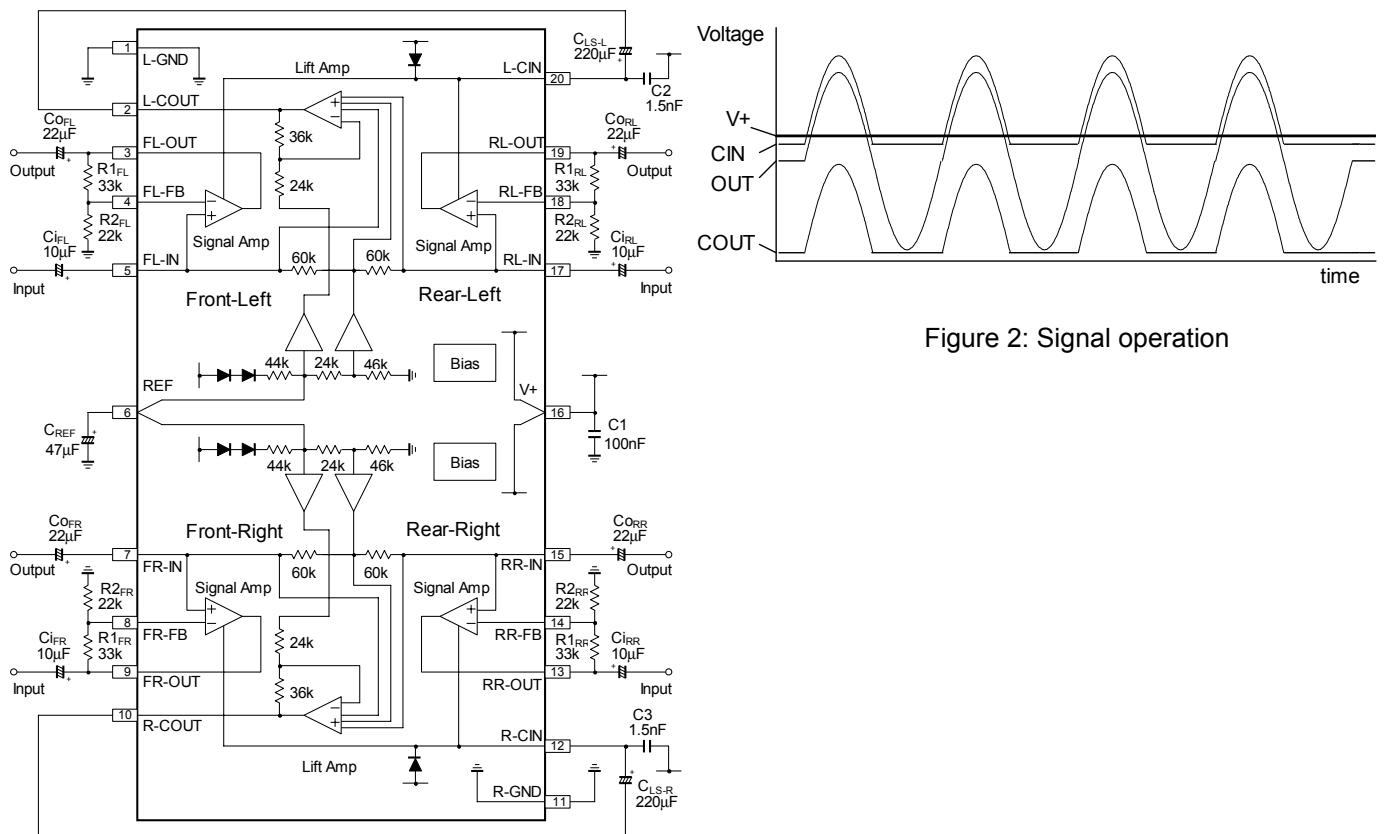

Figure 1: Block diagram and application circuit

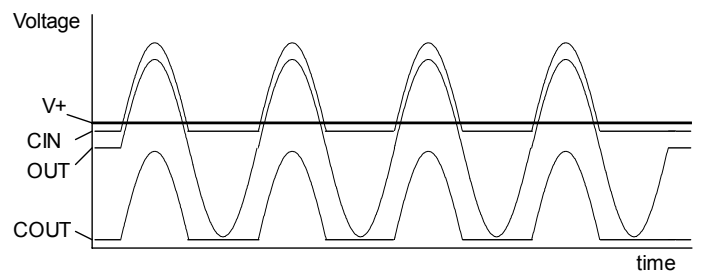

Figure 2: Signal operation

## ● OPERATING PRECAUTIONS

### 1. External parts

#### 1.1 Bypass capacitor for power supply

Bypass capacitor (C1) for the power supply should use the capacitor of wide temperature range and high-frequency characteristic. Connect the capacitor near the IC for low interconnection resistance.

#### 1.2 Feedback resistor

Set the gain to 8dB with feedback resistor R1 and R2 of each channel. The use of high-value resistors causes increase of the output noise voltage. However, R1+R2 cannot use low-value resistors because of the load resistance of the signal amplifier. The resistances of the example of application circuit are the recommend value.

#### 1.3 Input coupling capacitor

The low frequency of the input signal is cut with the high-pass filter that composes of input coupling capacitor and input impedance (about 60k $\Omega$ ). The cut-off frequency at capacitor value (10 $\mu$ F) of application circuit is about 0.3Hz.

#### 1.4 Output coupling capacitor

The low frequency of the output signal is cut with the high-pass filter that composes of output coupling capacitor (Co) and load resistance. The cut-off frequency lowers when the large capacitor value (Co). When the load resistance is 10k $\Omega$ , the cut-off frequency of application circuit is about 0.8Hz.

#### 1.5 Bypass capacitor for reference voltage

The bypass capacitor (C<sub>REF</sub>) for the reference voltage influences the turn-on time and SVR. When C<sub>REF</sub> is large, SVR is improved, but turn on time becomes long.

#### 1.6 Boost capacitor

When the boost capacitor (C<sub>Lift</sub>) is large, the distortion of the low frequency decreases.

#### 1.7 Bypass capacitor for CIN terminal

Bypass capacitor (C2/C3) of the CIN terminal absorbs fluctuation of the CIN terminal. The capacitances of the example of application circuit are the recommend value.

### 2. Load resistance

The NJM2792 is a line amplifier of class-A output. Connect the load resistance 10k $\Omega$  or more.

### 3. Amplifier gain

The amplifier gain of NJM2792 is decided in the ratio of external resistance R1 and R2. The output bias point of the signal amplifier changes when the gain is changed. The gain setting of +8dB is the recommend value.

### 4. Low frequency characteristic

The NJM2792 lifts the power-supply voltage of the signal amplifier by the lift amplifier. The electric power from the power supply is decided depending on external capacity (C<sub>Lift</sub>). Therefore, the distortion of low frequency increases when the electric power is insufficient. Connect capacitor (C<sub>Lift</sub>) of a large capacity value for the distortion decrease of a low frequency.



## 5. High frequency characteristic

The high frequency characteristic of NJM2792 can output 4.5Vrms(typ.) at 100kHz. However, note a capacitive load that increases at the high frequency. Set the total load impedance (load capacitance + load resistance) to 10kΩ or more if the flat high-frequency characteristic is necessary.

Maximum Output Voltage vs. Frequency  
(V+=9[V], THD=1[%], No-Filter, Ta=25°C)

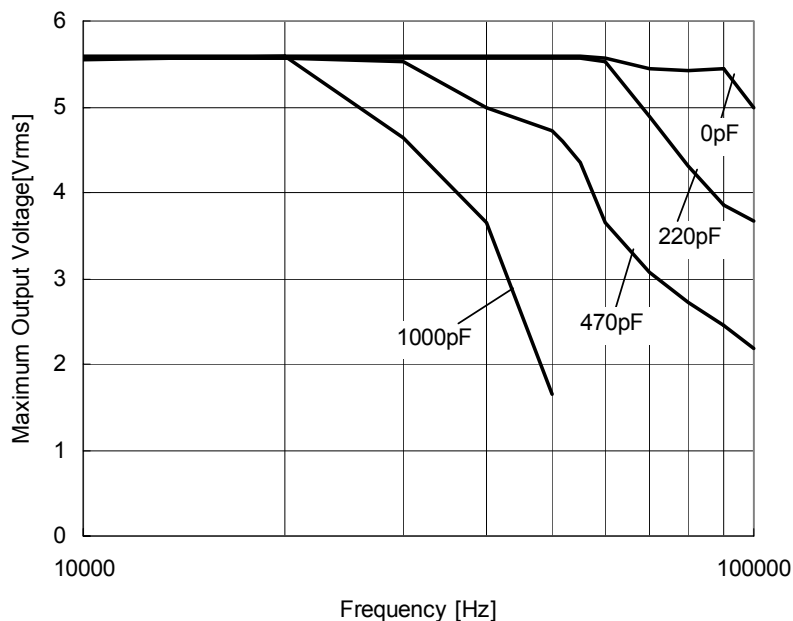

## 6. Signal phase to the front/rear channel

Input the in-phase signal to front/ rear channel of NJM2792. The reverse-phase signal input attenuates output signal amplitude. Input the signal different in only the signal level to front/rear channel.

Output Voltage vs. Phase Difference  
V+=9V, THD=0.1%, Ta=25°C

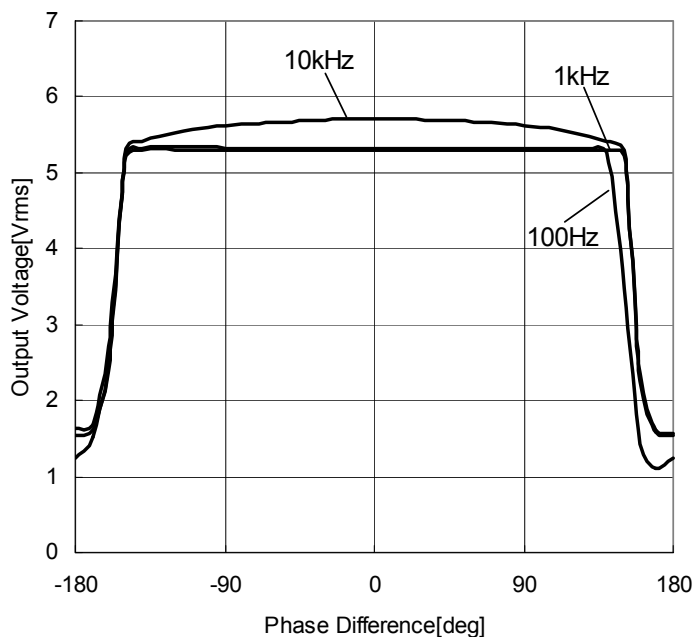

## 7. Turn on time

The NJM2792 application circuit connects the capacitance of 47 $\mu$ F with the reference voltage terminal. The signal amplitude is insufficient after turning on of the power supply by capacitor charge. The turn-on time is long at a large capacity value, and shortens at a small capacity value. Note the SVR characteristic when connecting small capacity value.

Waveform Rise Time

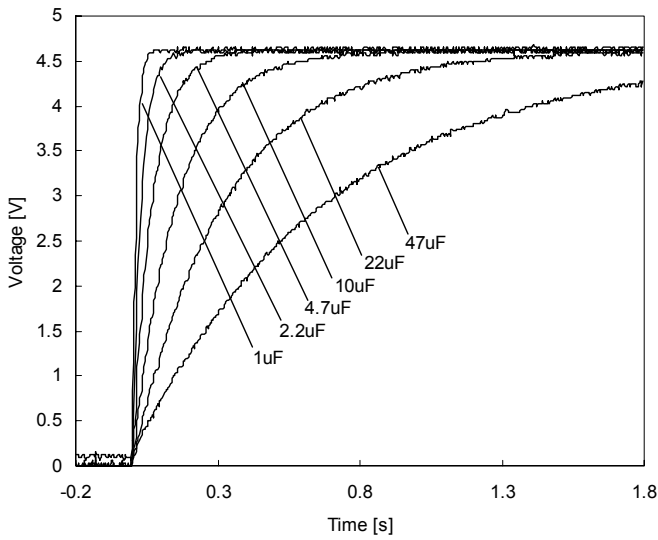

Rise Time vs Reference Voltage Capacity.  
Output voltage 90%

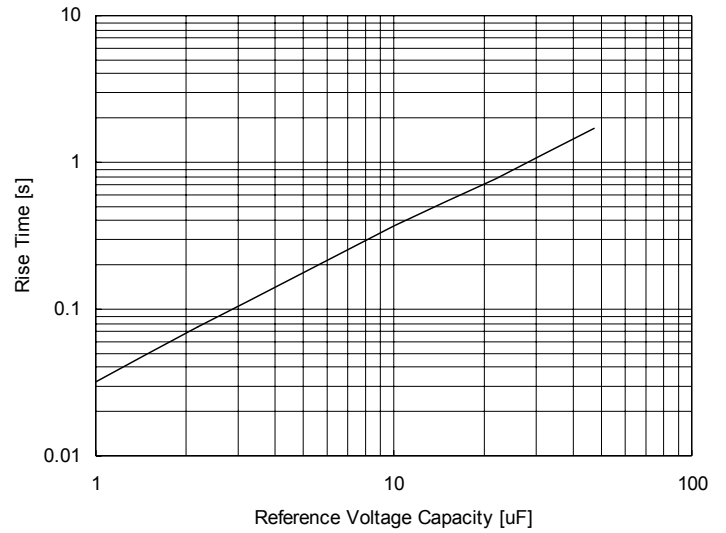

Power-supply Rejection Ratio vs. Frequency

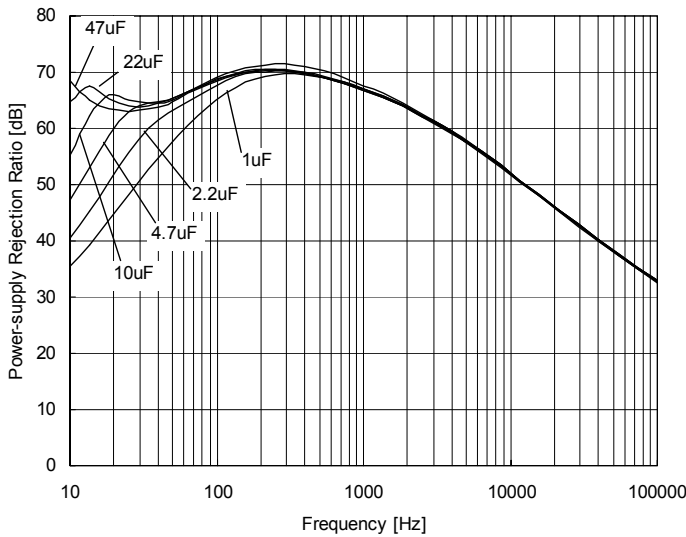

## ● 2-CHANNEL ONLY APPLICATION CIRCUIT

Use combination of front-left and front-right or rear-left and rear-right.

The reverse-phase signal input attenuates output signal amplitude. Input the signal different in only the signal level to front/rear channel.

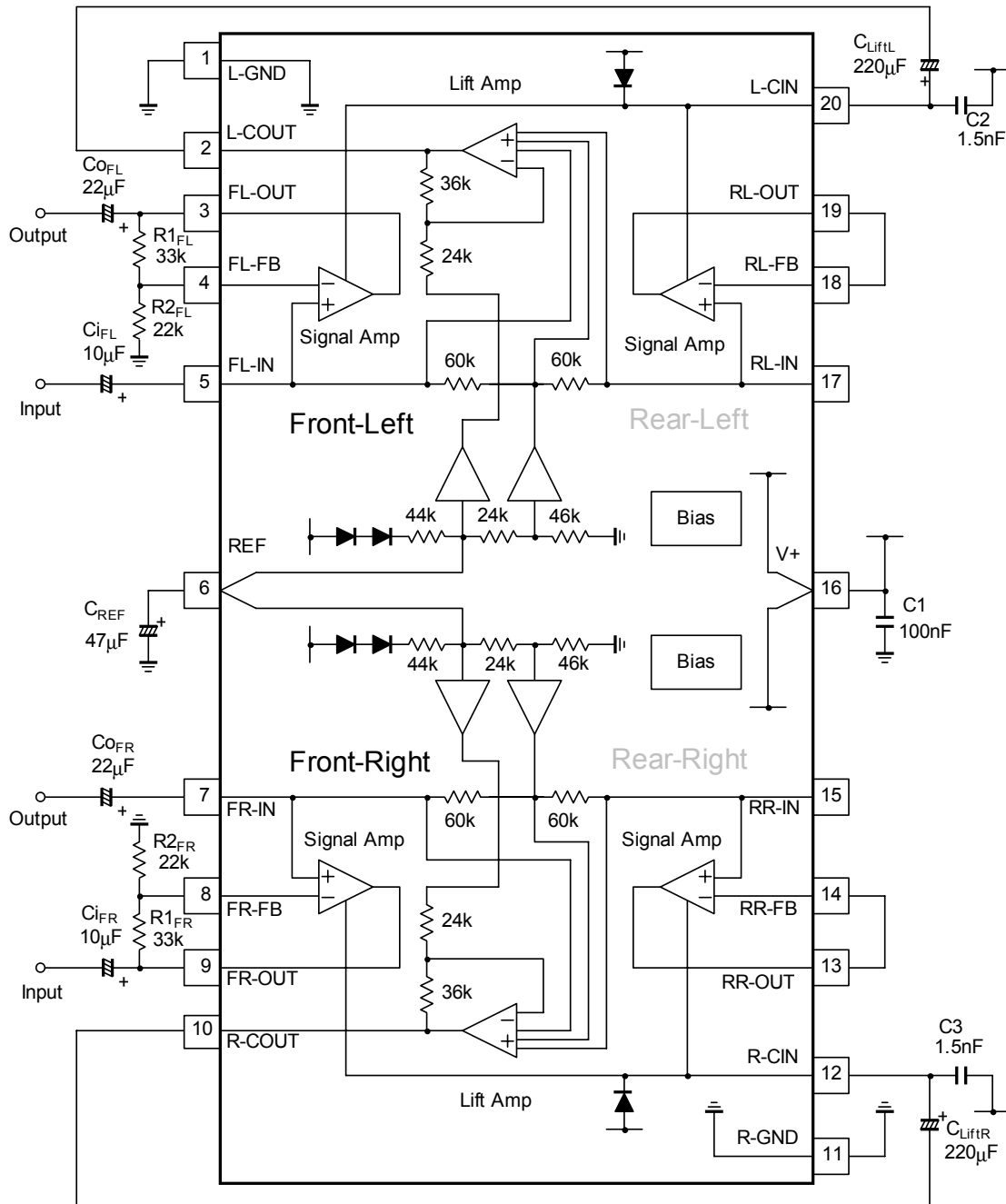

**The application note doesn't guarantee the characteristic.  
Give due consideration to characteristic variation of external parts and IC.**

## TYPICAL CHARACTERISTICS

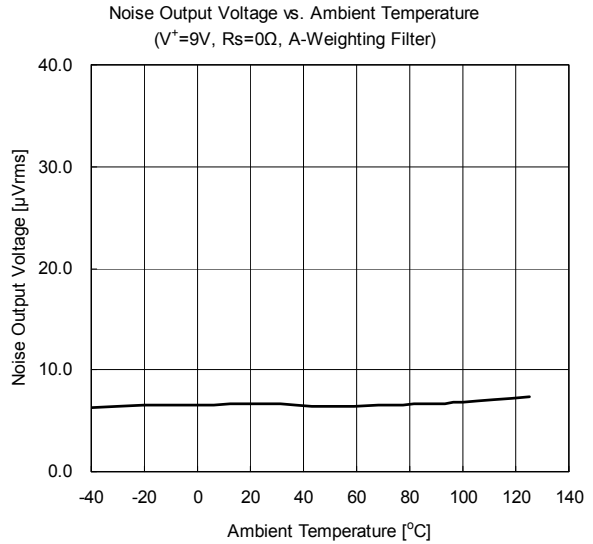
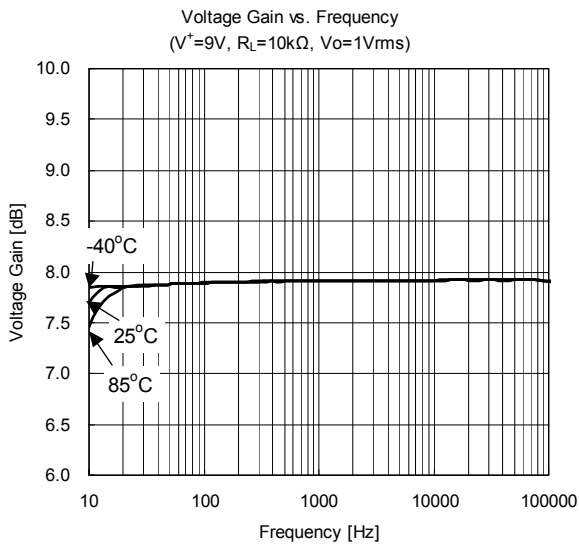
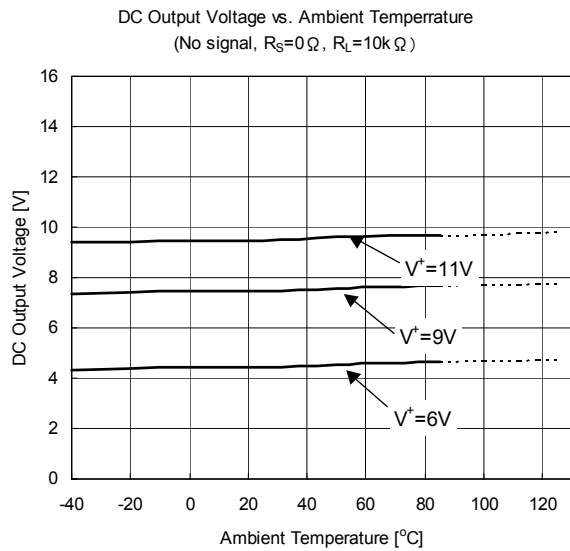
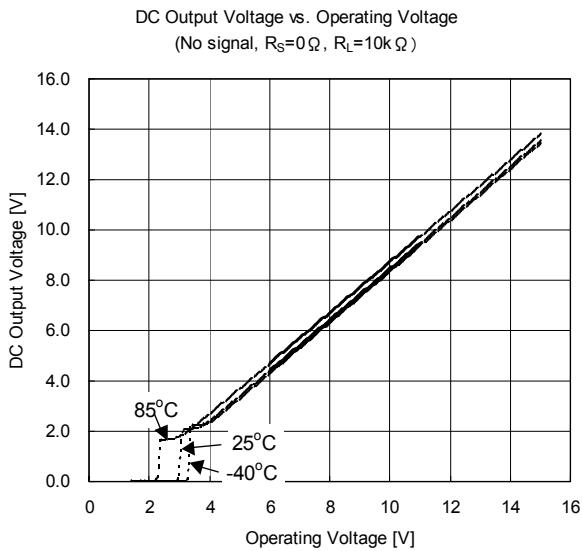
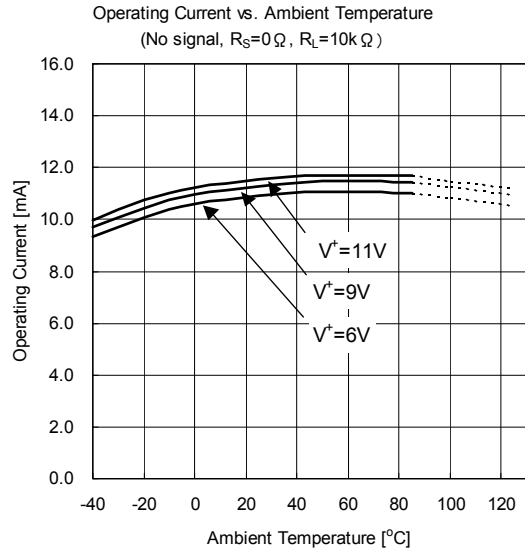
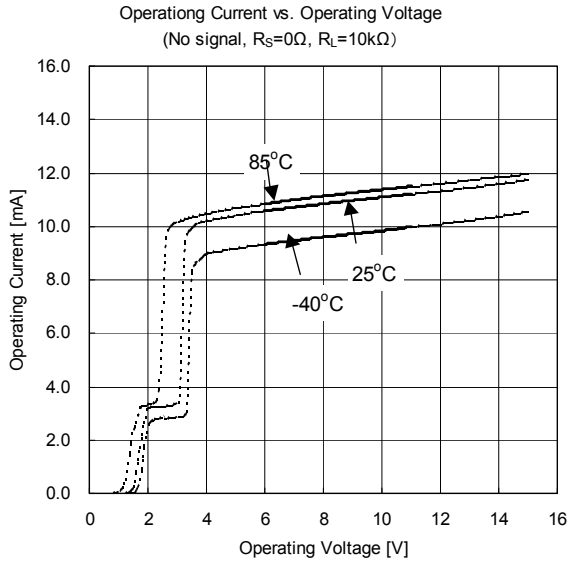

## TYPICAL CHARACTERISTICS

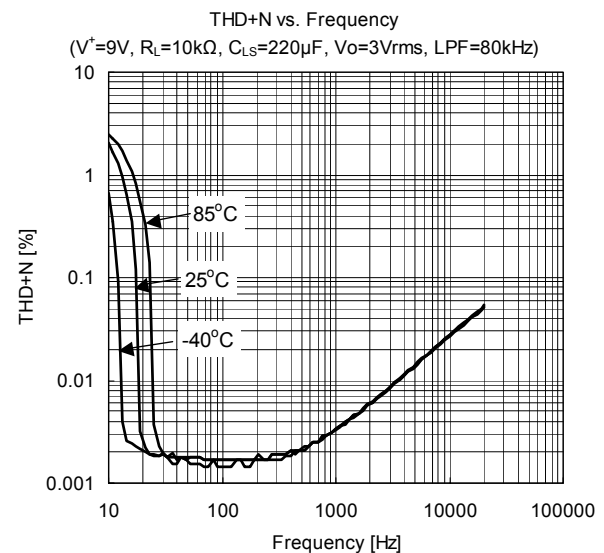
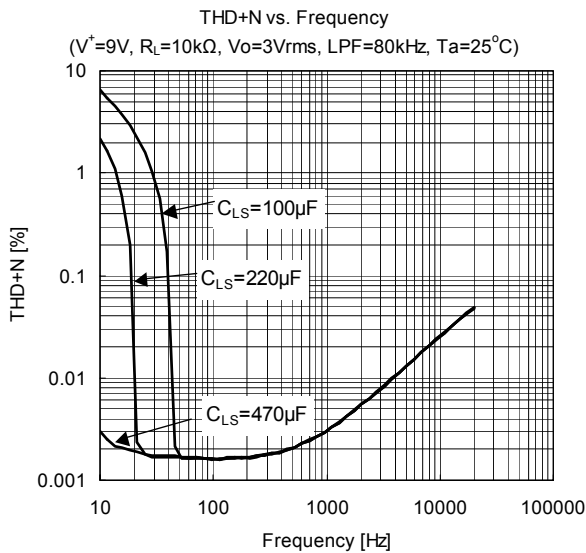
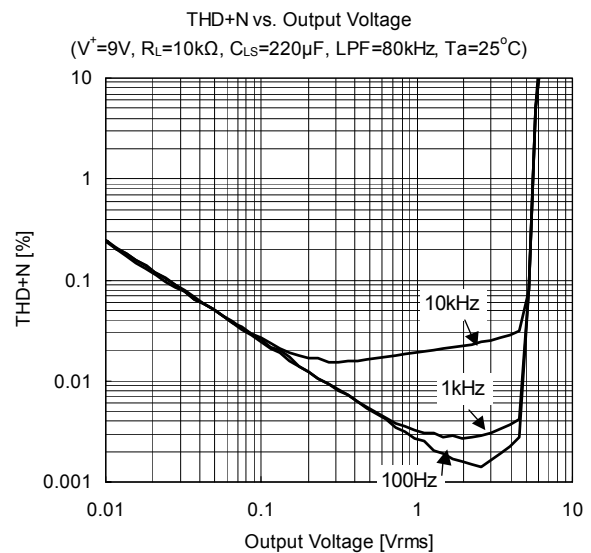
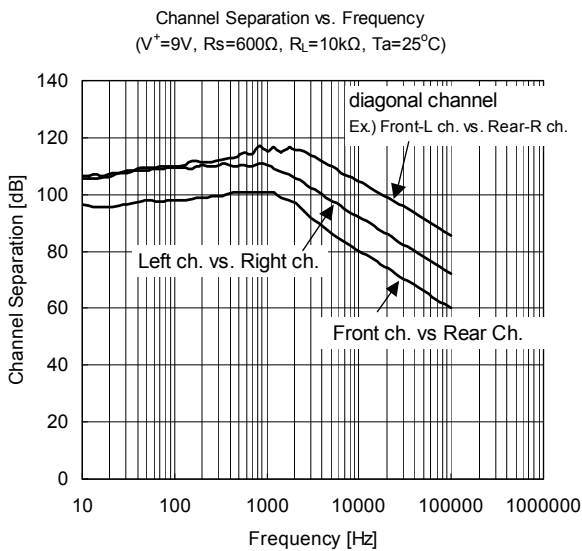
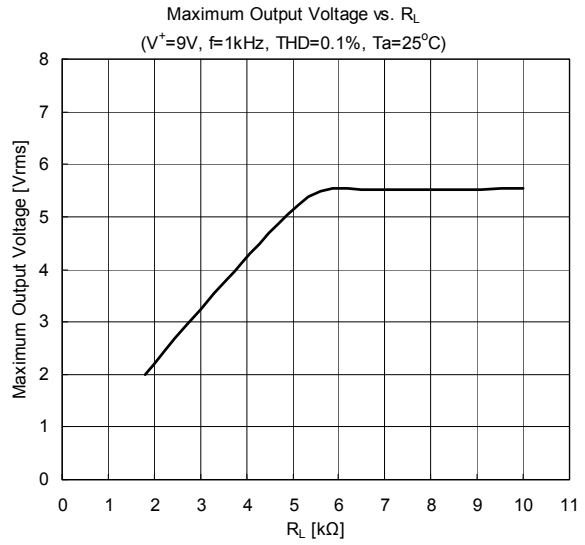
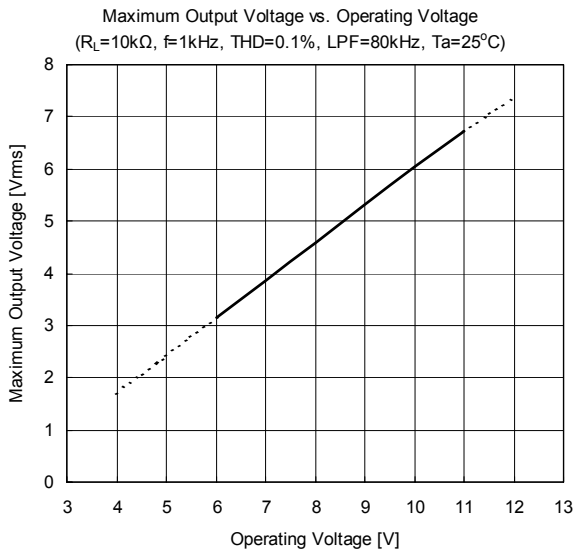

## ■ TYPICAL CHARACTERISTICS

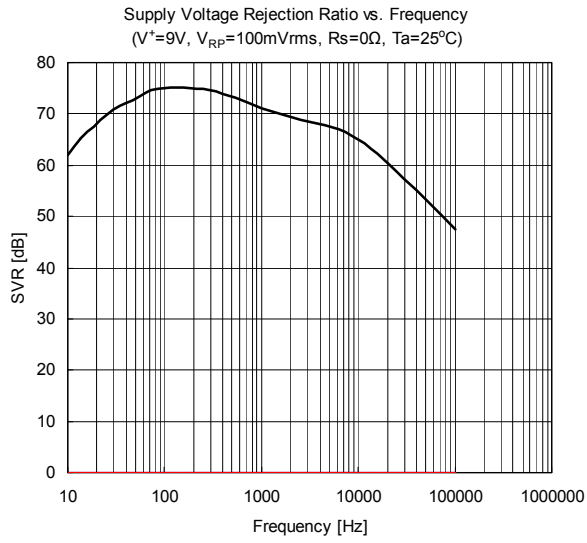

[CAUTION]  
The specifications on this databook are only given for information, without any guarantee as regards either mistakes or omissions. The application circuits in this databook are described only to show representative usages of the product and not intended for the guarantee or permission of any right including the industrial rights.