

REV.	DESCRIPTION	DATE
A	ISSUE	Dec/05/2013

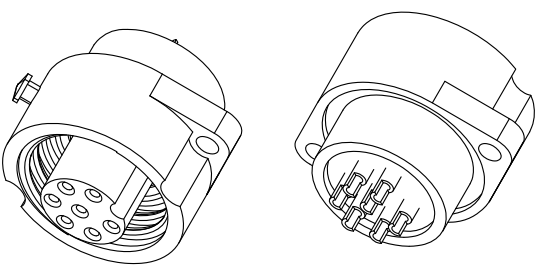

RoHS

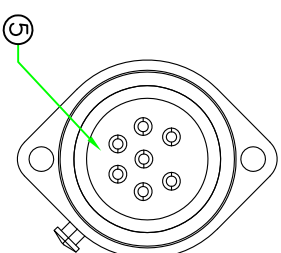
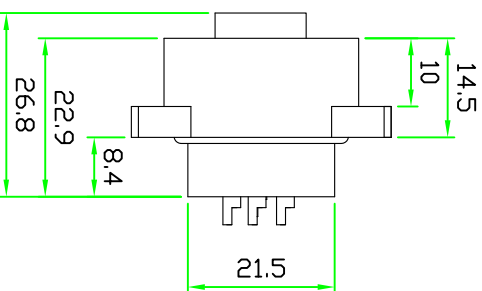
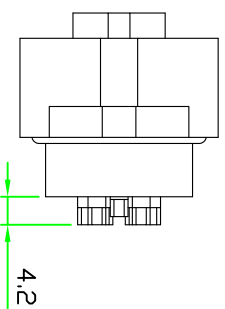
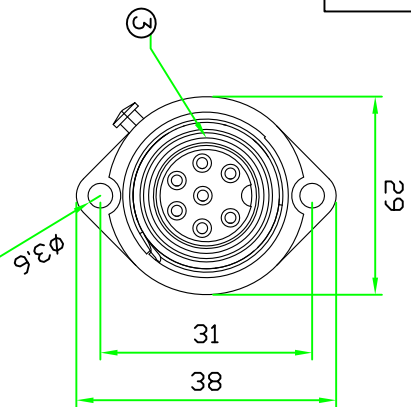
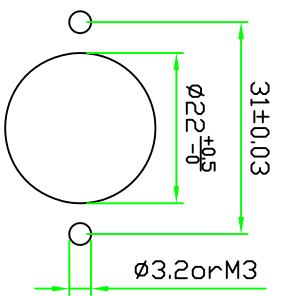
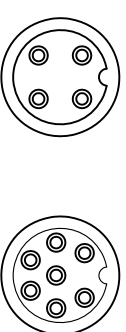
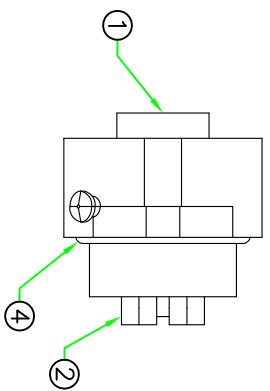
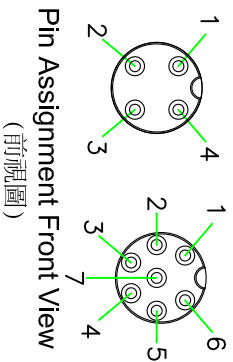

CPP-P204DSF CPP-P207DSF

5	GLUE	EPOXY.	BLACK	1		<b>HOLIN</b> ® HTP ASIA TECHNOLOGY CO., LTD. 禾凌科技股份有限公司 TITLE: CIRCULAR P SIZE FEMALE SOLDER PIN SCREW TYPE ROUND FLANGE SCREW MOUNT PANEL CONNECTOR P/N: CPP-P20xxDSF DR: JACK CH: MICHAEL AP:					
4	O-RING	NBR.	BLACK	1	O-1620-EK						
3	O-RING	NBR.	BLACK	1	O16-F-P-N						
2	CONTACT	BRASS, FEMALE PIN, 6u" GOLD PLATED.		N	F1.5SPL24.5						
1	CONNECTOR	NYLON+GF.	BLACK	1	CPP-P2xxC						
No.	PART NAME	DESCRIPTION			COLOR	Q'TY	REMARKS	SCALE	UNIT: mm	DWG. NO:	CPP-P20xxDSF
UNLESS OTHERWISE SPECIFIED TOLERANCES: X ±0.25 XX ±0.1 XXX ±0.05 ANGLE ±1° REV. A SHEET 1/1											