

SOT-23 Plastic-Encapsulate Transistors

FEATURES

- Ideally suited for automatic insertion
- For Switching and AF Amplifier Applications

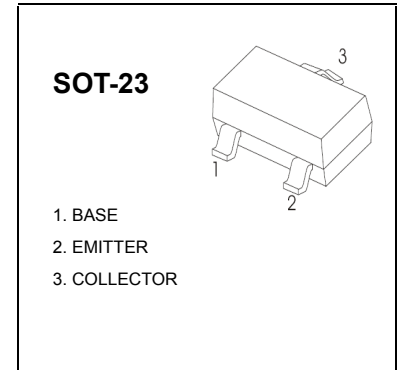

MAXIMUM RATINGS (T_a=25°C unless otherwise noted)

Symbol	Parameter	Value	Unit
V_{CBO}	Collector-Base Voltage		
	TKBC856	-80	V
	TKBC857	-50	
TKBC858	-30		
V_{CEO}	Collector-Emitter Voltage		
	TKBC856	-65	V
	TKBC857	-45	
TKBC858	-30		
V_{EBO}	Emitter-Base Voltage	-5	V
I_C	Collector Current –Continuous	-0.1	A
P_C	Collector Power Dissipation	200	mW
$R_{\theta JA}$	Thermal Resistance From Junction To Ambient	625	°C/W
T_J	Junction Temperature	150	°C
T_{stg}	Storage Temperature	-65~+150	°C

DEVICE MARKING

TKBC856A=3A;TKBC856B=3B;
TKBC857A=3E;TKBC857B=3F;TKBC857C=3G;
TKBC858A=3J; TKBC858B=3K; TKBC858C=3L

Parameter	Symbol	Test conditions	Min	Max	Unit
Collector-base breakdown voltage	TKBC856	$I_C = -10\mu A, I_E = 0$	-80		V
	TKBC857		-50		
	TKBC858		-30		
Collector-emitter breakdown voltage	TKBC856	$I_C = -10mA, I_B = 0$	-65		V
	TKBC857		-45		
	TKBC858		-30		
Emitter-base breakdown voltage	V_{EBO}	$I_E = -1\mu A, I_C = 0$	-5		V
Collector cut-off current	TKBC856	I_{CBO}	$V_{CB} = -70V, I_E = 0$		μA
	TKBC857		$V_{CB} = -45V, I_E = 0$	-0.1	
	TKBC858		$V_{CB} = -25V, I_E = 0$		
Emitter cut-off current	I_{EBO}	$V_{EB} = -5V, I_C = 0$		-0.1	μA
DC current gain	TKBC856A, 857A, 858A	$V_{CE} = -5V, I_C = -2mA$	125	250	
	TKBC856B, 857B, 858B		220	475	
	TKBC857C, TKBC858C		420	800	
Collector-emitter saturation voltage	$V_{CE(sat)}$	$I_C = -100mA, I_B = -5mA$		-0.5	V
Base-emitter saturation voltage	$V_{BE(sat)}$	$I_C = -100mA, I_B = -5mA$		-1.1	V
Transition frequency	f_T	$V_{CE} = -5V, I_C = -10mA$ $f = 100MHz$	100		MHz
Collector capacitance	C_{ob}	$V_{CB} = -10V, f = 1MHz$		4.5	pF

Static Characteristic

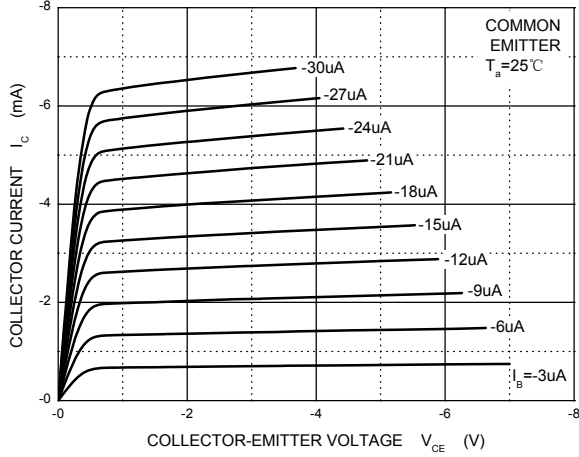

h_{FE} — I_c

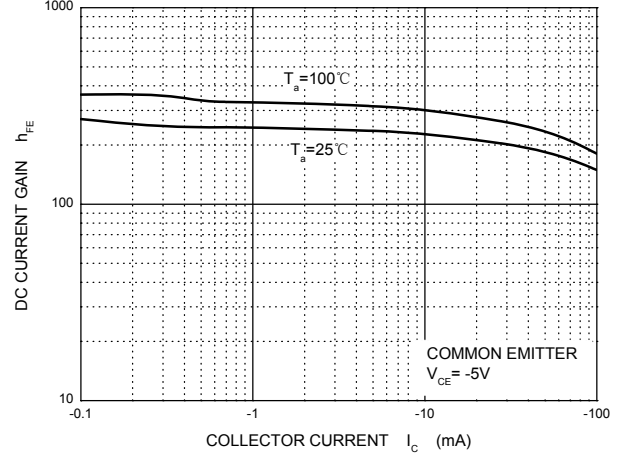

V_{CEsat} — I_c

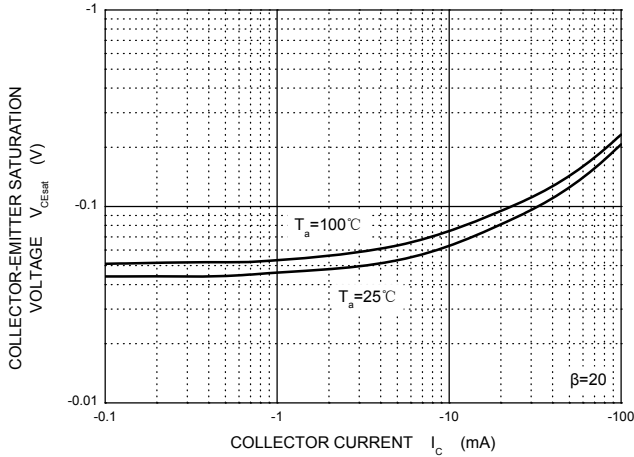

V_{BEsat} — I_c

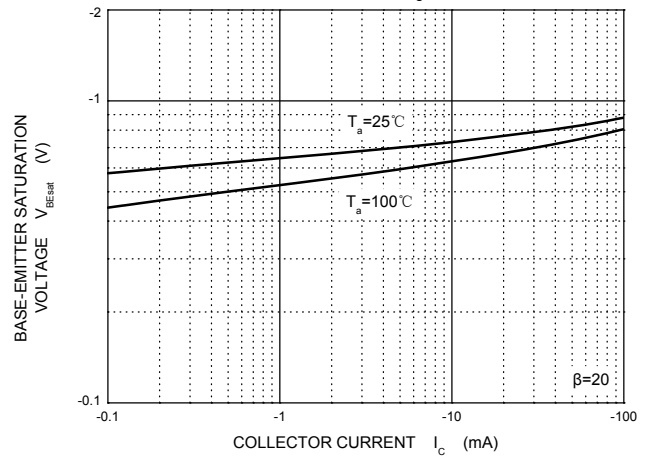

I_c — V_{BE}

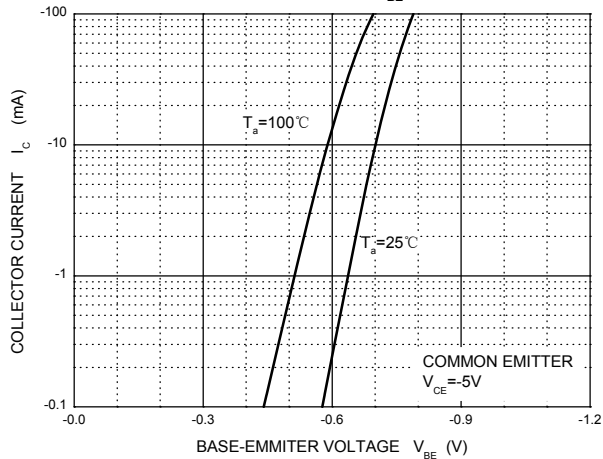

f_T — I_c

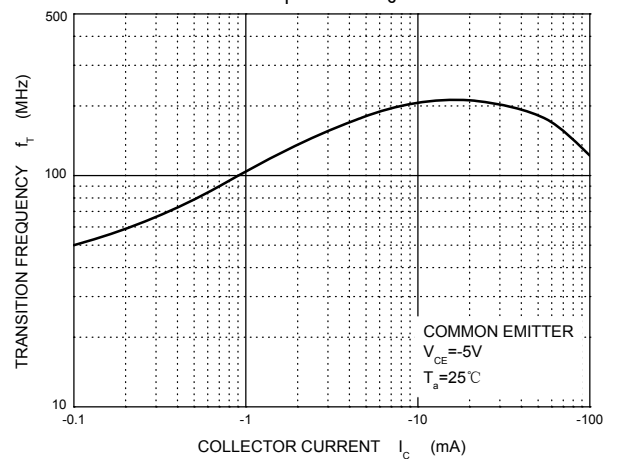

C_{ob}/C_{ib} — V_{CB}/V_{EB}

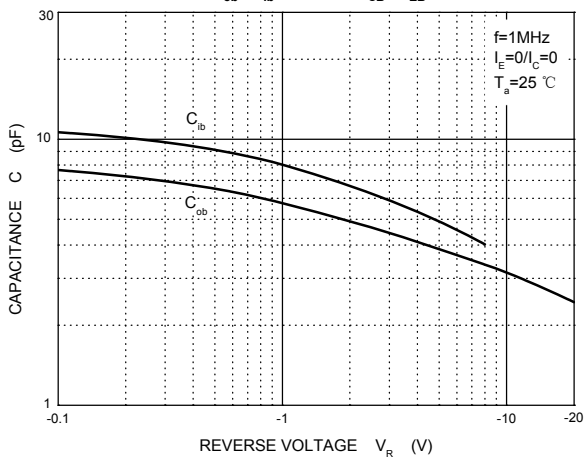

P_c — T_a

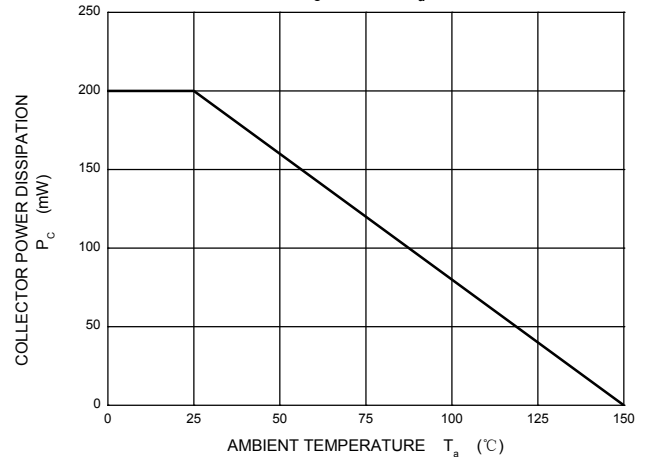

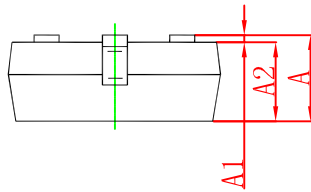
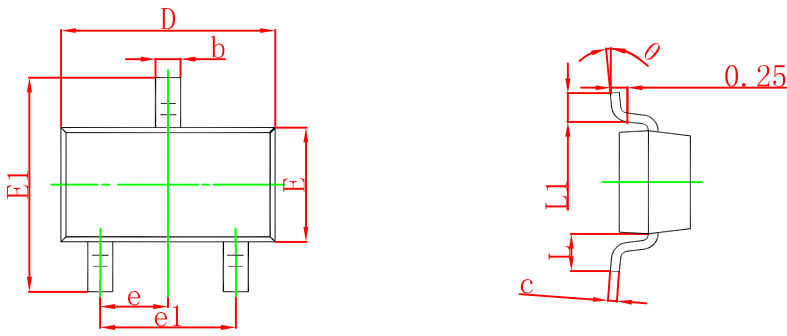

Symbol	Dimensions In Millimeters		Dimensions In Inches	
	Min	Max	Min	Max
A	0.900	1.150	0.035	0.045
A1	0.000	0.100	0.000	0.004
A2	0.900	1.050	0.035	0.041
b	0.300	0.500	0.012	0.020
c	0.080	0.150	0.003	0.006
D	2.800	3.000	0.110	0.118
E	1.200	1.400	0.047	0.055
E1	2.250	2.550	0.089	0.100
e	0.950 TYP		0.037 TYP	
e1	1.800	2.000	0.071	0.079
L	0.550 REF		0.022 REF	
L1	0.300	0.500	0.012	0.020
θ	0°	8°	0°	8°

SOT-23 Suggested Pad Layout

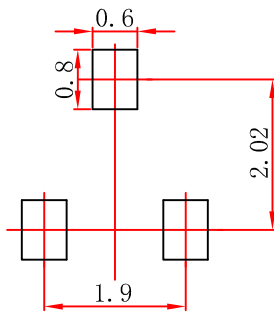

- Note:
1. Controlling dimension: in millimeters.
 2. General tolerance: $\pm 0.05\text{mm}$.
 3. The pad layout is for reference purposes only.