

RECOMMENDED  
PANEL CUT OUT

**RoHS**  
**IP66~68**

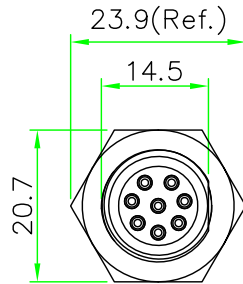

P/N NO.	D
CBP	∅1.25
CBD	∅1.0
CBN	∅0.8

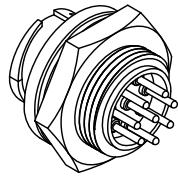
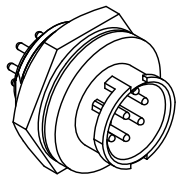
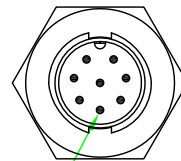
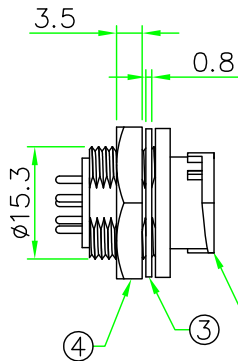
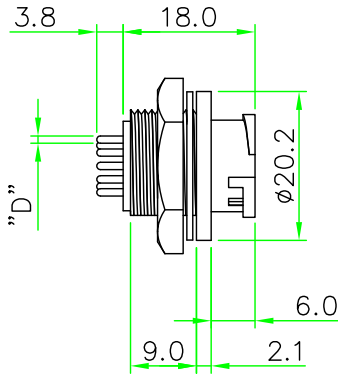

REV.	DESCRIPTION	DATE
A	ISSUE	Jul/16/2014

NOTES:

1. ELECTRICAL CHARACTERISTICS:

CURRENT RATING: 2A / 5A / 10A

CONNECTOR TEMPERATURE RANGE: -40°C TO +105°C

DIELECTRIC WITHSTANDING VOLTAGE:

500V AC FOR ONE MINUTE

2. HOW TO ORDER: CBx-L1xxCPF

- 02 - 2 PIN 07 - 7 PIN
- 03 - 3 PIN 08 - 8 PIN
- 04 - 4 PIN 10 - 10 PIN
- 05 - 5 PIN 12 - 12 PIN
- 06 - 6 PIN

- P - CURRENT RATING 10A
- D - CURRENT RATING 5A
- N - CURRENT RATING 2A

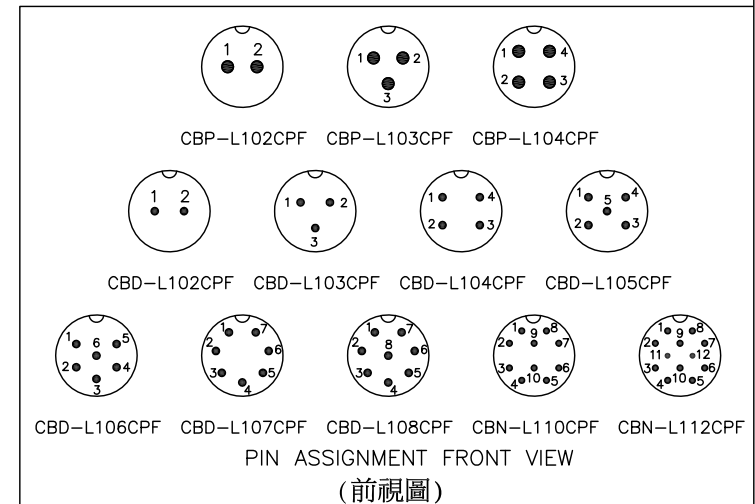

**HOLIN**® HTP ASIA TECHNOLOGY CO., LTD.  
禾凌科技股份有限公司

	UNIT: mm	TITLE : Circular B Size Male Connector Male Pin Lock Type Round Flange Front Panel Mount PCB Pin
	SCALE 1:1	
UNLESS OTHERWISE SPECIFIED TOLERANCES: .x ± 0.25 .xx ± 0.1 .xxx ± 0.05 ANGLE ± 1°		P/N: CBx-L1xxCPF DWG.NO: CBx-L1xxCPF
REV. A	SHEET 1/2	

4	HEX NUT	NYLON+GF.	BLACK	1	
3	GASKET	EPDM.	BLACK	1	
2	CONTACT	Brass , 6 u" Gold Plated . Male Contact.		N	
1	CONNECTOR	B Size Male Connector Insert.NYLON+GF.	BLACK	1	
No.	PART NAME	DESCRIPTION	COLOR	Q'TY	REMARKS

REV.	DESCRIPTION	DATE
A	ISSUE	Jul/15/2014

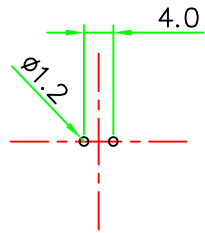

CBD-L102CPF

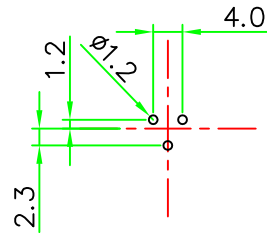

CBD-L103CPF

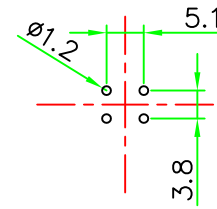

CBD-L104CPF

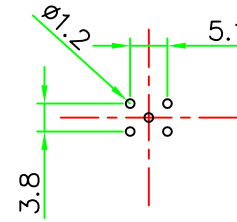

CBD-L105CPF

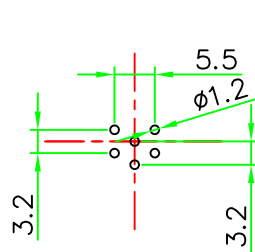

CBD-L106CPF

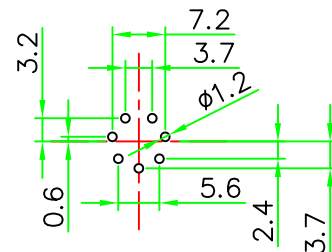

CBD-L107CPF

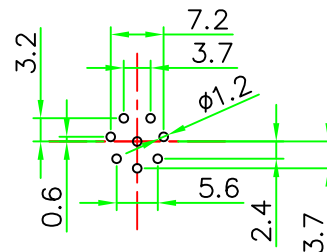

CBD-L108CPF

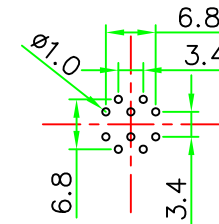

CBN-L110CPF

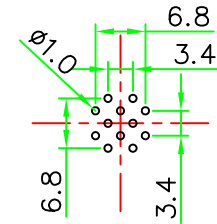

CBN-L112CPF

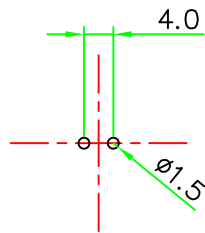

CBP-L102CPF

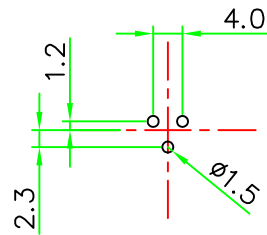

CBP-L103CPF

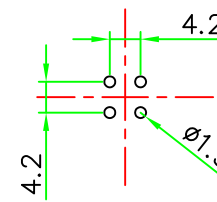

CBP-L104CPF

**HOLIN**® HTP ASIA TECHNOLOGY CO., LTD.  
禾凌科技股份有限公司

		UNIT: mm	TITLE : Circular B Size Male Connector Male Pin Lock Type Round Flange Front Panel Mount PCB Pin	
SCALE	1:1	P/N: CBx-L1xxCPF		DR. Patty
UNLESS OTHERWISE SPECIFIED TOLERANCES: .x ± 0.25 .xx ± 0.1 .xxx ± 0.05 ANGLE ± 1°		DWG.NO: CBx-L1xxCPF		CH. ERIC
REV. A	SHEET 2/2			AP.