



# LITHIUM THIONYL CHLORIDE BATTERY

## 锂亚硫酰氯电池 | 型号: ER17505M

### Characteristics 性能数据

Nominal capacity(1.0mA-2.0v).....	2700mAh
标称容量	
Nominal voltage.....	3.6v
额定电压	
Max.constant current.....	1000mA
最大连续工作电流	
Max.pulse current.....	2000mA
最大脉冲电流	
Weight.....	29g
电池重量	
Volume.....	Φ 17.5X50.5mm
电池尺寸	
Workable temperature.....	-55℃~+85℃
工作温度	

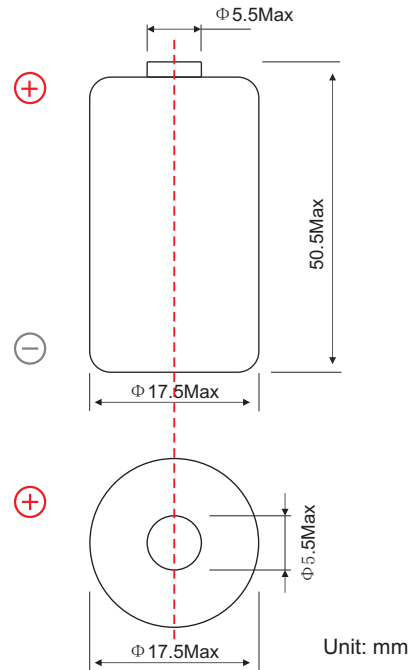

### Discharge characteristic 放电特性 (25℃)

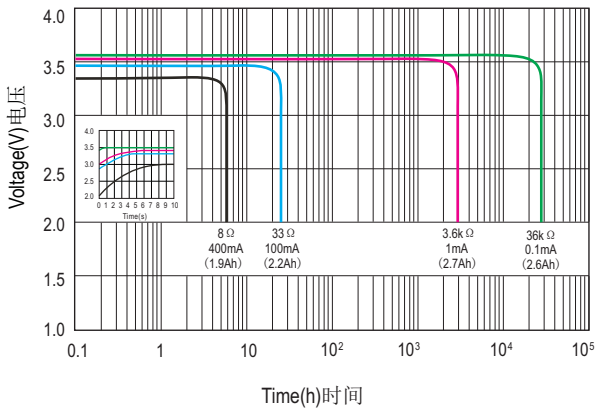

### Voltage vs temperature 电压vs温度

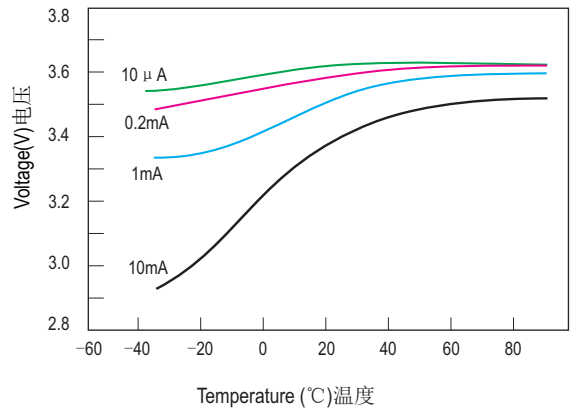

### Capacity vs current 容量vs电流

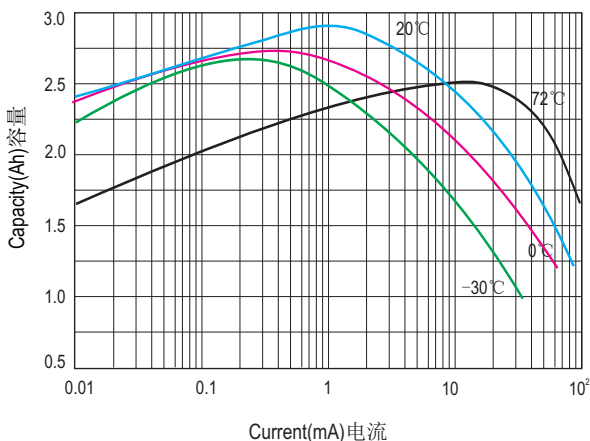

### Storage characteristics 存储特性

