

Female Terminal

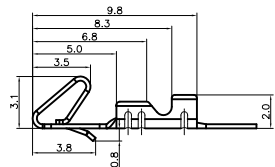

Female Terminal

Wire Range		O.D of Wire
Section Area (mm <sup>2</sup> )	AWG#	mm
0.2~0.75	28~18	1.2~2.1



Female Housing

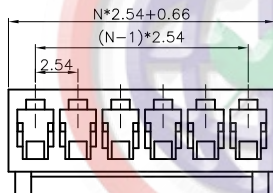
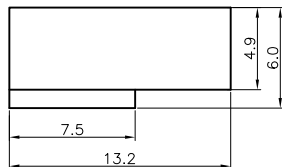

Male Right Angle

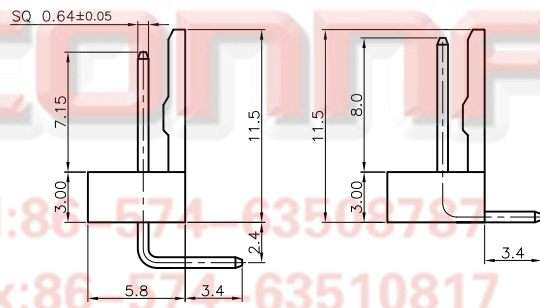
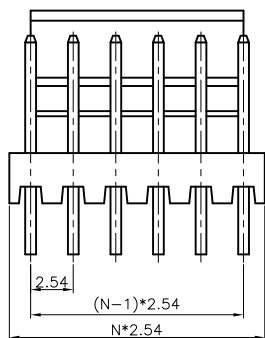

Type A

Type B

Male V/T TYPE

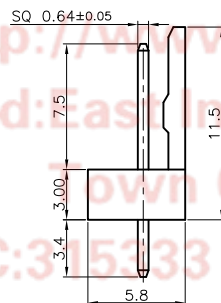
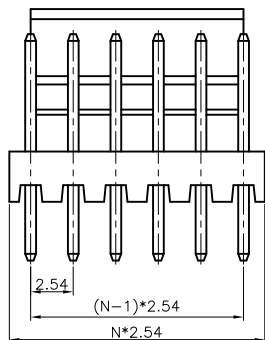

N=NO. OF CONTACTS

REV.	DESCRIPTION	DRAWN	CHECKED	APPROVED
A	NEW RELEASE	YCH 06/27/08'	~	LJC 06/27/08'
B	DRAWING UPDATE	JLZ 08/30/16'	HZW 08/30/16'	LJC 08/30/16'
C	DRAWING UPDATE	JLZ 10/08/16'	~	

NOTES:

1. MAIN SPECIFICATIONS

- . Housing material: NYLON 66
- . Contact material: Copper alloy
- . Rated voltage: 250V
- . Rated current: 3A
- . Contact resistance: ≤ 30mΩ
- . Insulation resistance: ≥ 1000MΩ
- . Withstanding voltage: 500V,AC 1 minute
- . Temperature range: -25 ~ +85°C

2. PRODUCT NUMBER CODE:

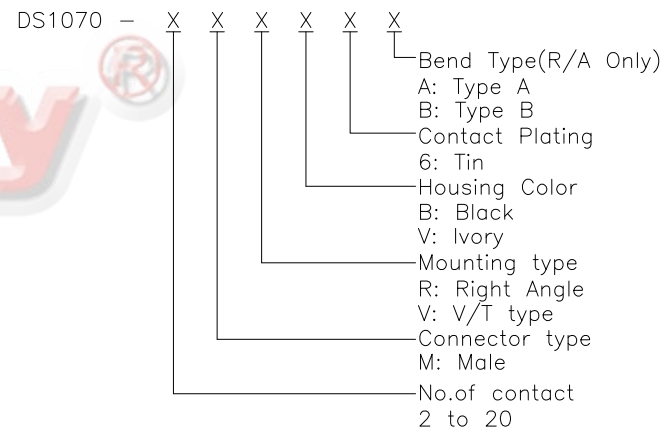

Female Housing:

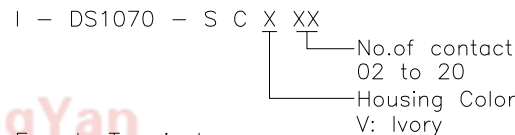

Female Terminal:

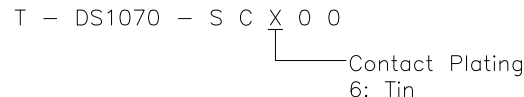

GENERAL TOLERANCE		ANGLE TOLERANCE		PROJECTION	TITLE
X.	±0.60	X.	±5°	mm	P.C.B CONNECTOR Pitch 2.54mm
.X	±0.38	.X	±3°	A4	SERIES DS1070
.XX	±0.25	.XX	±2°		
DRAWING TYPE		CUSTOMER		晨翔电子有限公司 <b>CONNFLY CONNFLY ELECTRONIC CO., LTD</b>	
SCALE		1:1 SHEET 1 OF 1			
DRAWING NO.		C-DS1070-XXXXXX-C			