

SOT-23 Plastic-Encapsulate Transistors

FEATURES

- Epitaxial planar die construction
- Complementary NPN Type available(TKMMBT2222A)

Marking: 2F

MAXIMUM RATINGS (Ta=25°C unless otherwise noted)

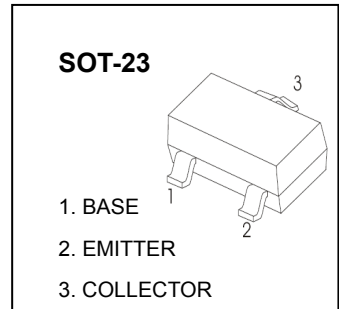

Symbol	Parameter	Value	Unit
V _{CB0}	Collector-Base Voltage	-60	V
V _{CE0}	Collector-Emitter Voltage	-60	V
V _{EBO}	Emitter-Base Voltage	-5	V
I _C	Collector Current -Continuous	-600	mA
P _D	Total Device Dissipation	250	mW
R _{θJA}	Thermal Resistance Junction to Ambient	500	°C/W
T _J	Junction Temperature	150	
T _{stg}	Storage Temperature	-55 to +150	

ELECTRICAL CHARACTERISTICS (Ta=25°C unless otherwise specified)

Parameter	Symbol	Test conditions	Min	Typ	Max	Unit
Collector-base breakdown voltage	V _{(BR)CBO}	I _C =-10μA, I _E =0	-60			V
Collector-emitter breakdown voltage	V _{(BR)CEO*}	I _C =-10mA, I _B =0	-60			V
Emitter-base breakdown voltage	V _{(BR)EBO}	I _E =-10μA, I _C =0	-5			V
Collector cut-off current	I _{CBO}	V _{CB} =-50V, I _E =0			-20	nA
Base cut-off current	I _{EBO}	V _{EB} =-3V, I _C =0			-10	nA
Collector cut-off current	I _{CEX}	V _{CE} =-30 V, V _{BE(off)} =-0.5V			-50	nA
DC current gain	h _{FE(1)}	V _{CE} =-10V, I _C =-150mA	100		300	
	h _{FE(2)}	V _{CE} =-10V, I _C =-0.1mA	75			
	h _{FE(3)}	V _{CE} =-10V, I _C =-1mA	100			
	h _{FE(4)}	V _{CE} =-10V, I _C =-10mA	100			
	h _{FE(5)}	V _{CE} =-10V, I _C =-500mA	50			
Collector-emitter saturation voltage	V _{CE(sat)*}	I _C =-150mA, I _B =-15mA			-0.4	V
	V _{CE(sat)*}	I _C =-500mA, I _B =-50mA			-1.6	V
Base-emitter saturation voltage	V _{BE(sat)*}	I _C =-150mA, I _B =-15mA			-1.3	V
	V _{BE(sat)*}	I _C =-500mA, I _B =-50mA			-2.6	V
Transition frequency	f _T	V _{CE} =-20V, I _C =-50mA, f=100MHz	200			MHz
Delay time	t _d	V _{CE} =-30V, I _C =-150mA, I _{B1} =-15mA			10	ns
Rise time	t _r				25	ns
Storage time	t _s	V _{CE} =-6V, I _C =-150mA, I _{B1} =- I _{B2} =- 15mA			225	ns
Fall time	t _f				60	ns

*Pulse test: t_p≤300μs, δ≤0.02.

CLASSIFICATION OF h_{FE(1)}

RANGE	100 - 300
MARKING	2F

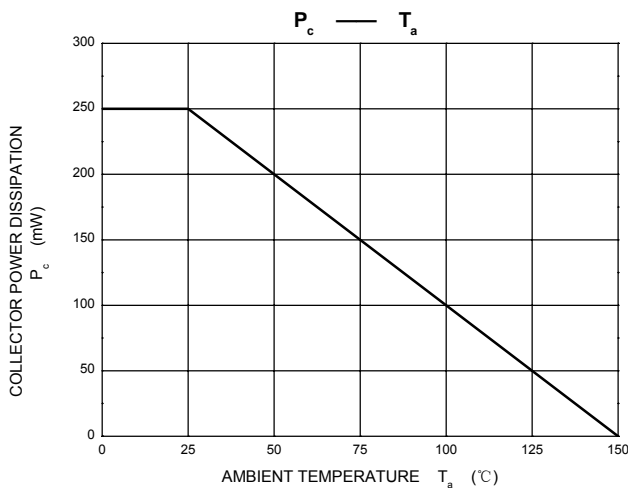
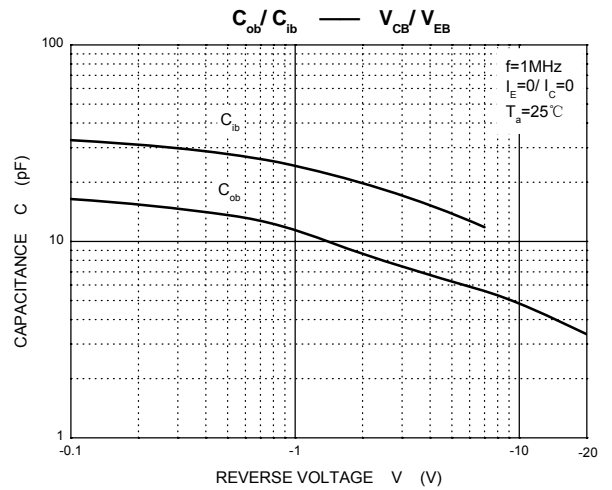
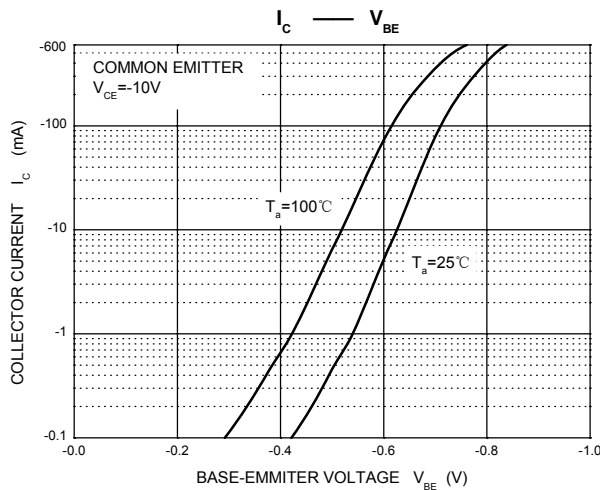
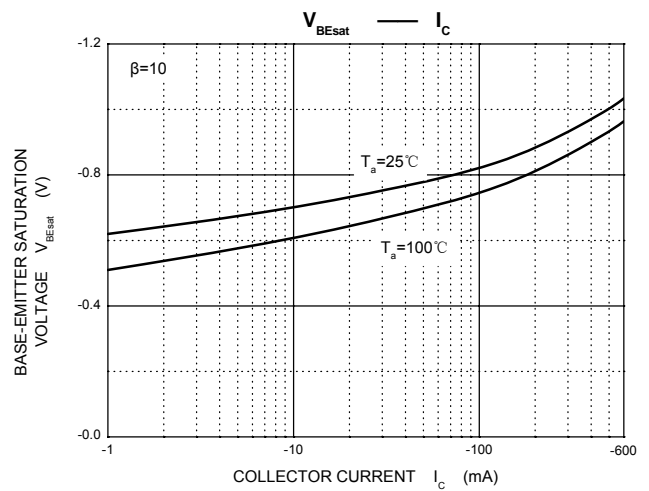
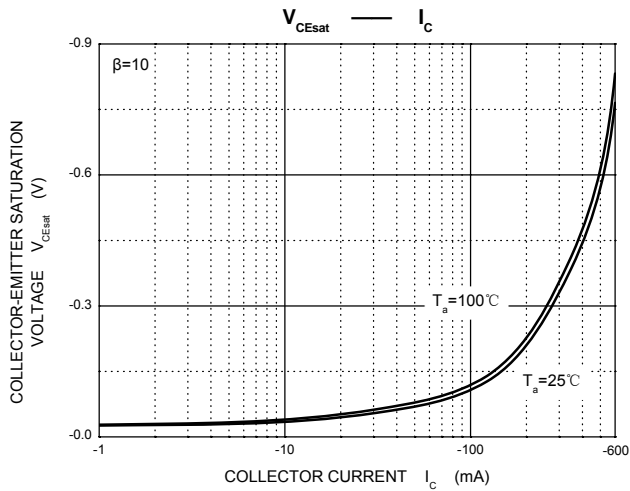
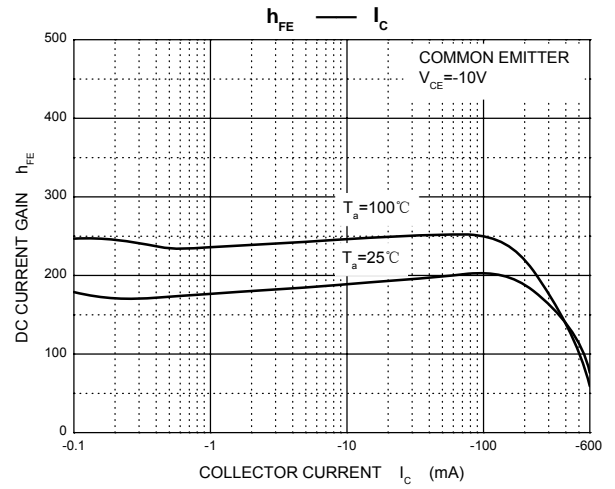
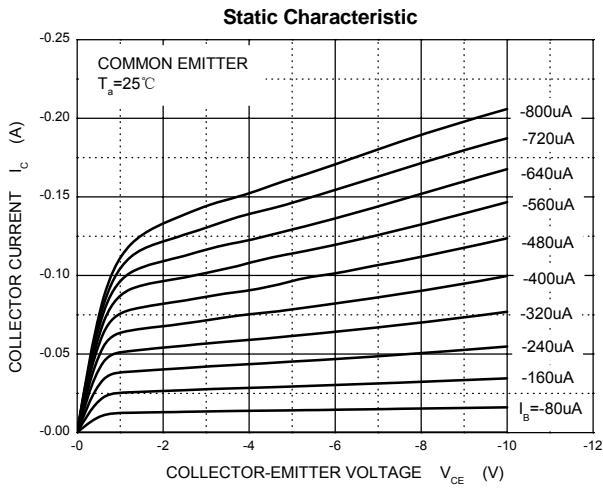

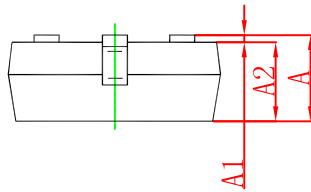
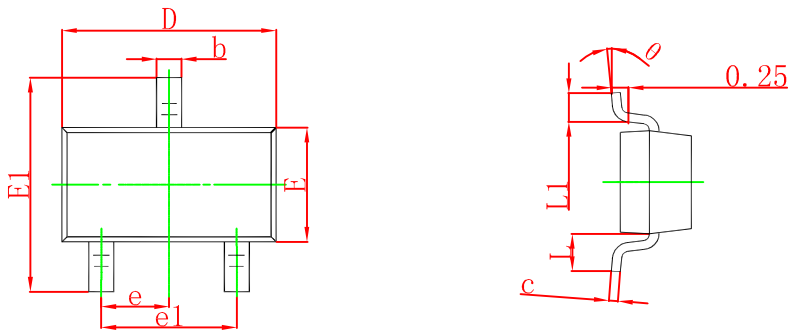

Symbol	Dimensions In Millimeters		Dimensions In Inches	
	Min	Max	Min	Max
A	0.900	1.150	0.035	0.045
A1	0.000	0.100	0.000	0.004
A2	0.900	1.050	0.035	0.041
b	0.300	0.500	0.012	0.020
c	0.080	0.150	0.003	0.006
D	2.800	3.000	0.110	0.118
E	1.200	1.400	0.047	0.055
E1	2.250	2.550	0.089	0.100
e	0.950 TYP		0.037 TYP	
e1	1.800	2.000	0.071	0.079
L	0.550 REF		0.022 REF	
L1	0.300	0.500	0.012	0.020
θ	0°	8°	0°	8°

SOT-23 Suggested Pad Layout

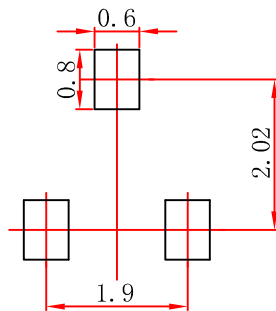

- Note:
1. Controlling dimension: in millimeters.
 2. General tolerance: $\pm 0.05\text{mm}$.
 3. The pad layout is for reference purposes only.