

## Biomonitoring Sensor with Red & IR LED

### FEATURES

- Peak wavelength :  $\lambda_p$  660nm (Red), 940nm (Infrared)
- Miniature, thin package: 2.4 X 3.75 X 0.8mm
- Pb free solder re-flowing permitted: 260°C, 2 times
- Pb free, Halogen free
- Conformity to RoHS directive

### GENERAL DESCRIPTION

NJL5510R is the compact surface mount type photo sensor, which is built in a RED LED, Infrared LED and a high sensitive photo diode. NJL5510R is a sensor for SpO<sub>2</sub>, pulse rate (heart rate) measurement which shows one of fitness application that targeted the fitness tracker like Smart watch/Band/Bracelet.

### APPLICATION

- Bio monitor as SpO<sub>2</sub>, pulse rate of Wearable Devices (Smart watch, Fitness Tracker etc.)
- Mobile Devices

### EQUIVALENT CIRCUIT - BLOCK DIAGRAM

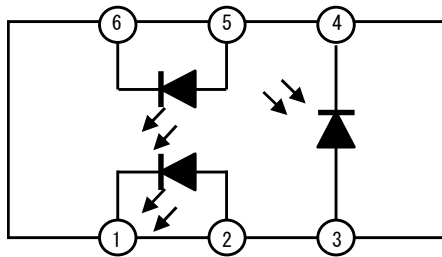

- |        |         |
|--------|---------|
| 1. LRK | 6. LIRK |
| 2. LRA | 5. LIRA |
| 3. PA  | 4. PK   |

### PIN CONFIGURATION

PIN NO.	SYMBOL	DESCRIPTION
1	LRK	Cathode for RED LED
2	LRA	Anode for RED LED
3	PA	Anode for PD
4	PK	Cathode for PD
5	LIRA	Anode for IR LED
6	LIRK	Cathode for IR LED

(Top View)

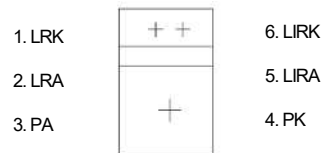

### ORDERING INFORMATION

PART NUMBER	PACKAGE OUTLINE	RoHS	HALOGEN-FREE	TERMINAL FINISH	MARKING	WEIGHT (mg)	MOQ(pcs)
NJL5510R	COBP	✓	✓	Au	No marking	12	3,000

## ■ABSOLUTE MAXIMUM RATINGS

PARAMETER	SYMBOL	RATINGS	UNIT
Emitter			
Forward Current (Continuous) <sup>*2</sup>	IF RED	50	mA
	IF IR	50	mA
Reverse Voltage (Continuous)	VR RED	5	V
	VR IR	5	V
Power Dissipation <sup>*1</sup>	PD	65	mW
Detector			
Reverse Voltage	VR	35	V
Power Dissipation	PD	20	mW
Coupled			
Total Power Dissipation	P <sub>tot</sub>	85	mW
Operating Temperature Range	T <sub>opr</sub>	-20 to +70	°C
Storage Temperature Range	T <sub>stg</sub>	-30 to +85	°C
Reflow Soldering Temperature	T <sub>sol</sub>	260	°C

\*1 Please do not be turned on the LEDs of different wavelength at the same time.

\*2 This is current value of each 1pcs LED.

## ■ELECTRO-OPTICAL CHARACTERISTICS (Ta=25 °C)

PARAMETER	SYMBOL	TEST CONDITION	MIN.	TYP.	MAX.	UNIT
Emitter						
DC Forward Voltage	V <sub>F</sub> RED	I <sub>F</sub> =10mA	—	1.9	2.2	V
	V <sub>F</sub> IR	I <sub>F</sub> =10mA	—	1.2	1.4	V
Pulse Forward Voltage *1	V <sub>FP</sub> RED	I <sub>FP</sub> =100mA	—	2.1	—	V
	V <sub>FP</sub> IR	I <sub>FP</sub> =100mA	—	1.4	—	V
Reverse Current	I <sub>R</sub> RED	V <sub>R</sub> =5V	—	—	10	μA
	I <sub>R</sub> IR	V <sub>R</sub> =5V	—	—	10	μA
Peak Wavelength *2	λ <sub>P</sub> RED	I <sub>F</sub> =10mA	656	660	664	nm
	λ <sub>P</sub> IR	I <sub>F</sub> =10mA	930	940	950	nm
Detector						
Dark Current	I <sub>D</sub>	V <sub>R</sub> =10V, Without incident light	—	0.1	2	nA
Forward Voltage	V <sub>F</sub>	I <sub>F</sub> =1mA, Without incident light	—	—	1.2	V
Terminal Capacitance	C <sub>t</sub>	V <sub>R</sub> =0V, f=1MHz	—	25	—	pF
		V <sub>R</sub> =2.5V, f=1MHz	—	12	—	pF
Peak Wavelength	λ <sub>p</sub>	V <sub>R</sub> =0V	—	800	—	nm
Coupled						
Output Current *3	I <sub>O</sub> RED	I <sub>F</sub> =4mA, V <sub>R</sub> =2.5V, d=2.0mm*5	2.5	—	8	μA
	I <sub>O</sub> IR	I <sub>F</sub> =4mA, V <sub>R</sub> =2.5V, d=2.0mm*5	0.6	—	1.8	μA
Operating Dark Current *4	I <sub>LD</sub> RED	I <sub>F</sub> =4mA, V <sub>R</sub> =2.5V, Without reflective plate	—	20	100	nA
	I <sub>LD</sub> IR	I <sub>F</sub> =4mA, V <sub>R</sub> =2.5V, Without reflective plate	—	20	100	nA
Response Time(Rise/Fall)	t <sub>r</sub> , t <sub>f</sub> RED	V <sub>R</sub> =0V, R <sub>L</sub> =1kΩ	—	400	—	ns
		V <sub>R</sub> =2.5V, R <sub>L</sub> =1kΩ	—	250	—	ns
	t <sub>r</sub> , t <sub>f</sub> IR	V <sub>R</sub> =0V, R <sub>L</sub> =1kΩ	—	700	—	ns
		V <sub>R</sub> =2.5V, R <sub>L</sub> =1kΩ	—	400	—	ns

\*1 Pulse duty 10% (Pulse width 200us, Period 20ms)

\*2 This is represented as Emission wavelength range of LED. The emission wavelength verification test has not confirmed in the manufacturing process.

\*3 Please refer to "Output Current Test Condition".

\*4 I<sub>LD</sub> may increase according to the periphery situation of the surface mounted condition.

\*5 Distance from the package undersurface to the aluminum evaporation surface.

Note: In the Electro-Optical characteristics table, items that are showed only the typical value are not tested in manufacturing process.

## ■ OUTPUT CURRENT TEST CONDITION

The signal from LED is reflected at the aluminum surface.

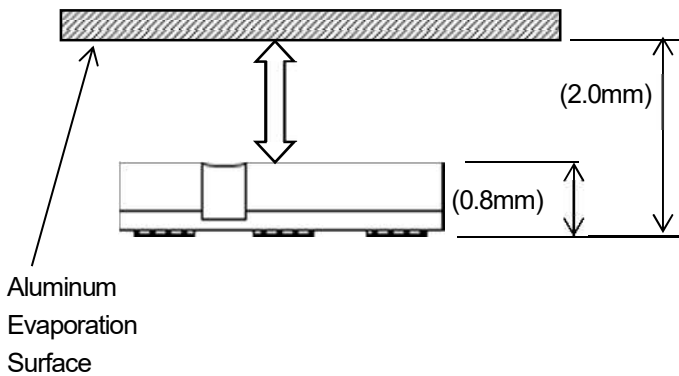

## ■ DARK CURRENT TEST CONDITION

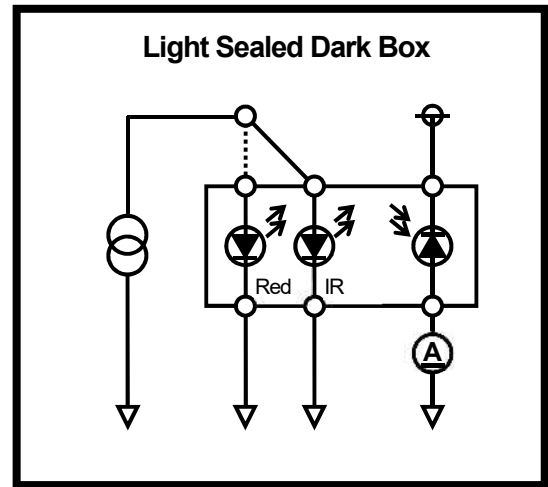

## ■ RESPONSE TEST CONDITION

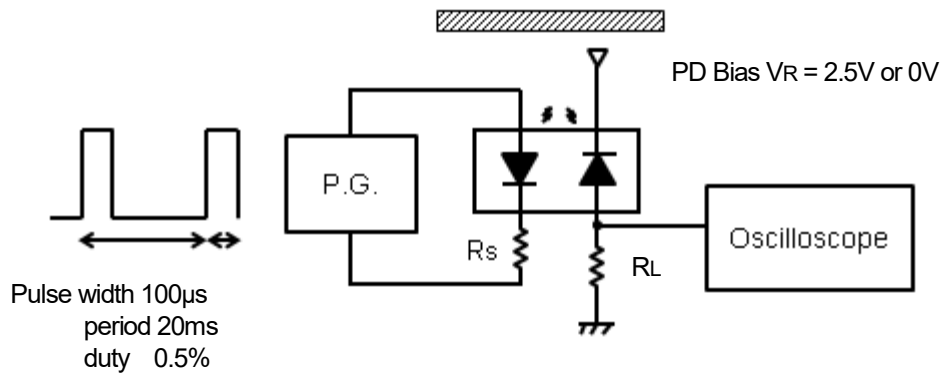

## ■ OUTPUT CURRENT vs. DISTANCE TIME TEST CONDITION

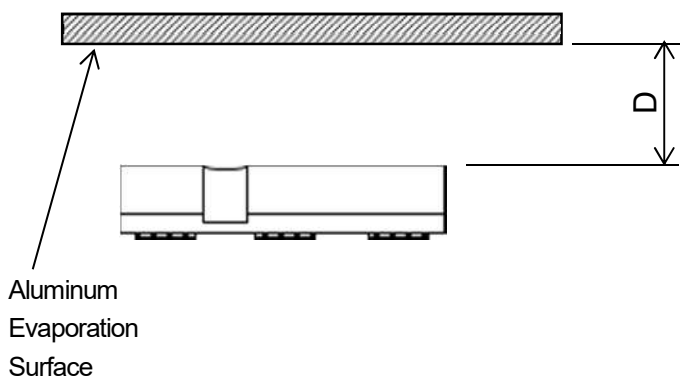

## POWER DISSIPATION vs. AMBIENT TEMPERATURE

Power Dissipation vs. Temperature

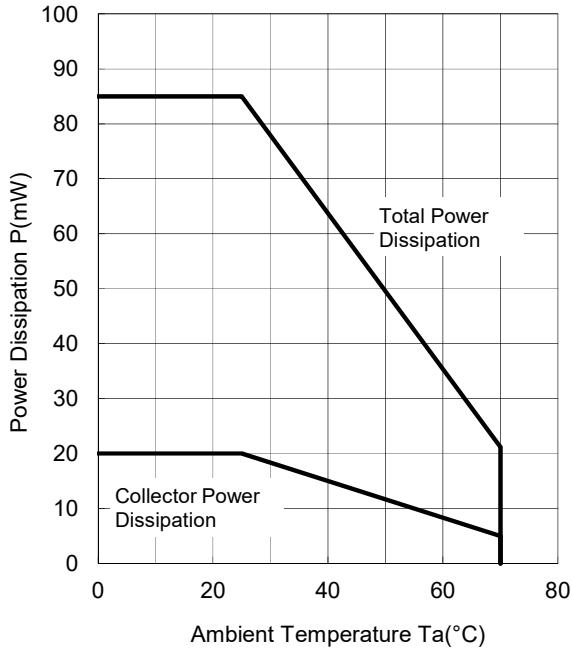

Forward Current vs. Temperature  
RED LED

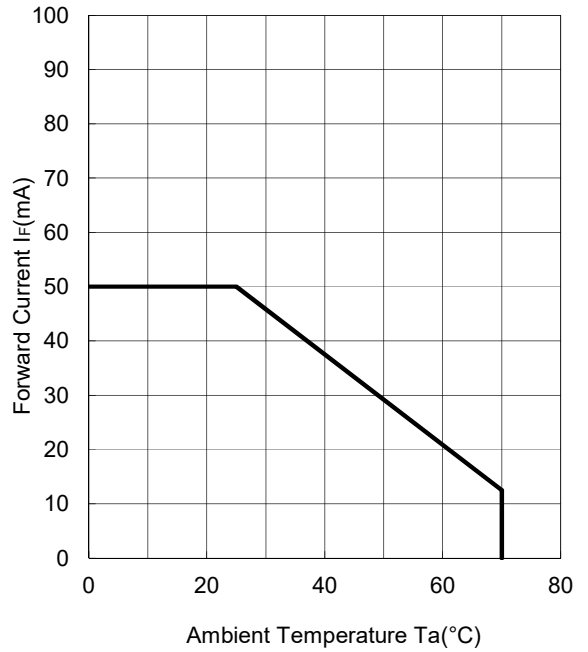

Forward Current vs. Temperature  
IR LED

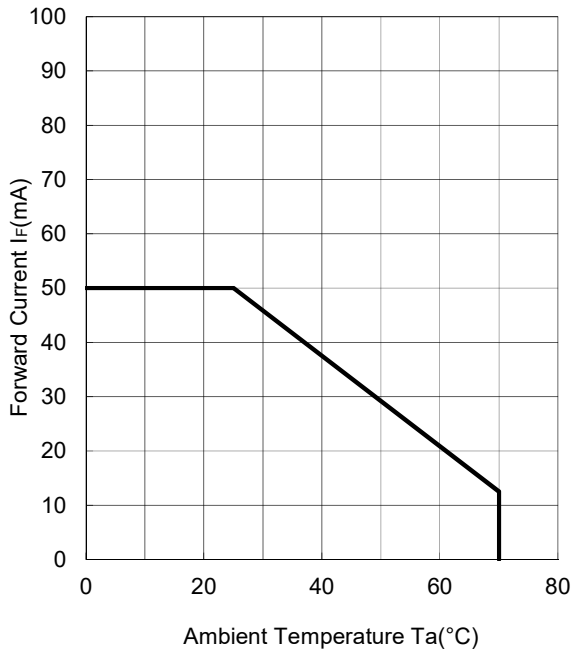

## ■ TYPICAL CHARACTERISTICS RELATED RED EMITTER

**Forward Voltage vs. Forward Current  
RED LED**

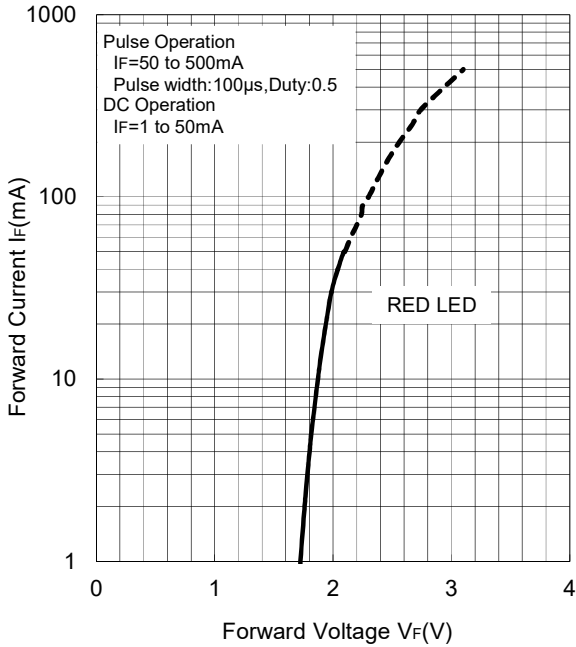

**Forward Voltage vs. Temperature**

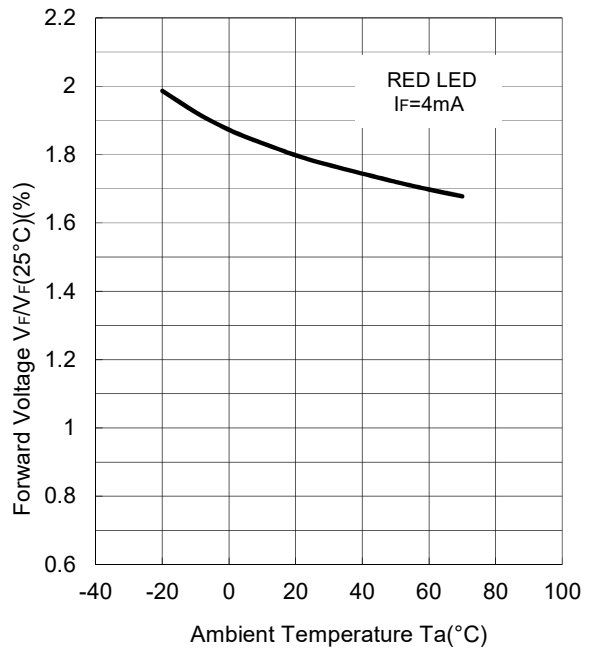

**Operating Dark Current vs. Temperature  
RED LED**

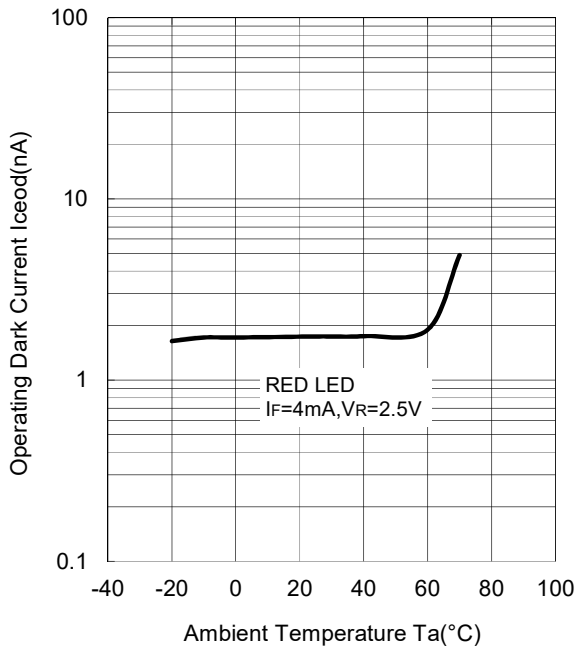

**Spectral Response ( $T_a = 25^\circ\text{C}$ )  
Emitter RED LED**

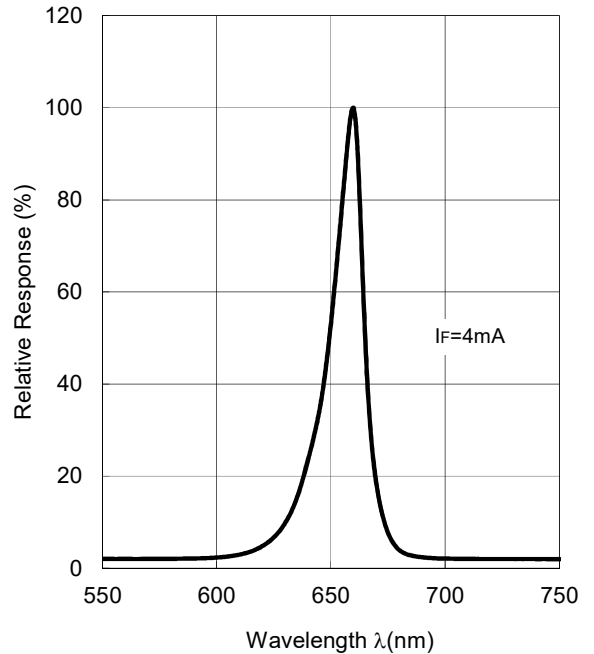

**Output Current vs. Forward Current**  
RED LED (Ta=25°C)

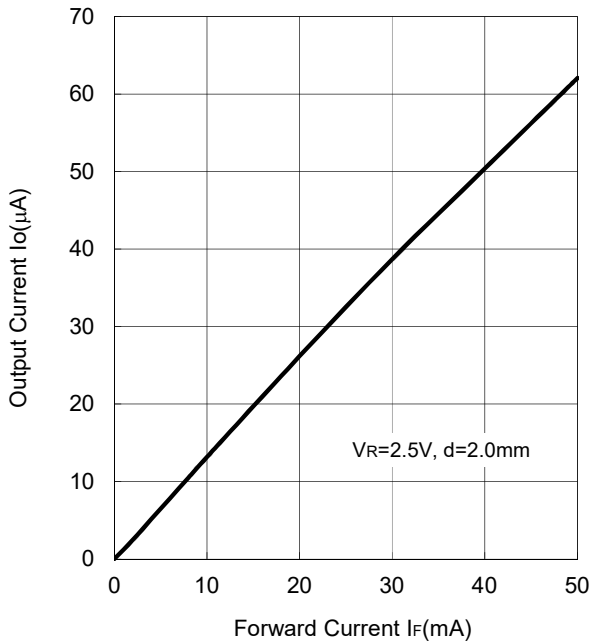

**Output Current vs. Temperature**  
RED LED

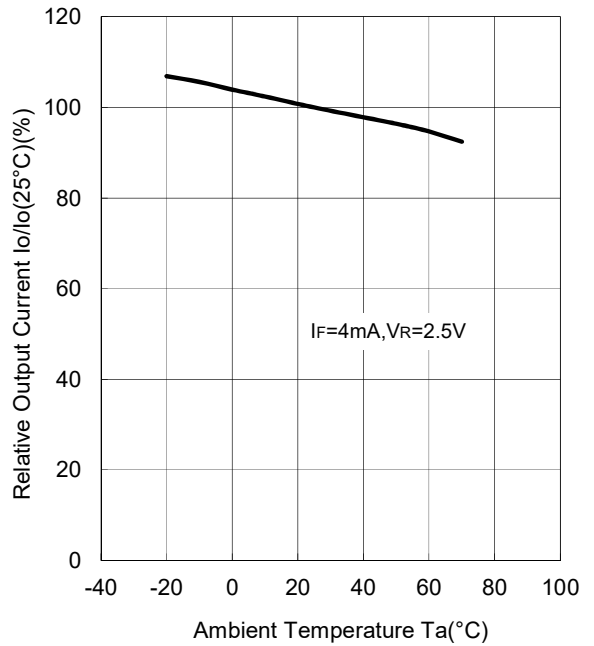

**Output Current vs. Distance**  
RED LED (Ta=25°C)

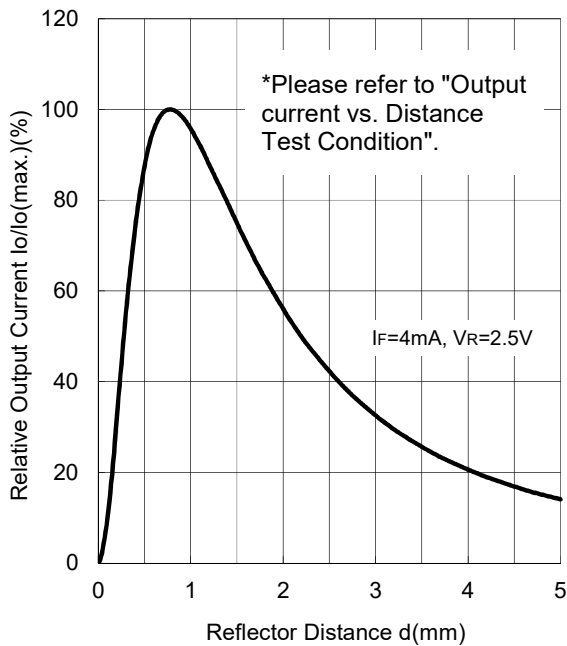

**Switching Time vs. Load Resistance**  
(Ta=25°C)

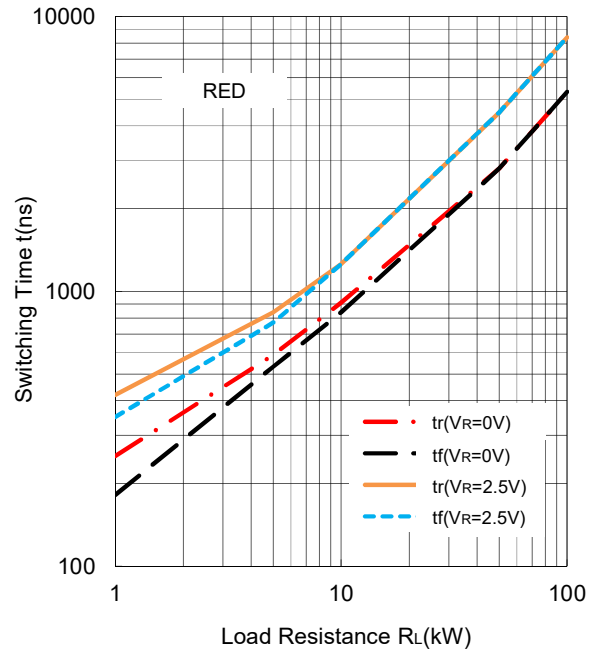

## ■ TYPICAL CHARACTERISTICS RELATED INFRARED EMITTER

**Forward Voltage vs. Forward Current**  
IR LED

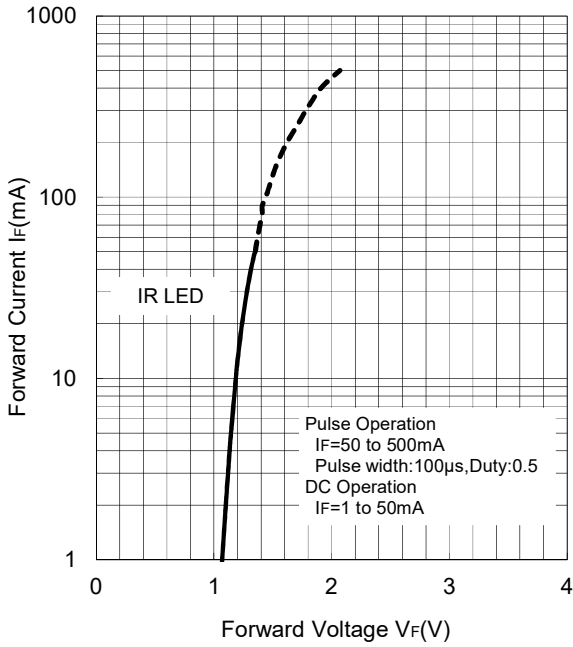

**Forward Voltage vs. Temperature**

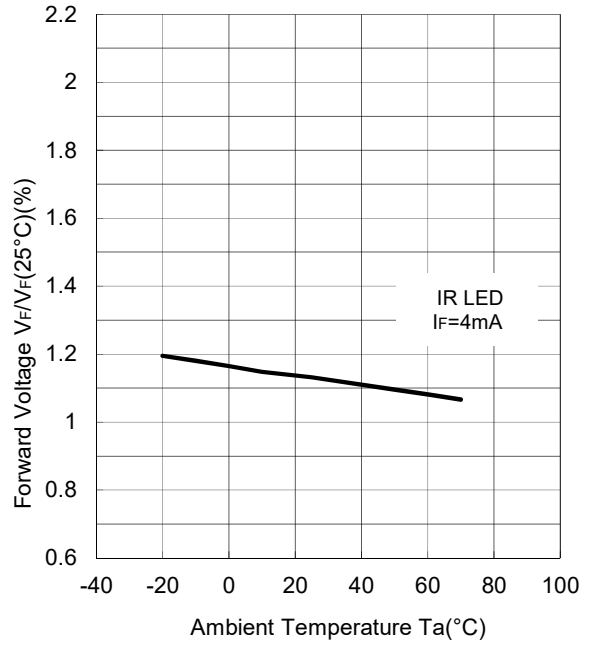

**Operating Dark Current vs. Temperature**  
IR LED

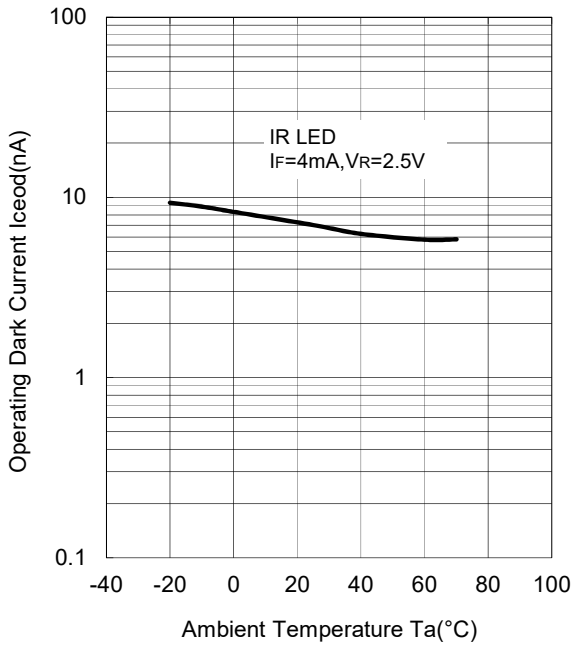

**Spectral Response ( $T_a=25^\circ\text{C}$ )**  
Emitter IR LED

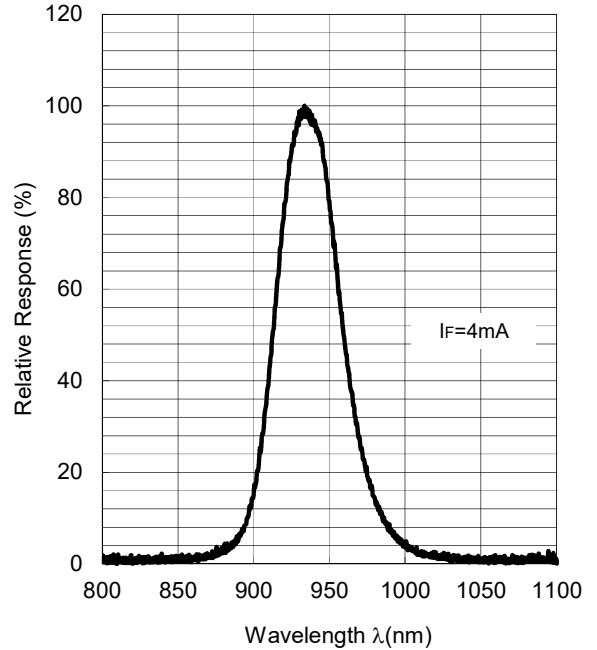



**Output Current vs. Forward Current**  
IR LED (Ta=25°C)

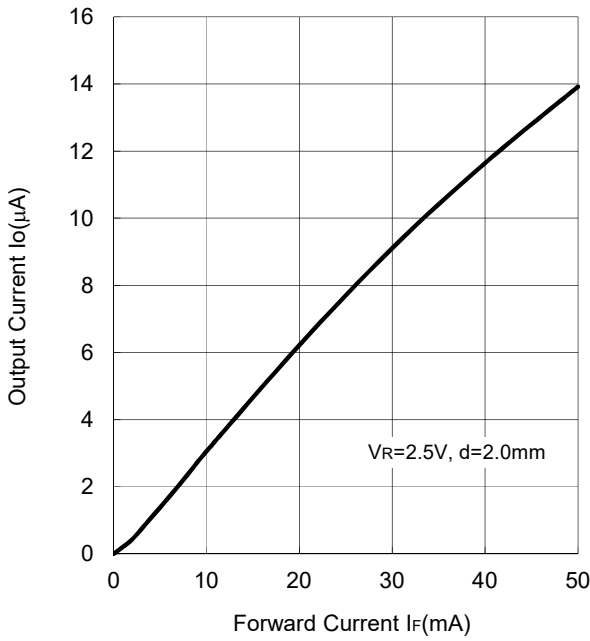

**Output Current vs. Temperature**  
IR LED

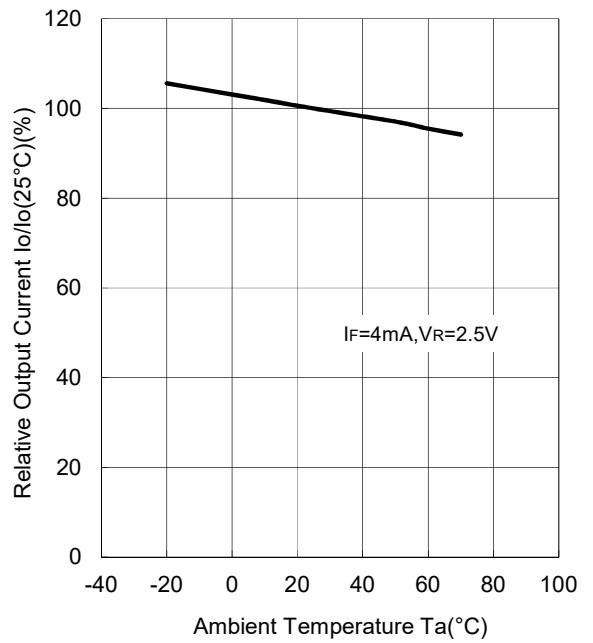

**Output Current vs. Distance**  
IR LED (Ta=25°C)

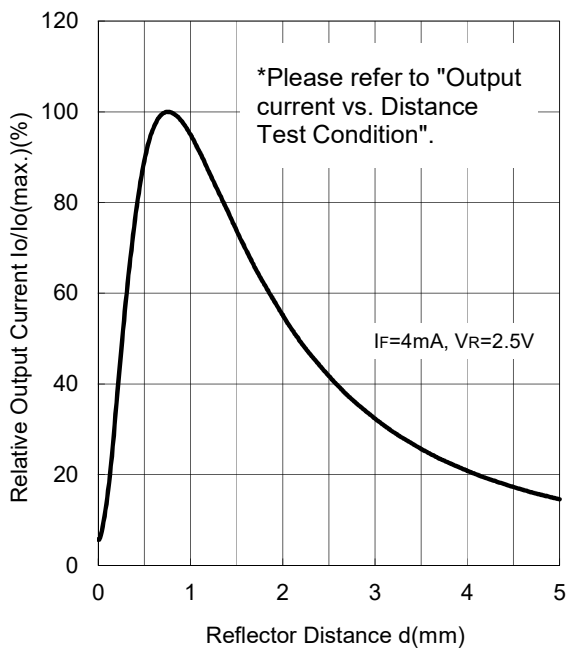

**Switching Time vs. Load Resistance**  
(Ta=25°C)

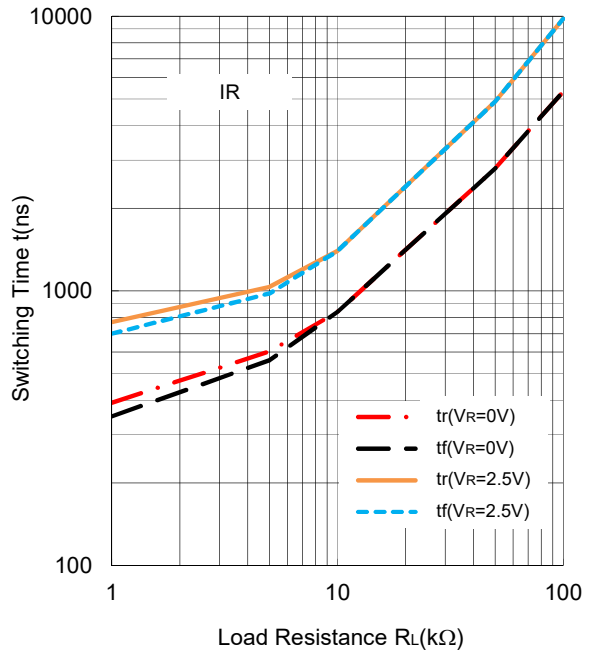

## ■ TYPICAL CHARACTERISTICS RELATED DETECTOR

Dark Current vs. Temperature

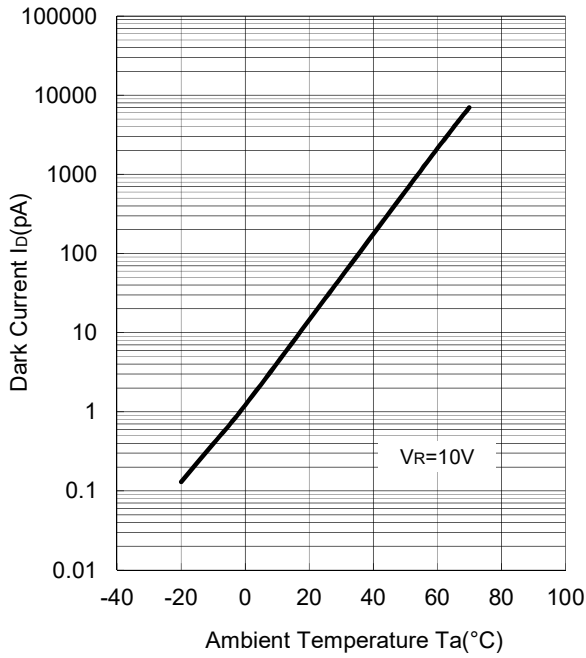

Capacitance vs. Reverse Voltage  
( $T_a=25^\circ\text{C}$ )

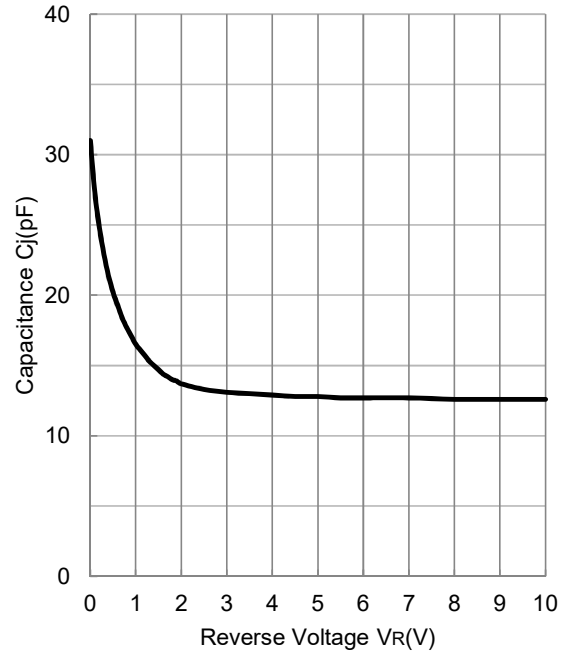

Spectral Response ( $T_a=25^\circ\text{C}$ )  
Detector

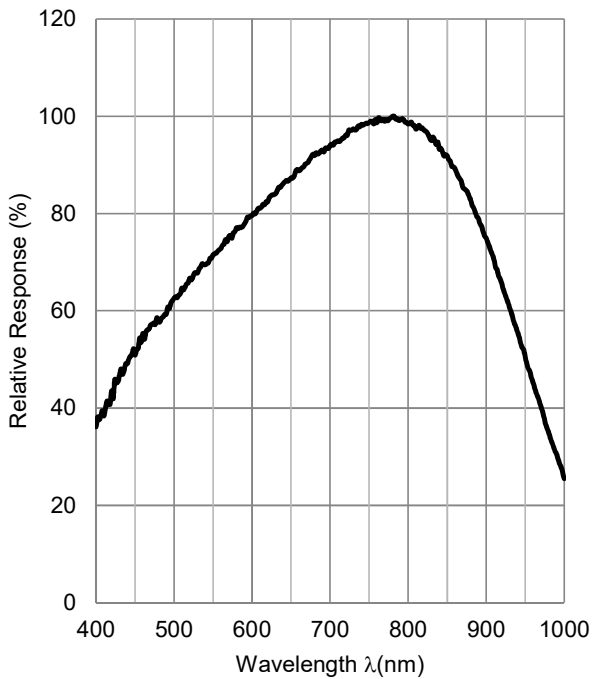

Directivity at Package direction X

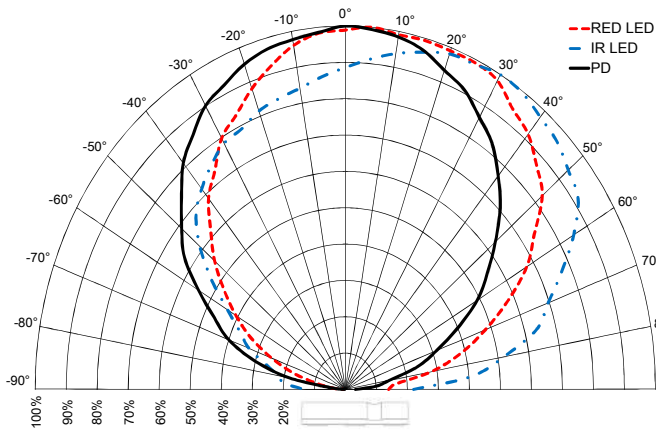

Directivity at Package direction Y

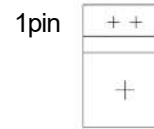
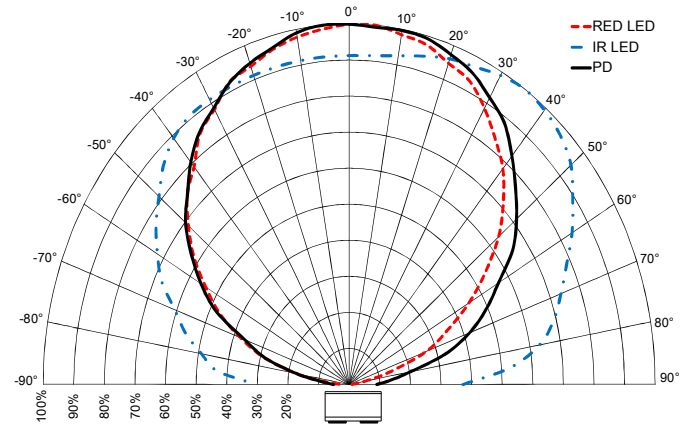

**■APPLICATION NOTE****(1) Attention in handling**

Treat not to touch the light receiving and light emitting part.

Avoid to adhering the dust and any other foreign materials on the light receiving and light emitting part when using.

When LED has operated by voltage, it should be connected the resistor of current adjustment. Avoid to applying direct voltage to LED, because there is possibility that LED is destroyed.

When mounting, special care has to be taken on the mounting position and tilting of the device because it is very important to place the device to the optimum position to the object.

**(2) Attention in designing**

Avoid the entering ambient light into light receiving part for avoid the malfunction by ambient light. Furthermore, there is possibility of malfunction when there are the other mounted parts by near this product peripheral.

There will be changing characteristics by detection object. Refer to this datasheet and evaluate by actual detection object.

When LED has been applied continuous power on long period of time, the output current is dropped. If it uses by always applying power to LED, have to consider the circuit designing of including output current decrease.

■PACKAGE OUTLINE Unit: mm

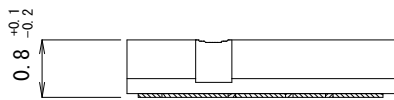
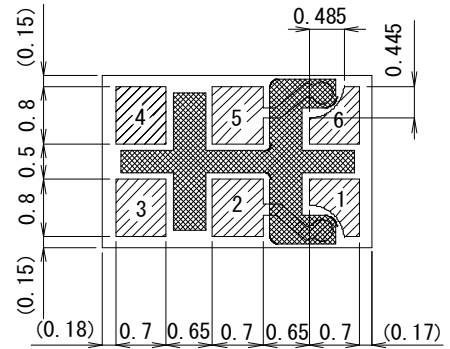
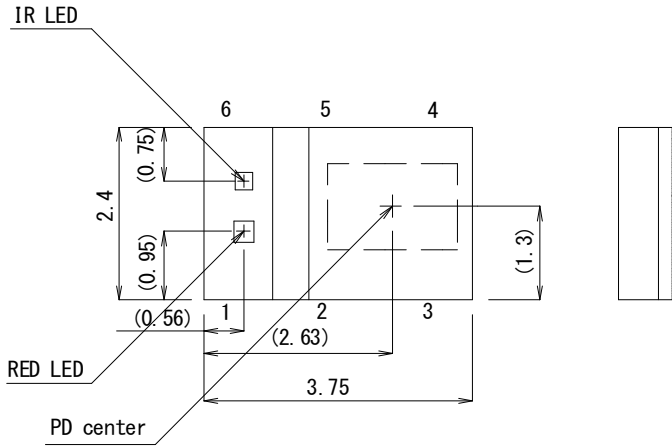

Foot Pattern

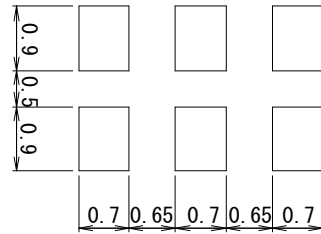

- 1. LRK
- 2. LRA
- 3. PA
- 4. PK
- 5. LIRA
- 6. LIRK

Unspecified tolerance :  $\pm 0.1\text{mm}$   
 Dimensions in parenthesis are shown for reference.

## PACKING SPECIFICATION

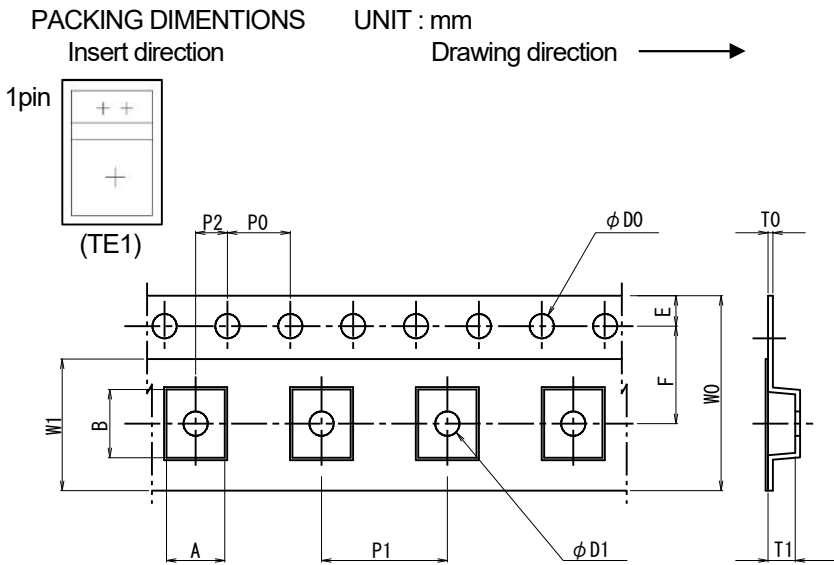

SYMBOL	DIMENSION	REMARKS
A	2.75 ±0.10	BOTTOM DIMENSION
B	4.1 ±0.10	BOTTOM DIMENSION
D0	φ1.50 <sup>+0.1</sup> <sub>-0</sub>	
D1	φ1.50 <sup>+0.2</sup> <sub>-0</sub>	
E	1.75 ±0.10	
F	5.50 ±0.05	
P0	4.00 ±0.10	
P1	4.00 ±0.10	
P2	2.00 ±0.05	
T0	0.25 ±0.05	
T1	1.15 ±0.10	
W0	12.00 ±0.10	
W1	9.3 ±0.10	THICKNESS 0.1MAX

\* Carrier tape material : Polycarbonate(antistatic)  
Cover tape material : PP(antistatic)

## Taping Strength

There is a peel strength in the range of 0.2 to 0.7N when was peeled at a rate of 300mm per minute in opening angle 165 to 180° between the carrier tape and the cover tape.

## Packaging

- 1) The taped products are to be rolled up on the taping reel as on the drawing.
- 2) Rolling up specification
  - 2-1) Start rolling : Carrier tape open space more than 20 Pieces.
  - 2-2) End of rolling : Carrier tape open space more than 20 Pieces, and 2 round of reel space at the cover tape only.
- 3) Taping quantity : 3,000 Pieces
- 4) Seal off after putting each reels in a damp proof bag with silica gel.

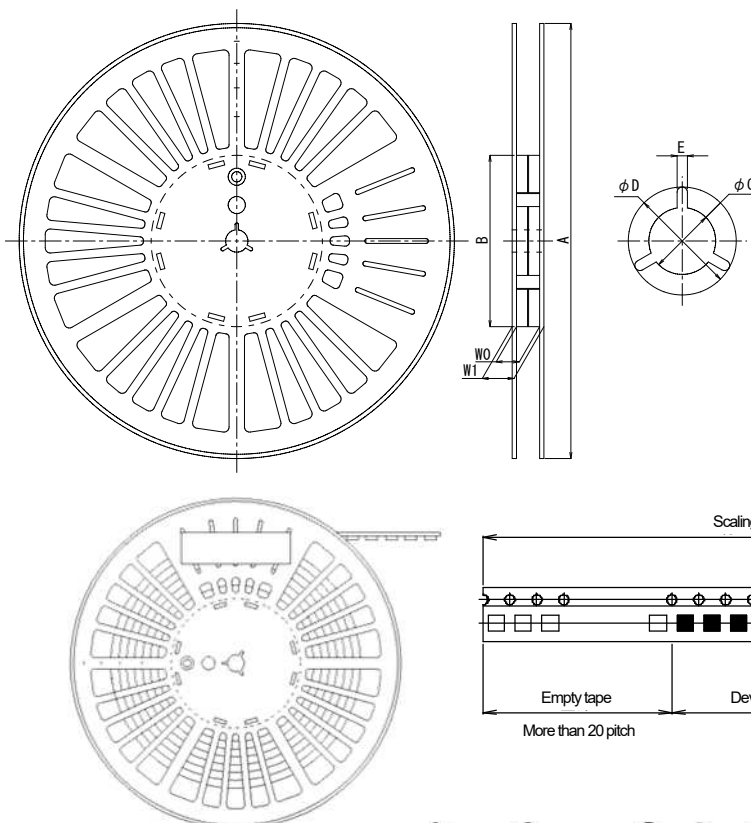

SYMBOL	DIMENSION
A	φ254 ±1.0
B	φ100 ±1.0
C	φ13 ±0.2
D	φ21 ±0.8
E	2.0 ±0.5
W0	13.5 ±1.0
W1	18.5 ±1.0

\* Reel material : PPE(antistatic)

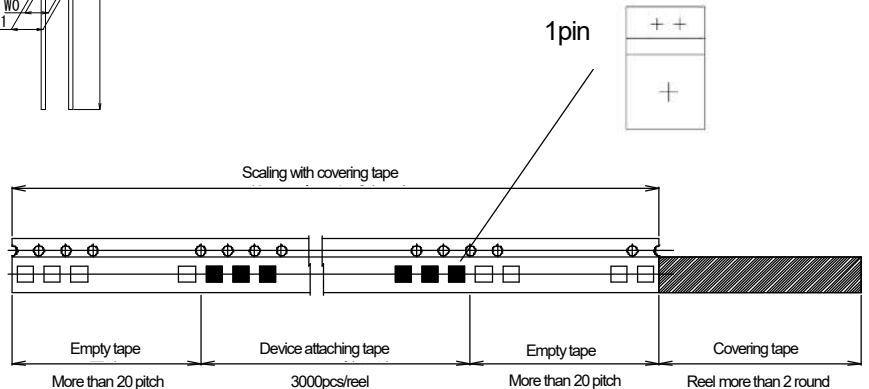

## RECOMMENDED MOUNTING METHOD

### NOTE

Mounting was evaluated with the following profiles in our company, so there was no problem.  
However, confirm mounting by the condition of your company beforehand.

The exposure of device under higher temperature many affect to the reliability of the products, it is recommended to complete soldering in the shortest time possible.

Mounting: Two Times soldering is allowed.

## INFRARED REFLOW SOLDERING METHOD

Recommended reflow soldering procedure

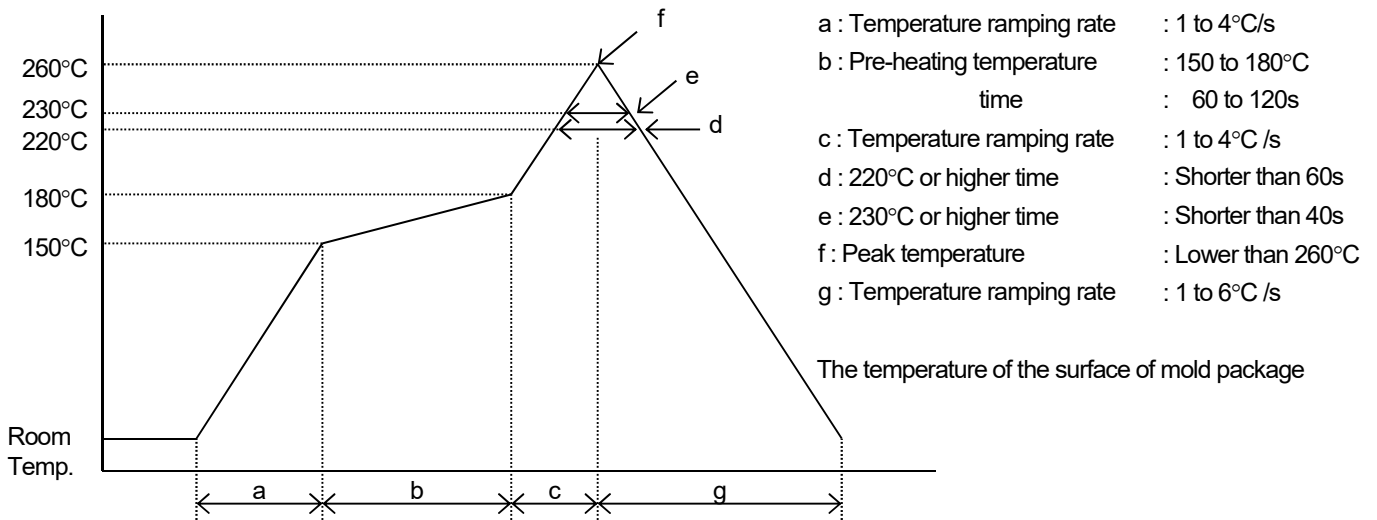

(NOTE1) Using reflow furnace with short wave infrared radiation heater such as halogen lamp

Regarding temperature profile, please refer to those fo reflow furnace.

In this case the resin surface temperature may become higher than lead terminals due to endothermic ally of black colored mold resin. Therefore, please avoid from direct exposure to mold resin.

(NOTE2) Other method

Such other methods of soldering as dipping the device into melted solder and vapor phase method (VPS) are not appropriate because the body of device will be heated rapidly. Therefore, these are not recommended to apply.

(NOTE3) The resin gets softened right after soldering, so, the following care has to be taken

Not to contact the lens surface to anything.

Not to dip the device into water or any solvents.

## FLOE SOLDERING METHOD

Flow soldering is not possible.

## IRON SOLDERING METHOD

Iron soldering is not possible.

**■ CLEANING**

Avoid washing the device after soldering by reflow method.

**■ IC STORAGE CONDITIONS AND ITS DURATION****(1) Temperature and humidity ranges**

Pack Sealing	Temperature:	5 to 40 [°C]
	Humidity:	40 to 80 [%]
Pack Opening	Temperature:	5 to 30 [°C]
	Humidity:	40 to 70 [%]

After opening the bag, solder products within 48h.

Avoid a dry environment below 40% because the products are easily damageable by the electrical discharge.

Store the products in the place where it does not create dew with the products due to a sudden change in temperature.

(2) When baking, place the reel vertically to avoid load to the side.

(3) Do not store the devices in corrosive-gas atmosphere.

(4) Do not store the devices in a dusty place.

(5) Do not expose the devices to direct rays of the sun.

(6) Do not allow external forces or loads to be applied to IC's.

(7) Be careful because affixed label on the reel might be peeled off when baking.

(8) The product is recommended to do the baking before using for the stability of the quality.

**■ BAKING**

In case of keeping expect above condition be sure to apply baking.

Baking method: Ta=60°C, 48 to 72h, Three times baking is allowed

**■ STORAGE DURATION**

Within a year after delivering this device.

For the products stored longer than a year, confirm their terminals and solderability before they are used.

**■ MOISTURE SENSITIVITY LEVELS**

JEDEC : Level 5



## [ CAUTION ]

1. New JRC strives to produce reliable and high quality semiconductors. New JRC's semiconductors are intended for specific applications and require proper maintenance and handling. To enhance the performance and service of New JRC's semiconductors, the devices, machinery or equipment into which they are integrated should undergo preventative maintenance and inspection at regularly scheduled intervals. Failure to properly maintain equipment and machinery incorporating these products can result in catastrophic system failures
2. The specifications on this datasheet are only given for information without any guarantee as regards either mistakes or omissions. The application circuits in this datasheet are described only to show representative usages of the product and not intended for the guarantee or permission of any right including the industrial rights. All other trademarks mentioned herein are property of their respective companies.
3. To ensure the highest levels of reliability, New JRC products must always be properly handled. The introduction of external contaminants (e.g. dust, oil or cosmetics) can result in failures of semiconductor products.
4. New JRC offers a variety of semiconductor products intended for particular applications. It is important that you select the proper component for your intended application. You may contact New JRC's Sale's Office if you are uncertain about the products listed in this catalog.
5. Special care is required in designing devices, machinery or equipment which demand high levels of reliability. This is particularly important when designing critical components or systems whose failure can foreseeably result in situations that could adversely affect health or safety. In designing such critical devices, equipment or machinery, careful consideration should be given to amongst other things, their safety design, fail-safe design, back-up and redundancy systems, and diffusion design.
6. The products listed in the catalog may not be appropriate for use in certain equipment where reliability is critical or where the products may be subjected to extreme conditions. You should consult our sales office before using the products in any of the following types of equipment.

Aerospace Equipment  
Equipment Used in the Deep Sea  
Power Generator Control Equipment (Nuclear, Steam, Hydraulic)  
Life Maintenance Medical Equipment  
Fire Alarm/Intruder Detector  
Vehicle Control Equipment (airplane, railroad, ship, etc.)  
Various Safety devices

7. New JRC's products have been designed and tested to function within controlled environmental conditions. Do not use products under conditions that deviate from methods or applications specified in this catalog. Failure to employ New JRC products in the proper applications can lead to deterioration, destruction or failure of the products. New JRC shall not be responsible for any bodily injury, fires or accident, property damage or any consequential damages resulting from misuse or misapplication of its products. Products are sold without warranty of any kind, either express or implied, including but not limited to any implied warranty of merchantability or fitness for a particular purpose.
8. Warning for handling Gallium and Arsenic (GaAs) Products (Applying to GaAs MMIC, Photo Reflector). This Products uses Gallium (Ga) and Arsenic (As) which are specified as poisonous chemicals by law. For the prevention of a hazard, do not burn, destroy, or process chemically to make them as gas or power. When the product is disposed, please follow the related regulation and do not mix this with general industrial waste or household waste.
9. The product specifications and descriptions listed in this catalog are subject to change at any time, without notice.

