

RoHS  
IP66~68

REV.	DESCRIPTION	DATE
A	ISSUE	Jan/09/2013
A1	Add Pin Assignment	Aug/29/2014

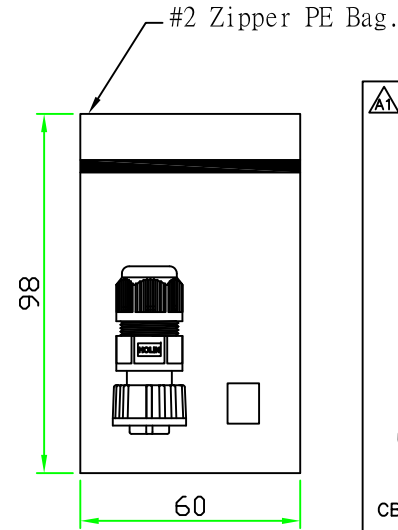
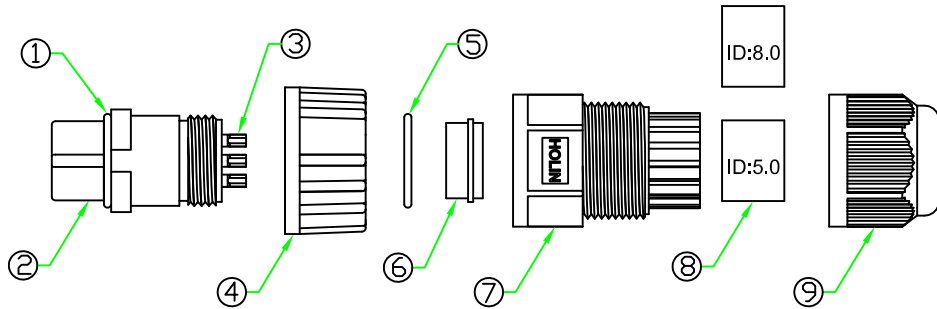
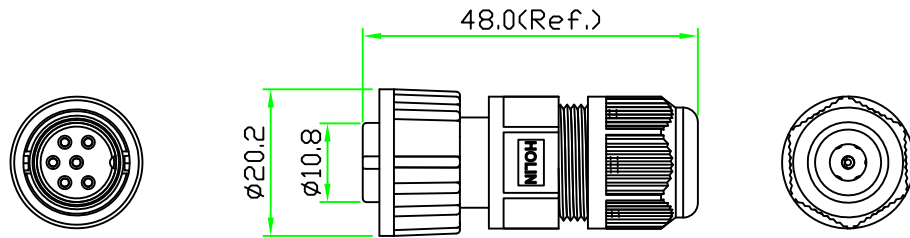
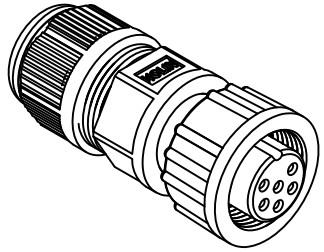

NOTES:

1. ELECTRICAL CHARACTERISTICS:

CURRENT RATING: 2A / 5A /10A

CONNECTOR TEMPERATURE RANGE: -40°C TO +105°C

DIELECTRIC WITHSTANDING VOLTAGE:

500V AC FOR ONE MINUTE

2. HOW TO ORDER: CBx-P2xxSA

- 02 - 2 PIN 07 - 7 PIN
- 03 - 3 PIN 08 - 8 PIN
- 04 - 4 PIN 10 - 10 PIN
- 05 - 5 PIN 12 - 12 PIN
- 06 - 6 PIN

- P - CURRENT RATING 10A
- D - CURRENT RATING 5A
- N - CURRENT RATING 2A

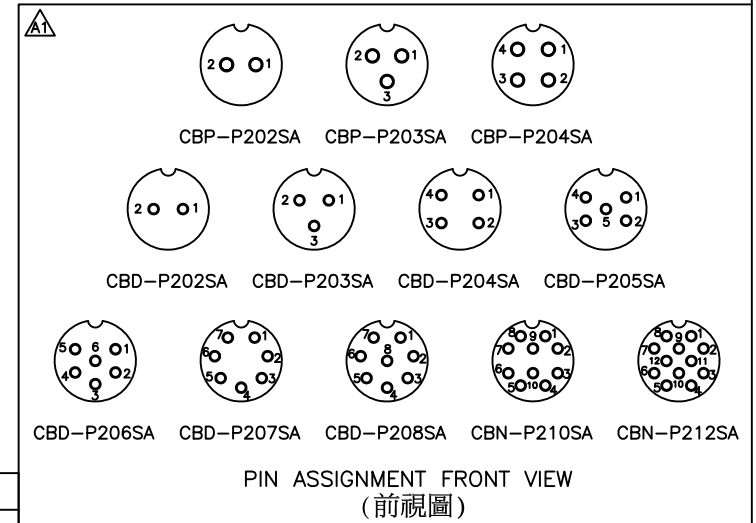

9	CLAMP NUT	NYLON+GF	BLACK	1	
8	TUBE	EPDM, (ID= 5.0 & 8.0mm.)	BLACK	2	
7	HOOD	NYLON	BLACK	1	
6	GASKET	EPDM.	BLACK	1	
5	O-RING	NBR.	BLACK	1	
4	SCREW NUT	NYLON+GF	BLACK	1	
3	CONTACT	BRASS, Female Pin. 6u"Gold Plated.		N	
2	CONNECTOR	B Size Female Connector Insert, NYLON+GF.		1	
1	O-RING	VITON	BLACK	1	
No.	PART NAME	DESCRIPTION	COLOR	Q'TY	REMARKS

		UNIT: mm	<b>TITLE :</b> Circular B Size Screw Type Female Connector Female Pin Field Installable Plug	
		SCALE 1:1		
UNLESS OTHERWISE SPECIFIED TOLERANCES: .x ± 0.25 .xx ± 0.1 .xxx ± 0.05 ANGLE ± 1°		<b>P/N:</b> CBx-P2xxSA	DR.	Patty
REV. A1	SHEET 1/1		CH.	ERIC
		<b>DWG.NO:</b> CBx-P2xxSA	AP.	

RoHS

REV.	DESCRIPTION	DATE
A	ISSUE	Sep/26/2020

NOTES:

1. ELECTRICAL CHARACTERISTICS:

CURRENT RATING: 10A

CONNECTOR TEMPERATURE RANGE: -40°C TO +105°C

DIELECTRIC WITHSTANDING VOLTAGE:

500V AC FOR ONE MINUTE

2. HOW TO ORDER: CBP-P2xxSAC

02 - 2 PIN

03 - 3 PIN

04 - 4 PIN

P - CURRENT RATING 10A

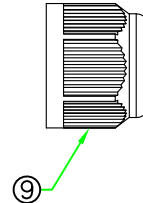
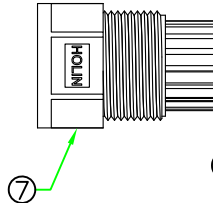
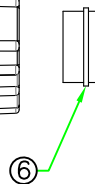
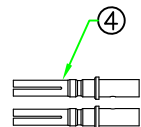
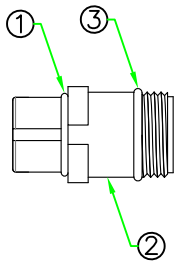
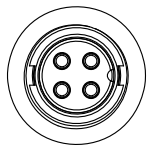
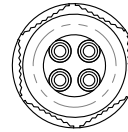
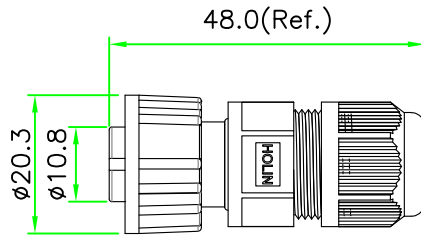
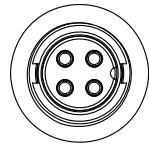
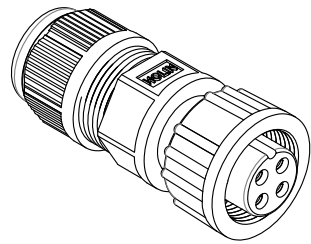

#2 Zipper PE Bag.

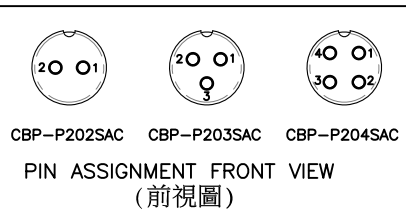
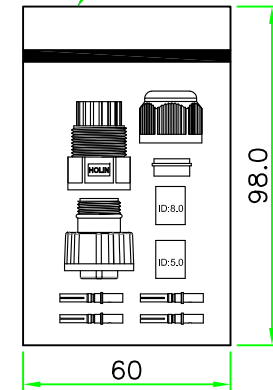

9	CLAMP NUT	NYLON+GF	BLACK	1	
8	TUBE	EPDM, (ID= 5.0 & 8.0mm.)	BLACK	2	
7	HOOD	NYLON	BLACK	1	
6	GASKET	SILICON.	BLACK	1	
5	SCREW NUT	NYLON+GF	BLACK	1	
4	CONTACT	BRASS ,Female Pin. 6u"Gold Plated.		N	
3	O-RING	EPDM.	BLACK	1	
2	CONNECTOR	B Size Female Connector Insert, NYLON+GF.		1	
1	O-RING	NBR.	BLACK	1	
No.	PART NAME	DESCRIPTION	COLOR	Q'TY	REMARKS

**HOLIN®** HTP ASIA TECHNOLOGY CO., LTD.  
禾凌科技股份有限公司

	UNIT: mm	TITLE :	Circular B Size Screw Type Female Connector Female Pin Field Installable Plug with Crimp Pin
SCALE	1:1	P/N:	CBP-P2xxSAC
UNLESS OTHERWISE SPECIFIED TOLERANCES: X ±1.0 XX ±0.5 XXX ±0.25 ANGLE ± 1° REV. SHEET		DWG.NO:	CBP-P2xxSAC
A	1/1	DR.	James
		CH.	ERIC
		AP.	