

SOT-23 Plastic - Encapsulate Transistors

FEATURES

- High Collector Current
- Complementary to TKSS8050

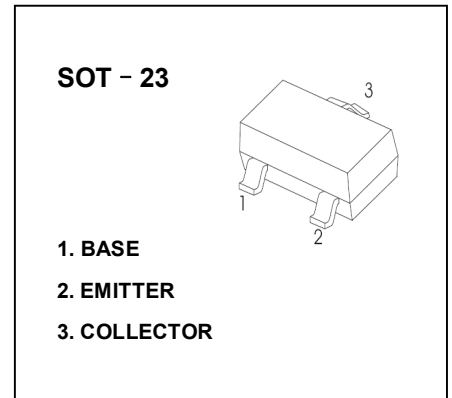

MAXIMUM RATINGS (T_a=25°C unless otherwise noted)

Symbol	Parameter	Value	Unit
V _{CB0}	Collector-Base Voltage	-40	V
V _{CEO}	Collector-Emitter Voltage	-25	V
V _{EBO}	Emitter-Base Voltage	-5	V
I _C	Collector Current	-1.5	A
P _C	Collector Power Dissipation	300	mW
R _{θJA}	Thermal Resistance From Junction To Ambient	417	°C/W
T _j	Junction Temperature	150	°C
T _{stg}	Storage Temperature	-55~+150	°C

ELECTRICAL CHARACTERISTICS (T_a=25°C unless otherwise specified)

Parameter	Symbol	Test conditions	Min	Typ	Max	Unit
Collector-base breakdown voltage	V _{(BR)CBO}	I _C =-100μA, I _E =0	-40			V
Collector-emitter breakdown voltage	V _{(BR)CEO}	I _C =-0.1mA, I _B =0	-25			V
Emitter-base breakdown voltage	V _{(BR)EBO}	I _E =-100μA, I _C =0	-5			V
Collector cut-off current	I _{CBO}	V _{CB} =-40V, I _E =0			-100	nA
Collector cut-off current	I _{CEO}	V _{CE} =-20V, I _B =0			-100	nA
Emitter cut-off current	I _{EBO}	V _{EB} =-5V, I _C =0			-100	nA
DC current gain	h _{FE(1)}	V _{CE} =-1V, I _C =-100mA	200		350	
	h _{FE(2)}	V _{CE} =-1V, I _C =-800mA	40			
Collector-emitter saturation voltage	V _{CE(sat)}	I _C =-800mA, I _B =-80mA			-0.5	V
Base-emitter saturation voltage	V _{BE(sat)}	I _C =-800mA, I _B =-80mA			-1.2	V
Base-emitter voltage	V _{BE}	V _{CE} =-1V, I _C =-10mA			-1	V
Transition frequency	f _T	V _{CE} =-10V, I _C =-50mA, f=30MHz	100			MHz
Collector output capacitance	C _{ob}	V _{CB} =-10V, I _E =0, f=1MHz			20	pF

CLASSIFICATION OF h_{FE(1)}

RANGE	200 - 350
MARKING	Y2

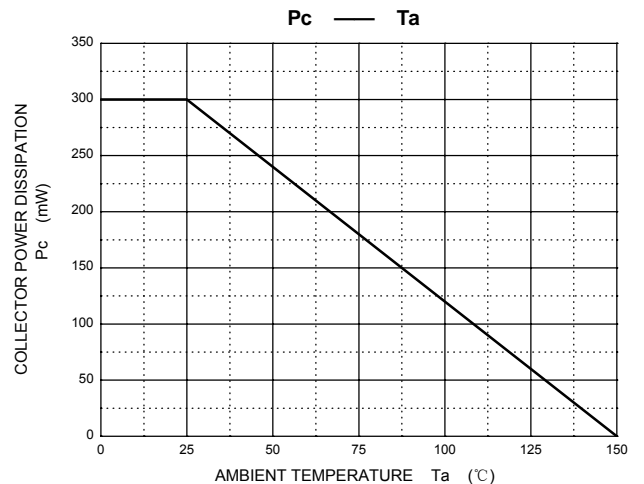
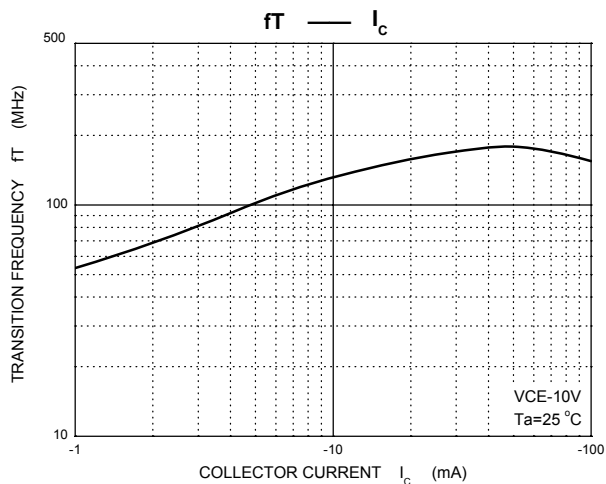
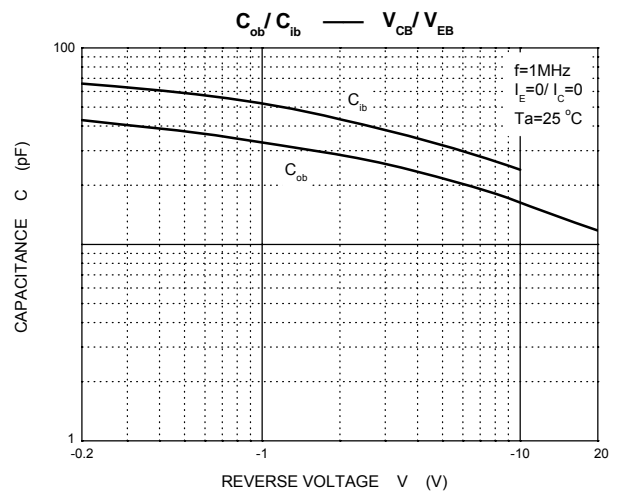
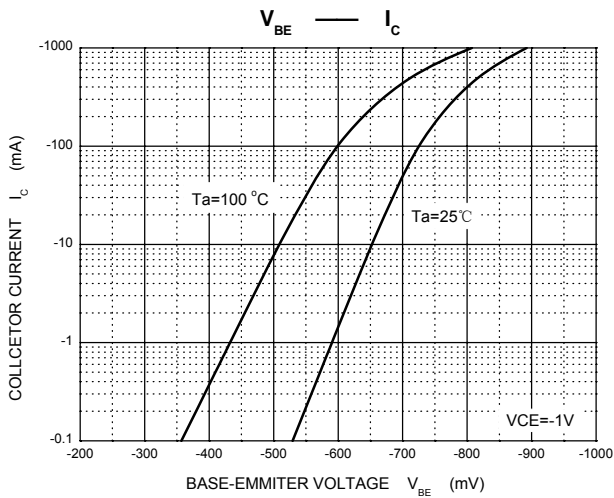
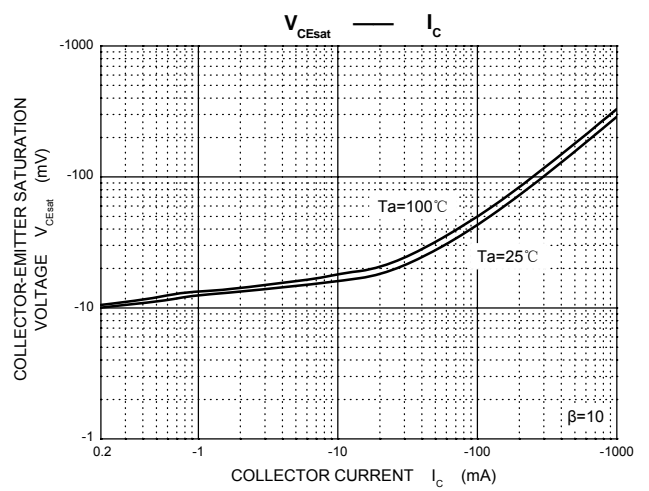
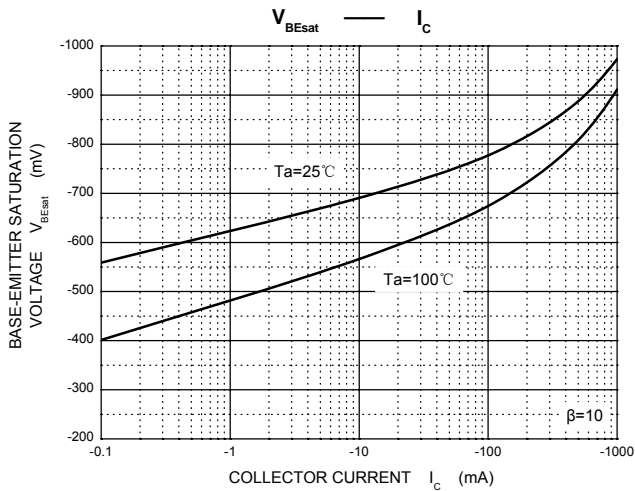
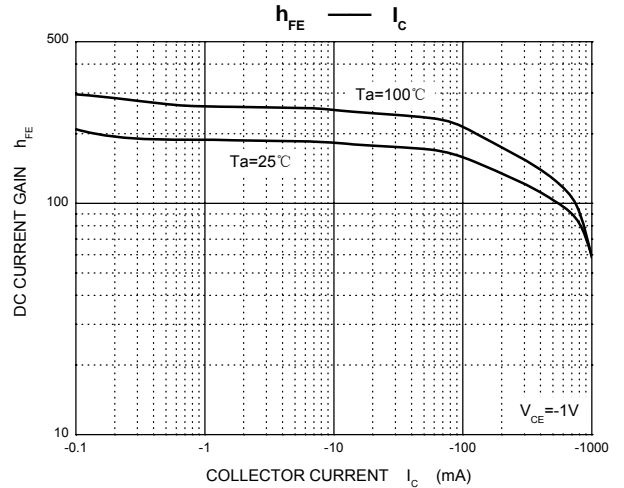
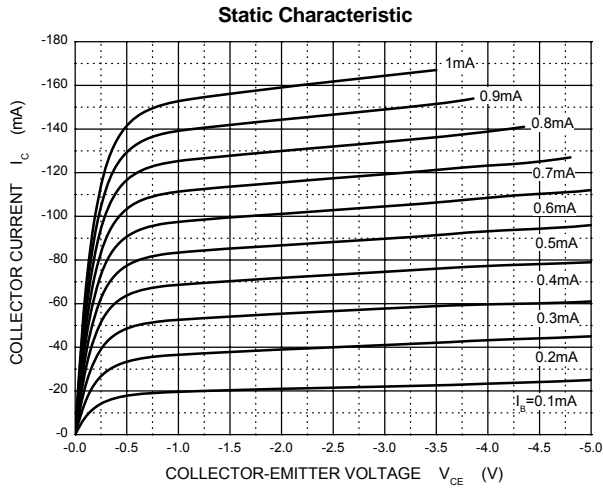

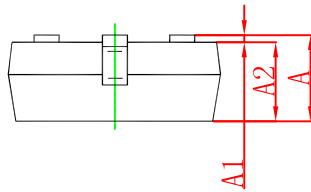
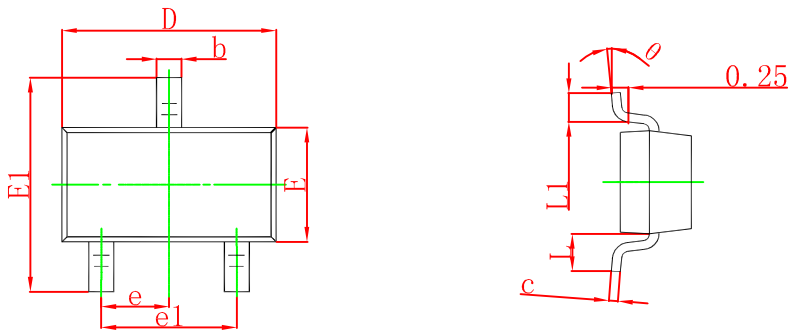

Symbol	Dimensions In Millimeters		Dimensions In Inches	
	Min	Max	Min	Max
A	0.900	1.150	0.035	0.045
A1	0.000	0.100	0.000	0.004
A2	0.900	1.050	0.035	0.041
b	0.300	0.500	0.012	0.020
c	0.080	0.150	0.003	0.006
D	2.800	3.000	0.110	0.118
E	1.200	1.400	0.047	0.055
E1	2.250	2.550	0.089	0.100
e	0.950 TYP		0.037 TYP	
e1	1.800	2.000	0.071	0.079
L	0.550 REF		0.022 REF	
L1	0.300	0.500	0.012	0.020
θ	0°	8°	0°	8°

SOT-23 Suggested Pad Layout

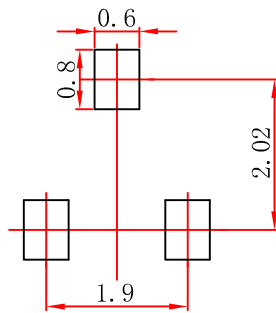

- Note:
1. Controlling dimension: in millimeters.
 2. General tolerance: $\pm 0.05\text{mm}$.
 3. The pad layout is for reference purposes only.