

RoHS

IP66-68

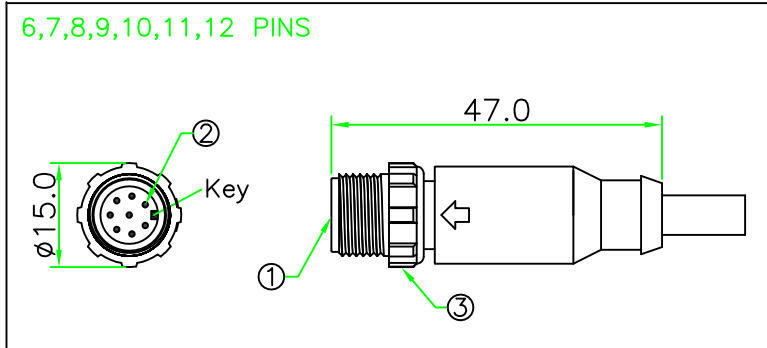

\*Cable specification and length can be customized.

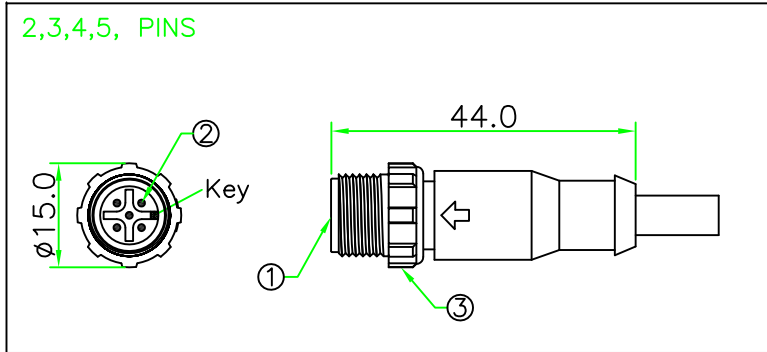
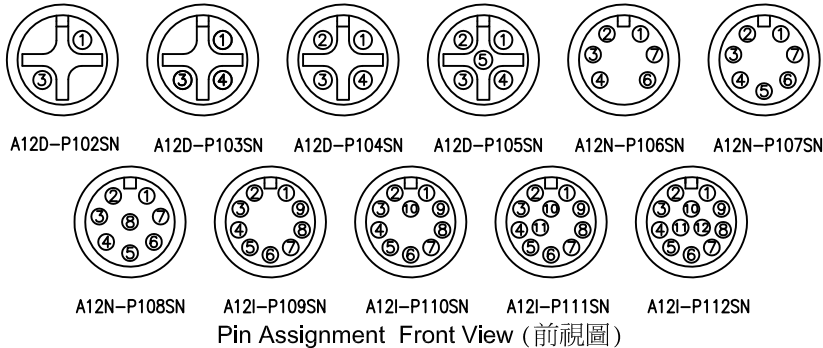

3	RING NUT	NYLON+GF.	BLACK	1	
2	CONTACT	BRASS, 6 u" Gold Plated. Male Contact.		N	
1	CONNECTOR	M12 A-Coding Male Connector Insert. NYLON+GF.	BLACK	1	
No.	PART NAME	DESCRIPTION	COLOR	Q'TY	REMARKS

REV.	DESCRIPTION	DATE
A	ISSUE	Feb/04/2016

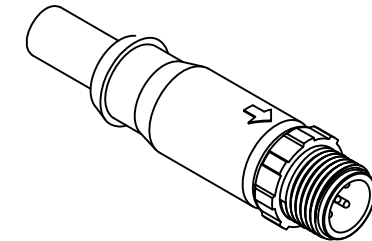

NOTES:

1. ELECTRICAL CHARACTERISTICS:

CURRENT RATING: 1.5A / 2A / 4A

TEMPERATURE RANGE: -20°C TO +80°C

DIELECTRIC WITHSTANDING VOLTAGE:

500V AC FOR ONE MINUTE

2. HOW TO ORDER: A12x-P1xxSN

- 02 - 2 PIN
- 03 - 3 PIN
- 04 - 4 PIN
- 05 - 5 PIN
- 06 - 6 PIN
- 07 - 7 PIN
- 08 - 8 PIN
- 09 - 9 PIN
- 10 - 10 PIN
- 11 - 11 PIN
- 12 - 12 PIN

- I - CURRENT RATING 1.5A
- N - CURRENT RATING 2A
- D - CURRENT RATING 4A

HOLIN<sup>®</sup> HTP ASIA TECHNOLOGY CO., LTD.  
禾凌科技股份有限公司

	UNIT: mm	TITLE: M12 A-Coding Male All Plastics Molded Cable Ass'y
SCALE	1:1	
UNLESS OTHERWISE SPECIFIED TOLERANCES: .X ± 0.5 .XX ± 0.25 .XXX ± 0.1 ANGLE ± 1°		P/N: A12x-P1xxSN
REV. A	SHEET 1/1	DWG.NO: A12x-P1xxSN
		DR. Patty CH. ERIC AP.

RoHS

IP66-68

REV.	DESCRIPTION	DATE
A	ISSUE	Jul/21/2015

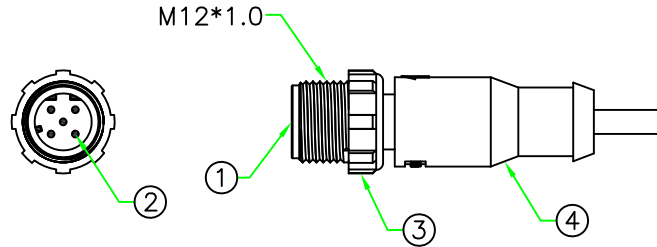
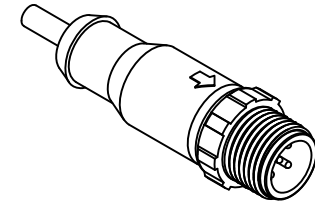
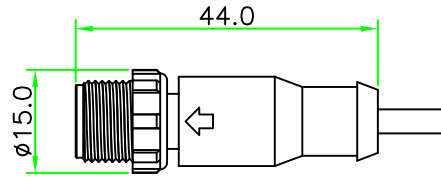

NOTES:

- ELECTRICAL CHARACTERISTICS:  
CURRENT RATING: 4A  
TEMPERATURE RANGE: -20°C TO +80°C  
DIELECTRIC WITHSTANDING VOLTAGE:  
500V AC FOR ONE MINUTE
- HOW TO ORDER: D12D-P1xxSN

- 02 - 2 PIN
- 03 - 3 PIN
- 04 - 4 PIN
- 05 - 5 PIN

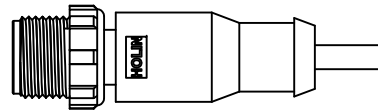

\*Cable specification and length can be customized.

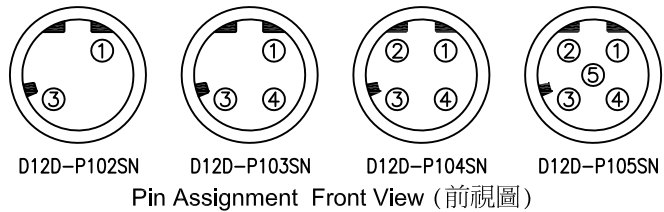

<b>HOLIN®</b> HTP ASIA TECHNOLOGY CO., LTD. 禾凌科技股份有限公司		<b>TITLE:</b> M12 D-Coding Male Connector All Plastic Molded Cable Ass'y	
	<b>UNIT:</b> mm	<b>P/N:</b> D12D-P1xxSN	
<b>SCALE</b>	1:1	<b>DR.</b>	Patty
<b>UNLESS OTHERWISE SPECIFIED TOLERANCES:</b> X ± 0.5    XX ± 0.05 XXX ± 0.1    ANGLE ± 1°		<b>CH.</b>	ERIC
<b>REV.</b>	<b>SHEET</b>	<b>DWG.NO.:</b>	<b>AP.</b>
A	1/1	D12D-P1xxSN	

No.	PART NAME	DESCRIPTION	COLOR	Q'TY	REMARKS
4	OVERMOLD	PU or PVC.	BLACK		
3	RING NUT	NYLON+GF.	BLACK	1	
2	CONTACT	BRASS, 6 u" Gold Plated. Male Contact.		N	
1	CONNECTOR	M12 D-Coding Male Connector Insert. NYLON+GF.	BLACK	1	