

NINA-W15 series

Stand-alone multiradio modules with Wi-Fi and Bluetooth

Data sheet



Abstract

This technical data sheet describes the NINA-W15 series stand-alone multiradio modules. NINA-W15 modules come with pre-flashed application software, Wi-Fi (802.11b/g/n) and Bluetooth dual-mode (Bluetooth BR/EDR and Bluetooth Low Energy). NINA-W15 has several important embedded security features, including secure boot which ensures that only authenticated software can run on the module. The modules are ideal for critical IoT applications where security is important.

Document information

Title	NINA-W15 series	
Subtitle	Stand-alone multiradio modules with Wi-Fi and Bluetooth	
Document type	Data sheet	
Document number	UBX-18006647	
Revision and date	R13	9-Nov-2021
Disclosure restriction	C1-Public	

Product status	Corresponding content status	
Functional sample	Draft	For functional testing. Revised and supplementary data will be published later.
In development / Prototype	Objective specification	Target values. Revised and supplementary data will be published later.
Engineering sample	Advance information	Data based on early testing. Revised and supplementary data will be published later.
Initial production	Early production information	Data from product verification. Revised and supplementary data may be published later.
Mass production / End of life	Production information	Document contains the final product specification.

This document applies to the following products:

Product name	Type number	u-connectXpress software version	Hardware version	PCN reference	Product status
NINA-W151	NINA-W151-03B-01	4.0.0	08	UBX-21043575	Initial production
NINA-W152	NINA-W152-03B-01	4.0.0	08	UBX-21043575	Initial production
NINA-W156	NINA-W156-03B-00	4.0.0	07	N/A	Initial production

u-blox or third parties may hold intellectual property rights in the products, names, logos and designs included in this document. Copying, reproduction, modification or disclosure to third parties of this document or any part thereof is only permitted with the express written permission of u-blox.

The information contained herein is provided "as is" and u-blox assumes no liability for its use. No warranty, either express or implied, is given, including but not limited to, with respect to the accuracy, correctness, reliability and fitness for a particular purpose of the information. This document may be revised by u-blox at any time without notice. For the most recent documents, visit www.u-blox.com.

Copyright © u-blox AG.

Contents

Document information	2
Contents	3
1 Functional description.....	6
1.1 Overview.....	6
1.2 Applications	6
1.3 Block diagram	7
1.4 Product variants.....	7
1.4.1 NINA-W151.....	7
1.4.2 NINA-W152.....	7
1.4.3 NINA-W156.....	7
1.5 Radio performance	8
1.6 Software options.....	8
1.6.1 AT command support.....	8
1.6.2 Software upgrade	8
1.7 IEEE 802.11d and additional regulatory domains.....	9
1.7.1 NINA-W15 IEEE 802.11d implementation description	9
1.8 MAC addresses	10
2 Interfaces	11
2.1 Power supply.....	11
2.1.1 Module supply input (VCC)	11
2.1.2 Digital I/O interfaces reference voltage (VCC_IO).....	11
2.2 Low Power Clock.....	11
2.3 System functions.....	11
2.3.1 Module power on	11
2.3.2 Module power off	12
2.3.3 Module reset	12
2.3.4 ACTIVE mode.....	12
2.3.5 STANDBY mode	12
2.3.6 SLEEP mode	12
2.3.7 STOP mode	13
2.4 Boot strapping pins	13
2.5 RF antenna interface.....	14
2.5.1 Internal antenna.....	14
2.5.2 External RF antenna interface.....	14
2.6 IO signals.....	15
2.6.1 Drive capability.....	15
2.6.2 System status IO signals	15
2.6.3 System control IO signals	15
2.6.4 UART IO signals	15

2.7	Data and command interfaces.....	16
2.7.1	UART	17
2.7.2	RMII.....	17
2.7.3	SPI.....	17
3	Pin definition.....	19
3.1	Pin assignment.....	19
4	Electrical specifications.....	22
4.1	Absolute maximum ratings	22
4.1.1	Maximum ESD ratings.....	22
4.2	Operating conditions.....	22
4.2.1	Operating temperature range.....	23
4.2.2	Supply/Power pins	23
4.2.3	RESET_N pin.....	23
4.2.4	Digital pins.....	23
4.2.5	Current consumption.....	24
4.2.6	Wi-Fi radio characteristics.....	25
4.2.7	Bluetooth radio characteristics	25
4.2.8	Bluetooth low energy characteristics.....	26
4.2.9	Antenna radiation patterns.....	26
5	Mechanical specifications.....	29
5.1	NINA-W151 mechanical specification.....	29
5.2	NINA-W152 mechanical specification.....	30
5.3	NINA-W156 mechanical specification.....	31
6	Qualification and approvals	32
6.1	Country approvals.....	32
6.2	European Union regulatory compliance	32
6.2.1	Radio Equipment Directive (RED) 2014/53/EU	32
6.2.2	Compliance with the RoHS directive	32
6.3	FCC/IC compliance.....	32
6.3.1	FCC compliance	32
6.3.2	FCC statement.....	33
6.3.3	RF exposure statement.....	33
6.3.4	End-product user manual instructions	33
6.3.5	End-product labeling requirements.....	34
6.3.6	End product compliance.....	35
6.4	Japan radio equipment compliance.....	36
6.4.1	Compliance statement.....	36
6.4.2	End product labelling requirement.....	36
6.4.3	End product user manual requirement	36
6.5	NCC Taiwan compliance.....	36
6.5.1	Taiwan NCC warning statement	36
6.5.2	NINA-W151 labeling requirements for end product	37

6.5.3	NINA-W152 labeling requirements for end product	37
6.5.4	NINA-W156 labeling requirements for end product	37
6.6	KCC South Korea compliance.....	37
6.7	Brazil compliance	38
6.8	Australia and New Zealand regulatory compliance	38
6.9	South Africa regulatory compliance	39
6.10	Safety compliance	39
6.11	Bluetooth qualification information	39
7	Antennas	41
7.1	Antenna accessories	42
7.2	Approved antennas	42
7.2.1	Single band antennas	42
7.2.2	Dual-band antennas.....	46
8	Product handling	47
8.1	Packaging	47
8.1.1	Reels	47
8.1.2	Tapes.....	47
8.2	Moisture sensitivity levels.....	49
8.3	Reflow soldering	49
8.4	ESD precautions.....	49
9	Labeling and ordering information	50
9.1	Product labeling.....	50
9.2	Product identifiers	51
9.3	Identification codes	51
9.4	Ordering information.....	51
	Appendix	52
	A Glossary	52
	Related documents	54
	Revision history	55
	Contact.....	57

1 Functional description

1.1 Overview

NINA-W15 series stand-alone multiradio modules integrate Wi-Fi, Bluetooth BR/EDR and Bluetooth low energy in a compact form factor. The modules support simultaneous operation on Wi-Fi and Bluetooth dual-mode and can therefore serve as a gateway between Bluetooth and Wi-Fi or Ethernet.

NINA-W15 modules come with pre-flashed application software, supporting Wi-Fi 802.11b/g/n and dual-mode Bluetooth (Bluetooth BR/EDR v4.2+EDR and Bluetooth Low Energy v4.2) in the 2.4 GHz ISM band. The host system can set up and control the module through the AT command interface.

Intended applications include telematics, industrial automation, connected buildings, wireless sensors, point-of-sales, and medical devices.

NINA-W15 is assessed to comply with RED and is certified as a modular transmitter in the following countries: US (FCC), Canada (IC/ISED RSS), Japan (MIC), Taiwan (NCC), South Korea (KCC), Australia / New Zealand (ACMA), Brazil (Anatel), South Africa (ICASA). The modules are qualified for professional grade operation, supporting an extended temperature range of $-40\text{ }^{\circ}\text{C}$ to $+85\text{ }^{\circ}\text{C}$.

1.2 Applications

- Internet of Things (IoT)
- Wi-Fi and Bluetooth networks
- Telematics
- Point-of-sales
- Medical and industrial networking
- Access to laptops, mobile phones, and similar consumer devices
- Home/building automation
- Ethernet/Wireless Gateway

1.3 Block diagram

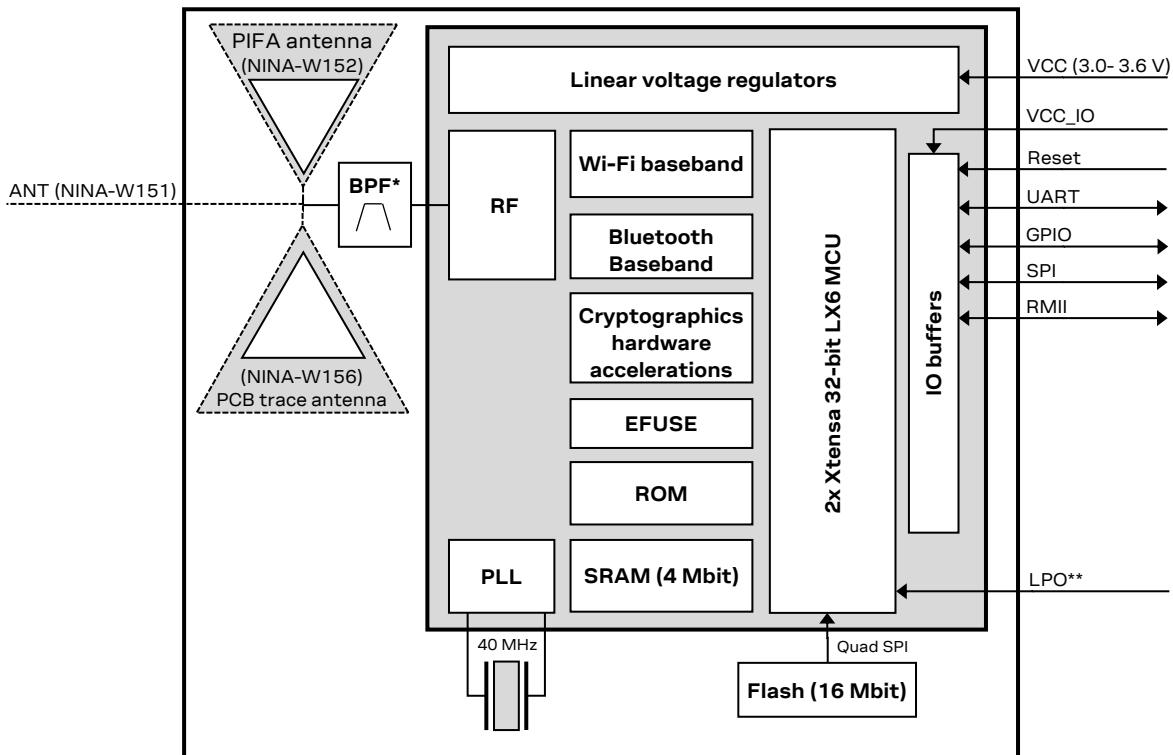

* Only on NINA-W151 and NINA-W152

** Only on NINA-W156

Figure 1: Block diagram of NINA-W15 series

External LPO is a planned feature for NINA-W156 and is not supported in the current software.

1.4 Product variants

NINA-W15 series modules come with pre-flashed application software, supporting Wi-Fi 802.11b/g/n, Bluetooth BR/EDR and Bluetooth Low Energy v4.2 in the 2.4 GHz ISM band. The host system can set up and control the module through the AT command interface. See also the u-connectXpress AT commands manual [3].

1.4.1 NINA-W151

NINA-W151 has no internal antenna. Instead, the RF signal is available at a module pin for routing to an external antenna or antenna connector. The module outline is smaller compared to the module variants with antenna, only 10.0 x 10.6 mm. The module height is 2.2 mm.

1.4.2 NINA-W152

NINA-W152 has an internal PIFA antenna mounted on the module. The RF signal is not connected to any module pin. The module outline is 10.0 x 14.0 mm and the height 3.8 mm.

1.4.3 NINA-W156

NINA-W156 has an internal PCB trace antenna, using antenna technology licensed from ProAnt AB. The RF signal is not connected to any module pin. The module outline is 10.0 x 14.0 mm and the height 2.2 mm.

1.5 Radio performance

NINA-W15 modules support Wi-Fi and conform to IEEE 802.11b/g/n single-band 2.4 GHz operation, Bluetooth BR/EDR and Bluetooth Low Energy, as explained in Table 1.

Wi-Fi	Bluetooth BR/EDR	Bluetooth Low Energy
IEEE 802.11b/g/n IEEE 802.11d	Bluetooth v4.2+EDR Maximum number of Peripherals: 5	Bluetooth 4.2 Bluetooth LE dual-mode
Band support Station mode: 2.4 GHz, channel 1-13* Access Point mode: 2.4 GHz, channel 1-11	Band support 2.4 GHz, 79 channels	Band support 2.4 GHz, 40 channels
Typical conducted output power 15 dBm	Typical conducted output power - 1 Mbit/s: 5 dBm - 2/3 Mbit/s: 5 dBm	Typical conducted output power 5 dBm
Typical radiated output power 18 dBm EIRP**	Typical radiated output power - 1 Mbit/s: 8 dBm EIRP** - 2/3 Mbit/s: 8 dBm EIRP**	Typical radiated output power 8 dBm EIRP**
Conducted sensitivity -96 dBm	Conducted sensitivity -88 dBm	Conducted sensitivity -88 dBm
Data rates: IEEE 802.11b: 1 / 2 / 5.5 / 11 Mbit/s IEEE 802.11g: 6 / 9 / 12 / 18 / 24 / 36 / 48 / 54 Mbit/s IEEE 802.11n: MCS 0-7, HT20 (6.5-72 Mbit/s)	Data rates: 1 / 2 / 3 Mbit/s	Data rates: 1 Mbit/s

* Maximum support for 802.11d depends on the region.

** RF power including maximum antenna gain (3 dBi).

Table 1: NINA-W15 series Wi-Fi and Bluetooth characteristics

1.6 Software options

NINA-W15 series modules come with the pre-flashed application software, supporting IEEE 802.11b/g/n single-band 2.4 GHz operation, Bluetooth BR/EDR and dual-mode Bluetooth. The host system can set up and control the module through the AT command interface. NINA-W15 modules provide top grade security, thanks to secure boot, which ensures the module boots up only with original u-blox software. The modules additionally provide end-to-end security on the wireless link with the latest 802.11i (WPA2/WPA3) standard and enterprise security that provides a secure connection to the infrastructure. This makes NINA-W15 ideal for critical IoT applications where security is important.

1.6.1 AT command support

You configure the NINA-W151, NINA-W152 and NINA-W156 modules with the u-blox s-center toolbox software using AT commands. See also the u-connectXpress AT commands manual [3].

The s-center evaluation software supporting the AT commands is available free of charge and can be downloaded from the u-blox website.

1.6.2 Software upgrade

Information on how to upgrade the software for the NINA-W15 series is provided in the NINA-W1 series system integration manual [1].

1.7 IEEE 802.11d and additional regulatory domains

NINA-W15 series modules support the IEEE 802.11d wireless network standard, which extends the original IEEE 802.11 specification to include support for “additional regulatory domains”.

NINA-W15-based devices configure automatically to operate in accordance regulatory domains.

By passively scanning (listening) for beacons available wireless networks, NINA-W15 modules identify the channels supported by each network and determine the best access point with which to connect. The modules configure automatically to operate in accordance with the policies and regulations of the regional domain in which they operate.

Passive scans are performed once on startup and then once every hour. After the first passive scan the channel list will be filtered to according to 802.11d.

1.7.1 NINA-W15 IEEE 802.11d implementation description

When used as Wi-Fi stations, NINA-W1 modules passively scan access point (AP) beacons at start-up. A new scan is performed every hour to update the regulatory domain. The algorithm is restarted when the module is turned on or reset. It is not possible to override the algorithm described by reconfiguring the device.

The beacons include information elements that describe the country name, data rates, channel quantity, signal strength, and maximum transmission level of the wireless network that they represent. Based on the information received from the beacons, the modules compare APs and choose which one to use. NINA-W1 modules configure automatically to operate on all bands supported in the regulatory domain of the chosen AP, as shown in Table 2.

NINA-W15 supports the following three domains:

- **FCC:** This is the regulatory body for products used in the US. If the scan results include country information pertaining solely to the FCC the regulatory domain is set to FCC.
- **ETSI:** This is the regulatory domain for the products sold primarily in Europe. If at least three scan results contain country information pertaining to non-FCC countries, and no other contrary information is received, the regulatory domain is set to ETSI.
- **WORLD:** In this domain, NINA-W1 modules operate on all channels supported both by FCC, ETSI, and most other countries in the world. This is the initial regulatory domain. If subsequent scans contain country information for both FCC and non-FCC countries, the regulatory domain is always set to WORLD. In Figure 2, this state is shown as WORLD-FINAL. This state is not exited until the device is reset.

The state transition diagram shown in Figure 2 describes the algorithm for selecting the current regulatory domain.

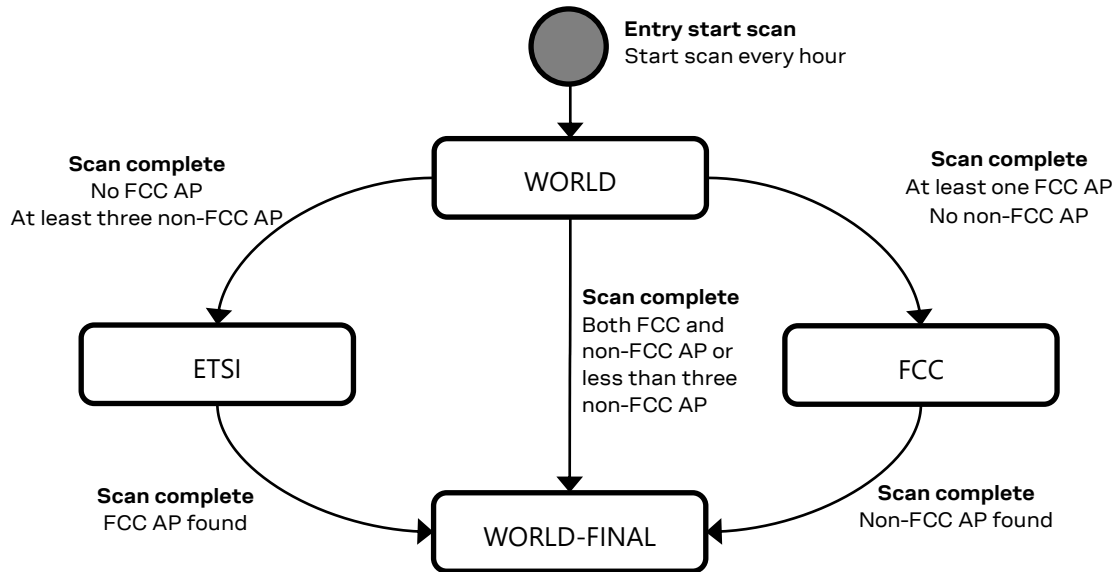

Figure 2: NINA-W15 series IEEE 802.11d state transition diagram

Table 2 shows the channels that are supported in the different regulatory domains.

Regulatory domain	Band	Tx channels
WORLD	2.4 GHz	1, 2, 3, 4, 5, 6, 7, 8, 9, 10, 11
ETSI	2.4 GHz	1, 2, 3, 4, 5, 6, 7, 8, 9, 10, 11, 12, 13
FCC	2.4 GHz	1, 2, 3, 4, 5, 6, 7, 8, 9, 10, 11

Table 2 Channel list for supported regulatory domains

⚠ Channels 12 and 13 are not allowed in Taiwan. A device placed on the Taiwanese market must make these channels unavailable to an end-user. This is done by forcing the module to operate in WORLD mode using the `AT+UWCFG=11,1` command.

The maximum output power is reduced on some channels depending on regulatory requirements. For example, frequency band edge requirements can limit the output power on channels close to band edges.

1.8 MAC addresses

The NINA-W15 module series has four unique consecutive MAC addresses reserved for each module and the addresses are stored in the configuration memory during production. The first Wi-Fi MAC address is available in the Data Matrix on the label. See also [Product labeling](#).

MAC address	Assignment	Last bits of MAC address	Example
Module 1, address 1	Wi-Fi	00	D4:CA:6E:90:04:90
Module 1, address 2	RMII/Ethernet	01	D4:CA:6E:90:04:91
Module 1, address 3	Bluetooth	10	D4:CA:6E:90:04:92
Module 1, address 4	Reserved	11	D4:CA:6E:90:04:93
Module 2, address 1	Wi-Fi	00	D4:CA:6E:90:04:94
Module 2, address 2	RMII/Ethernet	01	D4:CA:6E:90:04:95
Module 2, address 3	Bluetooth	10	D4:CA:6E:90:04:96
Module 2, address 4	Reserved	11	D4:CA:6E:90:04:97

Table 3: Example MAC addresses assignment for two modules

2 Interfaces

2.1 Power supply

The power for NINA-W15 series modules is supplied through **VCC** and **VCC_IO** pins by DC voltage.

 The system power supply circuit must be able to support peak power as during operation, the current drawn from **VCC** and **VCC_IO** can vary significantly based on the power consumption profile of the Wi-Fi technology.

2.1.1 Module supply input (VCC)

NINA-W15 series modules use an integrated Linear Voltage converter to transform the supply voltage presented at the **VCC** pin into a stable system voltage.

2.1.2 Digital I/O interfaces reference voltage (VCC_IO)

All modules in the NINA-W15 series provide an additional voltage supply input for setting the I/O voltage level. The separate **VCC_IO** pin enables integration of the module in many applications with different voltage levels (for example, 1.8 V or 3.3 V) without any level converters. NINA-W15 modules support only 3.3 V as IO voltage level currently.

2.2 Low Power Clock

 External LPO is a planned feature not supported in the current software.

NINA-W15 does not have an internal low power oscillator (LPO), which is required for lowest power modes. An external 32.768 kHz LPO signal can be supplied externally via the **LPO_CLK** pin of the NINA-W156 module if low power modes are required. NINA-W152 and NINA-W151 do not support an external LPO clock.

2.3 System functions

NINA-W15 series modules are power efficient devices capable of operating in different power saving modes and configurations. Different sections of the modules can be powered off when they are not needed, and complex wake up events can be generated from different external and internal inputs.

Sections 2.3.1 to 2.3.7 describe the system power modes, power-on/off, reset behavior, and boot strapping options.

The following system power modes are available:

- Automatic:
 - ACTIVE mode
 - STANDBY mode
- Manual:
 - SLEEP mode
 - STOP mode

2.3.1 Module power on

You can switch on or reboot the NINA-W15 series modules in one of the following ways:

- Rising edge on the VCC pin to a valid supply voltage
- Issuing a reset of the module. See also [Module reset](#).

If the u-connectXpress software has been configured to start in AT mode, `+STARTUP` is sent over the UART interface when the software has booted and is ready to accept commands.

2.3.2 Module power off

There is no dedicated pin to power down the NINA-W15 series modules. Instead, the “STOP” power mode can be used to keep the module in the deepest power save mode. STOP mode is more power efficient than holding the module in reset.

2.3.3 Module reset

NINA-W15 series modules can be reset (rebooted) in any of the following ways:

- **RESET_N** low. Normally set high by an internal pull-up, a logical low state on this signal low causes a “hardware reset” of the module. **RESET_N** should be driven by an open drain, open collector, or contact switch.
- NINA-W15 modules can be reset using the `AT+CPWROFF` command.

Holding the module in reset does not result in the lowest power consumption. For optimal power reduction, set the module in [STOP mode](#).

2.3.4 ACTIVE mode

In this mode the module is actively transmitting or receiving data over one or more of its interfaces; 2.4 GHz radio, UART, and so on. The module CPU is operating at its highest clock speed. The module seamlessly switches between ACTIVE mode and STANDBY automatically without user involvement.

2.3.5 STANDBY mode

In this mode the module “idles” and performs only background activities. As radio and physical connections are maintained, no packets are lost in this mode. When necessary, the module automatically enters ACTIVE mode without delay.

The user can further decrease current consumption in STANDBY mode by:

- Enabling Automatic Frequency Adaption (AFA)
- Increasing the Bluetooth low energy connection interval
- Increase the DTIM listen interval (Wi-Fi Station mode only)
- Storing and sending data in concentrated bursts

Automatic Frequency Adaption (AFA) allows the internal clocks to be automatically reduced whenever possible. AFA is configured using the `AT+UPWRMNG` command.

 Enabling AFA limits the maximum baud rate of the UART interface to 1 Mbaud.

 For more information about the AT commands for configuring u-connectXpress software, see also the u-connectXpress AT commands manual [3] and u-connectXpress software user guide [6].

2.3.6 SLEEP mode

For radio modes that support SLEEP mode, the module operates with even lower power consumption than that required in STANDBY mode.

As the module functionality is limited in this mode, it must be activated manually by the host.

In SLEEP mode, radio and peer connections are maintained, but incoming data or URCs are not sent over the UART until SLEEP mode is deactivated, hence incoming data or URCs may be lost.

Enable SLEEP mode control using command `AT&D3` and toggle the UART **DSR** pin to enter/leave SLEEP mode.

SLEEP mode is supported in the following radio modes:

- Wi-Fi Station
- Radio turned off

To further decrease power consumption in SLEEP mode, the following software settings can be used:

- Enabling Automatic Frequency Adaption (AFA)
- Increasing the Bluetooth Low Energy connection interval
- Increase the DTIM listen interval (Wi-Fi Station mode only)

Enabling AFA can put limits on certain module functions, maximum UART baud rate, and so on. Check the u-connectXpress AT commands manual [3] to determine which clock speeds are appropriate for your application.

See the u-connectXpress AT commands manual [3] and u-connectXpress software user guide [6] for more information on how to use AT commands for configuring the u-connectXpress software.

2.3.7 STOP mode

STOP mode is the deepest power saving mode of NINA-W15 modules. To ensure minimum power consumption during STOP mode, all functionality is stopped and all existing connections are dropped. The system RAM is not retained. The module always reboots during the wake up from STOP mode.

The user must manually enter the STOP mode with one of the following methods:

- Enable STOP mode control using command `AT&D4` and toggle the UART **DSR** pin to enter/leave STOP mode.
- Use command `AT+USTOP` to configure which GPIO pin is used to enter/leave STOP mode. The GPIOs capable of controlling STOP mode are shown in Table 6.
- Use command `AT+USTOP` to configure a timer to automatically wake up after a delay set by the user.

If the u-connectXpress software is configured to start in AT mode, the `+STARTUP` command is sent over the UART interface when the module is ready to accept commands.

For more information on how to use AT commands to configure the u-connectXpress software, see the u-connectXpress AT commands manual [3] and u-connectXpress software user guide [6].

2.4 Boot strapping pins

Table 4 shows boot configuration pins on the module that must be set correctly during boot.

Boot strap pins are configured to their default state internally on the module and generally must NOT be set externally. Exceptionally, pin 32 can be connected to GND to turn off printouts during start-up. After the system has booted, pin 32 is reconfigured to the SPI chip-select signal **SPI_CS**.

Pin 27 is a boot strap pin but is also the RMI clock line. For more information about how to use the RMI interface, see the NINA-W1 series system integration manual [1].

Pin 36 controls the voltage level of the internal flash during startup. After the system has booted this pin is reconfigured as the SPI slave data output signal **SPI_MISO**. This signal must NOT be pulled down by an external MCU or circuitry. After the module has booted, the **RMI_CLK**, **UART_RXD**, **SPI_DRDY** and **SPI_SCLK** are used to determine which command interfaces to activate. See also [Data and command interfaces](#).

Pin	State during boot	Default	Behavior	Description
27	0		ESP boot mode (factory boot)	ESP Factory boot Mode/RMI clock line.
	1	Pull-up*	Normal boot from internal flash	
32	0		Silent	Printout on U0TXD during boot

Pin	State during boot	Default	Behavior	Description
1		Pull-up*	U0TXD toggling	
36	0		VDD_SDIO=3.3 V (not allowed)	Internal flash voltage
1		10 kΩ pull-up	VDD_SDIO=1.8 V (VDD_SDIO should always be at 1.8 V)	

*About 45 kΩ

Table 4: NINA-W15 series boot strapping pins

2.5 RF antenna interface

The RF antenna interface of the NINA-W15 series supports Wi-Fi, Bluetooth BR/EDR and Bluetooth Low Energy on the same antenna. The different communication protocols are time divided on the antenna to switch between the Bluetooth and Wi-Fi data. Although communication using these different protocols generally transparent in the application, these protocols are never active in the module antenna at exactly the same time.

NINA-W15 series modules support either an internal antenna (NINA-W152 and NINA-W156) or an external antenna connected through a dedicated antenna pin (NINA-W151).

2.5.1 Internal antenna

Both NINA-W152 and NINA-W156 have internal antennas specifically designed and optimized for the NINA module. The NINA-W152 module has a 2.4 GHz PIFA antenna and the NINA-W156 module has a 2.4 GHz PCB trace antenna.

It is recommended to place the NINA-W152 modules in such a way that the internal antenna is in the corner of the host PCB (the corner closest to Pin 16 should be in the corner). The antenna side (with the short side closest to the antenna) positioned along one side of the host PCB ground plane is the second-best option.

For the NINA-W156 module, place it in such a way that the PCB trace antenna is placed on the side edge of the host PCB and in the middle of the side.

For both NINA-W152 and NINA-W156, keep a minimum clearance of 5 mm between the antenna and the casing. Keep a minimum of 10 mm free space from the metal around the antenna including the area below. If a metal enclosure is required, use NINA-W151 and an external antenna. It is beneficial to have a large solid ground plane on the host PCB and have a good grounding on the module. Minimum ground plane size is 24x30 mm but recommended is more than 50x50 mm.

See the NINA-W1 series system integration manual [1] for more information about antenna related design.

 The **ANT** signal solder pin is unavailable on NINA-W152 and NINA-W156 modules.

2.5.2 External RF antenna interface

NINA-W151 modules have an antenna signal (**ANT**) pin for use with an external antenna.

An external SMD antenna (or PCB integrated antenna) can be used on the host board, and an antenna connector for using an external antenna through a coaxial cable could also be implemented. A cable antenna might be necessary if the module is mounted in a shielded enclosure such as a metal box or cabinet.

The signal has a characteristic impedance of 50 Ω and supports both Tx and Rx.

An external antenna connector (U.FL. connector) reference design (see NINA-W1 series system integration manual [1]) is available and must be followed to comply with the NINA-W1 FCC/IC modular approvals. See also [Approved antennas](#).

A reference design for use with an external antenna connector (U.FL. connector) is described in NINA W1 system integration manual [1]). The design must be followed to comply with the NINA-W1 FCC/IC modular approvals.

2.6 IO signals

NINA-W15 series modules have a versatile pin-out. Overall, there are up to 16 GPIO pins for NINA-W151/W152 and 18 for NINA-W156.

2.6.1 Drive capability

All GPIO pins are normally configured for medium current consumption. Using this standard drive capability, a pin configured as output can source and an input sink a certain amount of current. See also [Digital pins](#).

2.6.2 System status IO signals

The **RED**, **GREEN** and **BLUE** pins are used to signal the status. They are active low and are intended to be routed to an RGB LED. See u-connectXpress AT commands manual [3] for more information about connectivity software signals IOs.

Mode	Status	RGB LED color	GREEN	BLUE	RED
Data mode	IDLE	Green	LOW	HIGH	HIGH
Command mode	IDLE	Orange	LOW	HIGH	LOW
Data mode, Command mode	CONNECTING*	Purple	HIGH	LOW	LOW
Data mode, Command mode	CONNECTED*	Blue	HIGH	LOW	HIGH

* = LED flashes on data activity

Table 5: System status indication

The **RED**, **GREEN** and **BLUE** signals are disabled when the RMI interface is enabled.

2.6.3 System control IO signals

The following input signals are used to control the system. For more information about connectivity software IO signals, see also the u-connectXpress AT commands manual [3].

- **RESET_N** is used to reset the system. See also [System control IO signals](#).
- If **SWITCH_1** is driven low during start up, the UART serial settings are restored to their default values.
- **SWITCH_2** can be used to open a connection to a peripheral device.
- If both **SWITCH_1** and **SWITCH_2** are driven low during start up, the system will enter the bootloader mode.
- If both **SWITCH_1** and **SWITCH_2** are driven low during start up and held low for 10 seconds, the system will exit the bootloader mode and restore all settings to their factory defaults.

2.6.4 UART IO signals

In addition to the normal **RXD**, **TXD**, **CTS**, and **RTS** signals, the NINA-W15 software adds the **DSR** and **DTR** pins to the UART interface. Although not used as they were originally intended, these pins control the state of the NINA-W15 module.

Depending on the prevailing configuration, the **DSR pin** can be used to:

- Enter command mode
- Disconnect and/or toggle connectable status
- Enable/disable the rest of the UART interface

- Enter/leave SLEEP mode
- Enter/leave STOP mode

If CTS/RTS flow control is disabled, those pins can be used as GPIOs.

2.7 Data and command interfaces

Although there are three data interfaces available on a NINA-W15 module (UART, RMII, and SPI), these cannot be used at the same time. AT commands are used to enable or disable the interfaces manually.

After the module has booted, the module checks for activity on each interface to determine which one should be used. Figure 3 shows the startup and interface selection procedure.

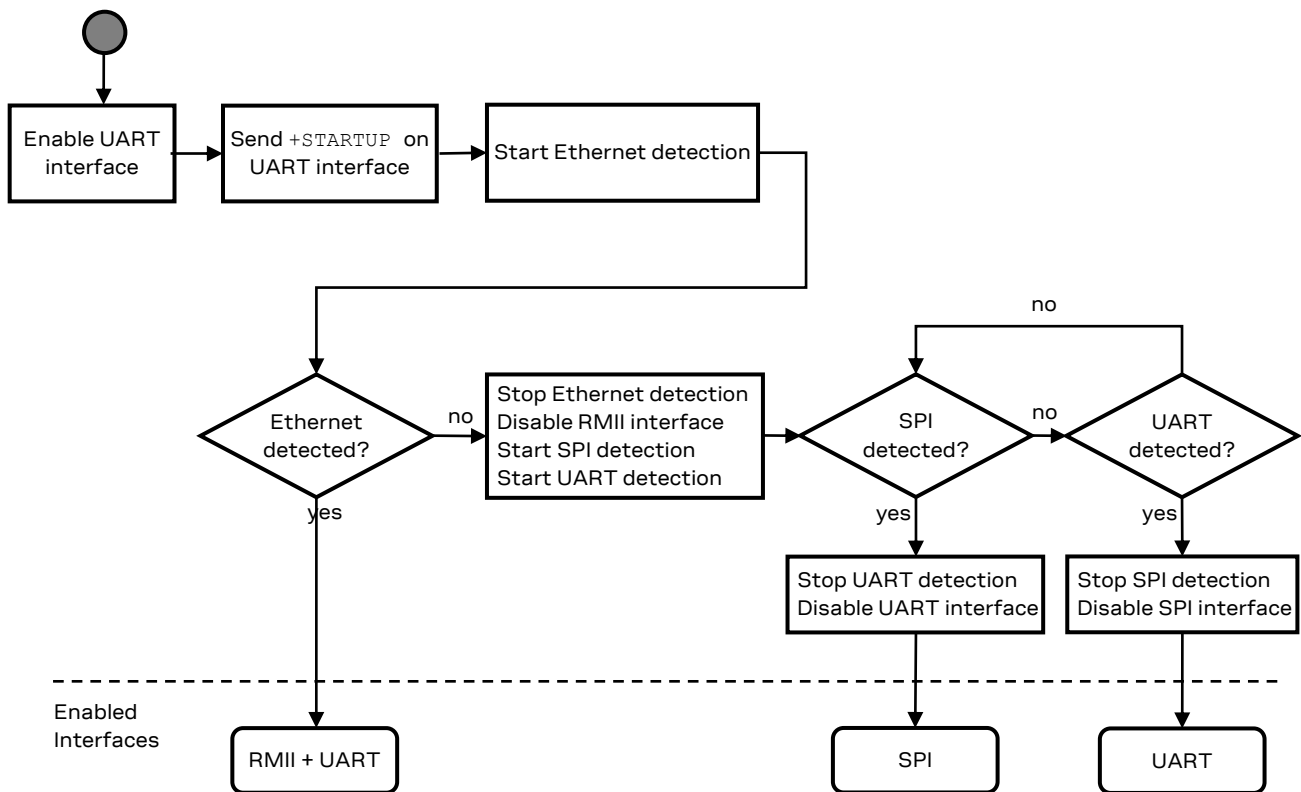

Figure 3: Interface detection flow chart

This process is active until an interface is successfully detected.

+STARTUP is always printed on the UART TXD line.

During Ethernet detection, the NINA-W15 module looks for a clock signal on **RMII_CLK**. If Ethernet is detected, only the **UART_RXD** and **UART_TXD** signals are available on the UART interface.

If SPI detection is started, the NINA-W15 module toggles the **SPI_DRDY** signal periodically. Once the SPI master has sent eight clock signals on the **SPI_SCLK** line, the SPI interface is considered active and the UART interface is subsequently disabled.

If an AT command is sent to the NINA-W15 module over the UART interface, the **SPI_DRDY** signal stops toggling, and the SPI interface is disabled.

For more information about these data and command interfaces, see also the u-connectXpress software user guide [6].

2.7.1 UART

NINA-W15 modules include a 6-wire UART for communication with an application host processor (AT commands, data communication, and software upgrades).

The following UART signals are available:

- Data lines (**RXD** as input, **TXD** as output)
- Hardware flow control lines (**CTS** as input, **RTS** as output)
- Link status (**DTR** as output, **DSR** as input). **DTR/DSR** signal behavior is adapted to the u-connectXpress software functionality and differs from the UART standard. For more information about this, see [UART IO signals](#).
- Programmable baud-rate generator allows most industry standard rates, as well as non-standard rates up to 3 Mbit/s.
- Frame format configuration:
 - 8 data bits
 - Even or no-parity bit
 - 1 stop bit
- Default frame configuration is 8N1 means eight (8) data bits, no (N) parity bit, and one (1) stop bit.

2.7.2 RMII

The RMII (Reduced Media Independent Interface) Ethernet interface is intended for connecting to an external PHY. The following signals are used:

- **RMII_TXD0, RMII_TXD1** – Transmit data output bits 0 and 1.
- **RMII_TXEN** – Output signal used to indicate when data is being transmitted.
- **RMII_RXD0, RMII_RXD1** – Receive data input bits 0 and 1.
- **RMII_CRSDV** – Carrier sense and RX data valid in signals, multiplexed on alternate clock cycles.
- **RMII_CLK** – 50 MHz clock input signal that must be supplied by an external oscillator or the Ethernet PHY chip.

An MDIO (Management Data Input/Output) interface used for controlling the external PHY is also available:

- **RMII_MDCLK** – Management interface clock output signal
- **RMII_MDIO** – Management interface data input and output signal

The flow control (**RTS** and **CTS**) of the UART interface is multiplexed with the RMII interface and cannot be used simultaneously. The **RED**, **GREEN** and **BLUE** signals are also disabled when the RMII interface is enabled because the **BLUE** signal is multiplexed with the RMII interface.

See NINA-W1 series system integration manual [1] for more information about how to use the RMII interface.

2.7.3 SPI

The serial peripheral interface of NINA-W15 only runs in “SPI slave mode”, meaning a host controller running in “SPI master mode” is intended to send commands to the NINA module.

The following signals are used:

- **SPI_SCLK** – Serial clock input signal
- **SPI_MOSI** – Serial data input signal
- **SPI_MISO** – Serial data output signal
- **SPI_CS** – Chip Select input, enable control signal

- **SPI_DRDY** – (optional) Additional “Data Ready” output signal, used to indicate to the controller when data is available. This signal can be disabled but is enabled by default.
- **SPI_NORX** – (optional) Additional flow control output signal used to indicate when the NINA module cannot receive any more data. This signal is not enabled by default.

An SPI master must comply with the following:

- 10 MHz maximum clock speed
- SPI mode 1 or 3
- The SPI master must clock at least 8 bytes minimum and 4096 bytes maximum per transaction, and transaction lengths must be on 4 byte boundary



See the following application note for more information on how to use the SPI interface [7].

3 Pin definition

3.1 Pin assignment

Figure 4 shows the pin configuration used in the NINA-W15 series u-connectXpress modules.

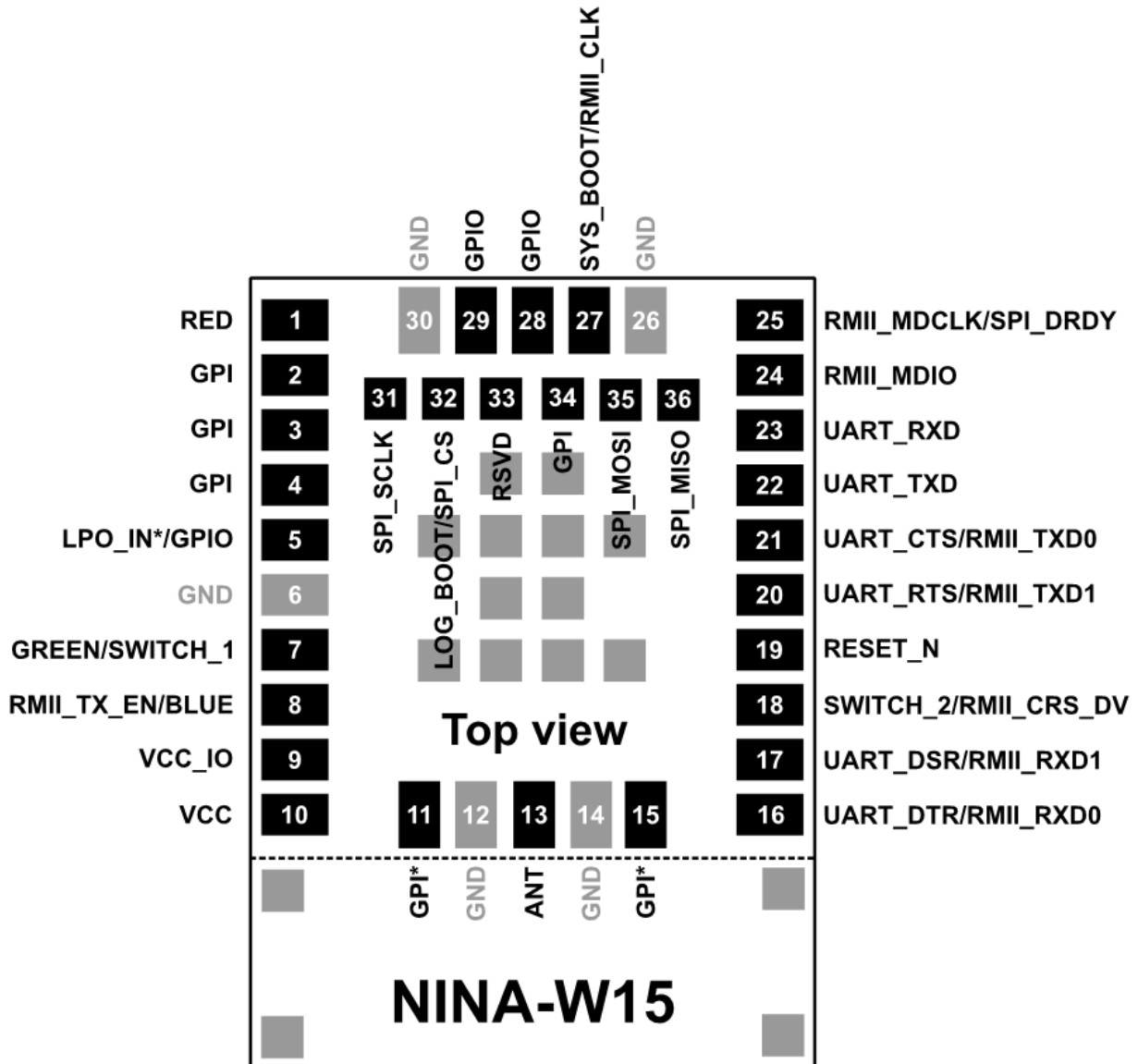

*Only for NINA-W156

Figure 4: NINA-W15 pin assignment (top view)

The grey pins in the center of the modules are GND pins. The outline of NINA-W151 is limited by the dotted line. The lower part is the antenna area of NINA-W152/W156. The four grey pins in the antenna area are only present on NINA-W156.

Some of the signals are bootstrap signals, as described in Table 6. It is important that these signals are in the correct state during startup. See also [IO signals](#).

External LPO (**LPO_IN**) is a planned feature not supported in the current software.

Pin	Name	I/O	Description	Alt. function	Remarks
1	RED	O	Logic Red LED Signal		See also System status IO signals
2	GPI_2	I	General Purpose Input	WKUP_2	Can control STOP mode
3	GPI_3	I	General Purpose Input	WKUP_3	Can control STOP mode
4	GPI_4	I	General Purpose Input	WKUP_4	Can control STOP mode
5	LPO_IN/ GPIO_5	I I/O	Low Power Oscillator Input General Purpose Input /Output		LPO_IN is only supported on NINA-W156.
6	GND		Ground		
7	GREEN/ SWITCH_1	I/O	GREEN: System status signal / SWITCH_1: Multiple functions		Active low. See also System status IO signals , System control IO signals and RMII .
8	BLUE/ RMII_TXEN	O	Logic Blue LED Signal/ RMII Transmit Enable output		See also System status IO signals and RMII .
9	VCC_IO	I	Module I/O level voltage input		IO voltage supply
10	VCC	I	Module supply voltage input		Module voltage supply
11	GPI_11	I	General Purpose Input		GPI only for NINA-W156. For NINA-W151/W152 do not connect.
12	GND		Ground		
13	ANT	I/O	NINA-W151: Antenna Tx/Rx interface		50 Ω nominal characteristic impedance
14	GND		Ground		
15	GPI_15	I	General Purpose Input		GPI only for NINA-W156. For NINA-W151/W152 do not connect.
16	UART_DTR/ RMII_RXD0	I/O	UART Data Terminal Ready/ RMII Receive Data input 0		The DTR signaling is not according to UART standard. See also UART IO signals and RMII .
17	UART_DSR/ RMII_RXD1	I	UART Data Set Ready/ RMII Receive Data input 1		The DSR signaling is not according to UART standard. See also UART IO signals and RMII .
18	SWITCH_2/ RMII_CRSDV	I	SWITCH_2: Multiple functions RMII_CRSDV: Carrier Sense/Receive Data Valid input	WKUP_18	Active low. Can control STOP mode. See also System control IO signals and RMII .
19	RESET_N	I	External system reset input		Active low
20	UART_RTS/ RMII_TXD1	O	UART request to send/ RMII Transmit Data output 1	GPIO_20	Active low See also UART IO signals and RMII .
21	UART_CTS/ RMII_TXD0	I/O	UART clear to send/ RMII Transmit Data output 0	GPIO_21	Active low See also UART IO signals and RMII .
22	UART_TXD	O	UART data output		See also UART
23	UART_RXD	I	UART data input		See also UART
24	RMII_MDIO	I/O	RMII Management data	GPIO_24	See also RMII
25	RMII_MDCLK/ SPI_DRDY	O	RMII Management data Clock/ SPI data ready output	GPO_25	See also RMII
26	GND		Ground		
27	RMII_CLK/ SYS_BOOT	I/O	RMII clock input/ Boot Mode	GPO_27	Default pulled-up. Bootstrap pin. See also Boot strapping pins and RMII .
28	GPIO_28	I/O	General Purpose Input /Output		
29	GPIO_29	I/O	General Purpose Input /Output		
30	GND		Ground		
31	SPI_SCLK	I	SPI clock input signal	GPIO_31 WKUP_31	Can control STOP mode. See also SPI .
32	LOG_BOOT/ SPI_CS	I/O	Debug printout on UART enable/ SPI chip select signal	GPIO_32	Default pulled-up. Bootstrap pin. See also Boot strapping pins and SPI .

Pin	Name	I/O	Description	Alt. function	Remarks
33	RSVD		Reserved for future use		Do not connect
34	GPI_34	I	General Purpose Input	WKUP_34	Can control Stop mode.
35	SPI_MOSI	I	SPI serial data in signal	GPIO_35 WKUP_35	Can control Stop mode. See also SPI .
36	SPI_MISO	O	SPI serial data out signal	GPO_36	Default pulled-up. Bootstrap pin. See also Boot strapping pins and SPI .

Table 6: NINA-W151/NINA-W152/NINA-W156 pinout

4 Electrical specifications

Stressing the device above one or more of the [Absolute maximum ratings](#) can cause permanent damage. These are stress ratings only. Operating the module at these or any conditions other than those specified in the [Operating conditions](#) should be avoided. Exposure to absolute maximum rating conditions for extended periods may affect device reliability.

Where application information is given, it is advisory only and does not form part of the specification.

4.1 Absolute maximum ratings

Symbol	Description	Condition	Min	Max	Unit
VCC/ VCC_IO	Module supply voltage	Input DC voltage at VCC and VCC_IO pins	-0.3	3.6	V
$I_{VCC\ MAX} + I_{VCC_IO\ MAX}$	Absolute maximum power consumption			500	mA
DPV	Digital pin voltage	Input DC voltage at any digital I/O pin	-0.3	3.6	V
P_ANT	Maximum power at receiver	Input RF power at antenna pin		0	dBm
Tstr	Storage temperature		-40	+85	°C

Table 7: Absolute maximum ratings

The product is not protected against overvoltage or reversed voltages. If necessary, voltage spikes exceeding the power supply voltage specification, given in table above, must be limited to values within the specified boundaries by using appropriate protection devices.

4.1.1 Maximum ESD ratings

Parameter	Min.	Typical	Max.	Unit	Remarks
ESD immunity			±8*	kV	Indirect discharge according to IEC 61000-4-2
ESD sensitivity, tested for all pins except GPI or RSVD and ANT pins #11, #15, #13			2.0	kV	Human body model according to JEDEC JS001

* Tested on EVK-NINA-W1 evaluation board.

Table 8: Maximum ESD ratings

NINA-W15 series modules are Electrostatic Sensitive Devices and require special precautions while handling. See also [ESD precautions](#).

4.2 Operating conditions

Operation beyond the specified operating conditions is not recommended and extended exposure beyond them may affect device reliability.

Unless otherwise specified, all operating condition specifications are at an ambient temperature of 25 °C and at a supply voltage of 3.3 V.

4.2.1 Operating temperature range

Parameter	Min	Max	Unit
Operating temperature	-40*	+85	°C

* See also the voltage supply conditions for the lowest temperature range of [Supply/Power pins](#).

Table 9: Temperature range

4.2.2 Supply/Power pins

Symbol	Parameter	Condition	Min	Typ	Max	Unit
VCC	Input supply voltage	Ambient temperature -20 °C to +85 °C	3.00	3.30	3.60	V
		Ambient temperature -40 °C to +85 °C	3.00	3.30	3.45	V
VCC_IO	I/O reference voltage	Ambient temperature -20 °C to +85 °C	3.00	3.30	3.60	V
		Ambient temperature -40 °C to +85 °C	3.00	3.30	3.45	V

Table 10: Input characteristics of voltage supply pins

4.2.3 RESET_N pin

Pin name	Parameter	Min	Typ	Max	Unit
RESET_N	Low-level input	0		0.3*VCC	V
	Internal pull-up resistance		100		kΩ
	Internal capacitance		10		nF
t_Startup	Startup time after release of reset		2.6		s

Table 11: RESET_N pin characteristics

4.2.4 Digital pins

Pin name	Parameter	Min	Typ	Max	Unit	Remarks
Any digital pin	Input characteristic: Low-level input	0		0.3*VCC_IO	V	
	Input characteristic: high-level input	0.7*VCC_IO		VCC_IO	V	
	Output characteristic: Low-level output	0		0.4	V	
	Output characteristic: High-level output	VCC_IO-0.4		VCC_IO	V	
	Drive capability			12	mA	Source/Sink
	Pull-up/pull-down resistance		45		kΩ.	

Table 12: Digital pin characteristics

4.2.5 Current consumption

Table 13 shows the typical current consumption for NINA-W15 modules using u-connectXpress v4.0.0 software. Unless stated otherwise, the module is powered at 3.3 V and uses factory default configurations.

Radio mode	Activity	Power mode	Role	Typ	Unit	Remarks	
Wi-Fi to UART	Transmitting	ACTIVE	AP	120	mA	Data throughput 1 Mbit/s	
			Station	120	mA	Data throughput 1 Mbit/s	
	Receiving	ACTIVE	AP	110	mA	Data throughput 1 Mbit/s	
			Station	110	mA	Data throughput 1 Mbit/s	
	Connected	STANDBY*	AP	100	mA		
			Station	30	mA		
		SLEEP*	AP	100	mA		
			Station	3.5	mA		
Wi-Fi to RMII	Transmitting (15 dBm)	ACTIVE	AP	170	mA		
			Station	130	mA		
	Receiving	ACTIVE	AP	125	mA		
			Station	115	mA		
	Connected	STANDBY	AP	115	mA		
			Station	40	mA		
	Bluetooth BR/EDR (Bluetooth LE disabled)	Transmitting	ACTIVE	Peripheral/Central	150	mA	Data throughput 1.25 Mbit/s
		Receiving	ACTIVE	Peripheral/Central	110	mA	Data throughput 1.25 Mbit/s
Connected		STANDBY**	Peripheral/Central	100	mA		
Inquiry		ACTIVE	-	100	mA		
Bluetooth LE	Transmitting	ACTIVE	Peripheral/Central	60	mA	Data throughput 30 kbit/s	
				80	mA	Data throughput 180 kbit/s	
	Receiving	ACTIVE	Peripheral/Central	50	mA	Data throughput 30 kbit/s	
				60	mA	Data throughput 180 kbit/s	
	Connected	STANDBY**	Peripheral	35	mA		
			Central	35	mA		
	Advertising	STANDBY**	Peripheral	30	mA		
	Discovery	ACTIVE	Central	100	mA		
	Idle	STANDBY**	Central	60	mA	Not connected	
	Disabled	None	STANDBY*	-	30	mA	
SLEEP*			-	1.5	mA		
STOP*			-	5	uA		
Reset		Reset	-	35	uA	Module held in reset	

Table 13: Current consumption during typical use cases

*AFA enabled, minimum allowed clock speed set to 80 MHz, and Wi-Fi Station beacon listen interval set to 10.

**AFA enabled, minimum allowed clock speed set to 80 MHz.

4.2.6 Wi-Fi radio characteristics

Parameter	Operation mode		Specification	Unit		
RF Frequency Range	802.11b/g/n		2.400 – 2.4835	GHz		
Channels			1-13*			
Modulation	802.11b		CCK and DSSS			
	802.11g/n		OFDM			
Supported Data Rates	802.11b		1, 2, 5.5, 11	Mbit/s		
	802.11g		6, 9, 12, 18, 24, 36, 48, 54	Mbit/s		
	802.11n		MCS0 – MCS7			
Supported Bandwidth	802.11n		20	MHz		
Supported Guard Interval	802.11n		400, 800	ns		
Conducted Transmit Power (typical)	802.11b	Channel 6	1 Mbit/s	13** ± 1	dBm	
			11 Mbit/s	13** ± 1	dBm	
	802.11g	Channel 6	6 Mbit/s	15** ± 1	dBm	
			54 Mbit/s	12** ± 1	dBm	
	802.11n	Channel 6	MCS0	15** ± 1	dBm	
			MCS7	11** ± 1	dBm	
	Receiver Sensitivity (typical)	802.11b		1 Mbit/s	-96 ± 2	dBm
				11 Mbit/s	-88 ± 2	dBm
802.11g			6 Mbit/s	-92 ± 2	dBm	
			54 Mbit/s	-74 ± 2	dBm	
802.11n		20 MHz	MCS0	-91 ± 2	dBm	
			MCS7	-72 ± 2	dBm	

Characteristics assume VCC = 3.3 V, Tamb = 25 °C

* Maximum support for 802.11d depends on the region.

** There is lower output power on band edge channels and also on the highest data rates.

Table 14: Wi-Fi radio characteristics

4.2.7 Bluetooth radio characteristics

Parameter	Operation mode		Specification	Unit
RF Frequency Range			2.400 – 2.4835	GHz
Supported Modes			Bluetooth v4.2+EDR	
Number of channels			79	
Modulation	1 Mbit/s		GFSK (BDR)	
	2 Mbit/s		$\pi/4$ -DQPSK (EDR)	
	3 Mbit/s		8-DPSK (EDR)	
Conducted Transmit Power (typical)	1 Mbit/s		5 ± 1	dBm
	2 / 3 Mbit/s		5 ± 1	dBm
Receiver Sensitivity (typical)	1 Mbit/s		-88 ± 2	dBm
	2 Mbit/s		-86 ± 2	dBm
	3 Mbit/s		-80 ± 2	dBm

Characteristics assume VCC = 3.3 V, Tamb = 25 °C

Table 15: Bluetooth radio characteristics

4.2.8 Bluetooth low energy characteristics

$V_{CC} = 3.3\text{ V}$, $T_{amb} = 25\text{ }^{\circ}\text{C}$

Parameter	Specification	Unit
RF Frequency Range	2.400 – 2.4835	GHz
Supported Modes	Bluetooth v4.2	
Number of channels	40	
Modulation	GFSK	
Transmit Power (typical)	5 ± 1	dBm
Receiver Sensitivity (typical)	-88 ± 2	dBm

Table 16: Bluetooth Low Energy characteristics

4.2.9 Antenna radiation patterns

The radiation patterns displayed in Table 17 and Table 18 show the radiation patterns of the NINA-W152 with internal PIFA antenna and the NINA-W156 with internal PCB trace antenna.

Figure 5 gives an overview of the measurement procedure, and how the NINA-W152/NINA-W156 module is aligned to the XYZ-coordinate system. The procedure requires measurements to be taken in all positions shown as dots (left), with the subsequent measurements represented as grid points in the radiation pattern (right).

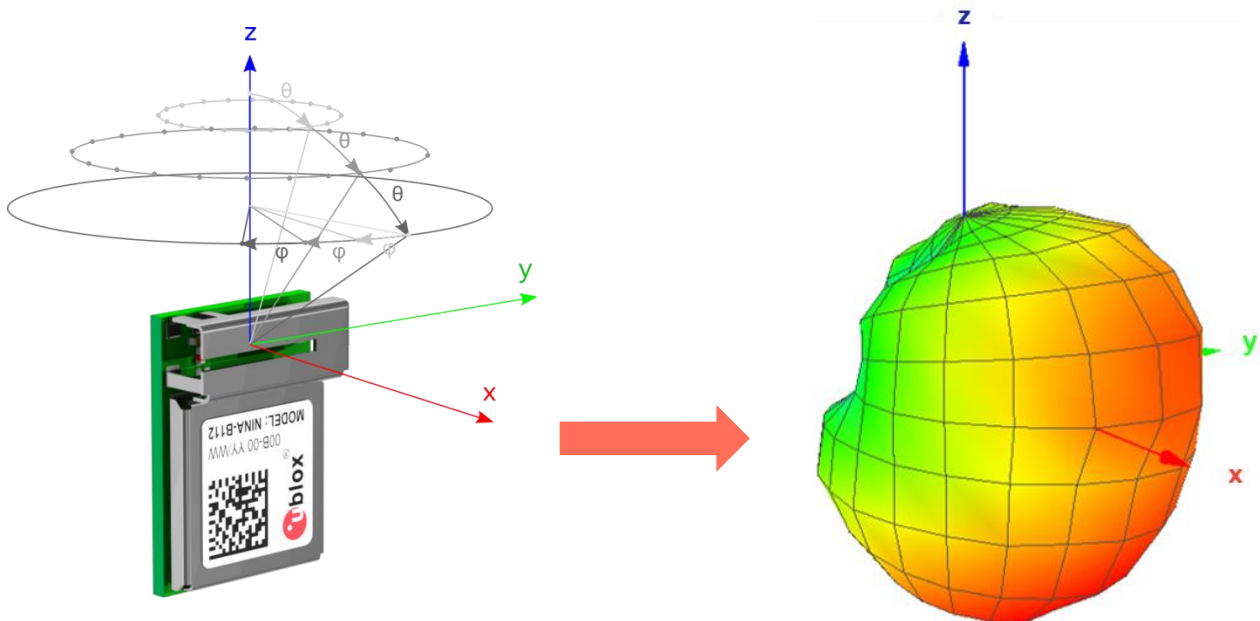
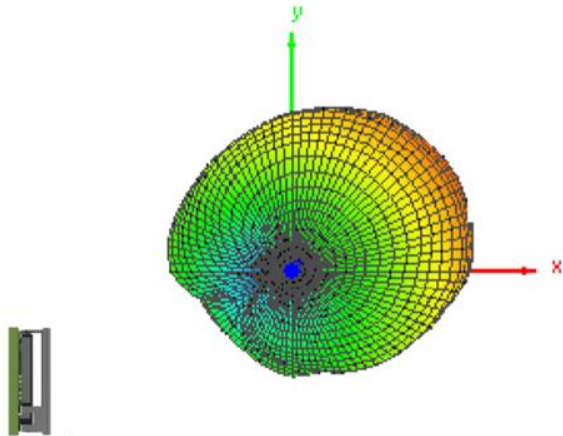
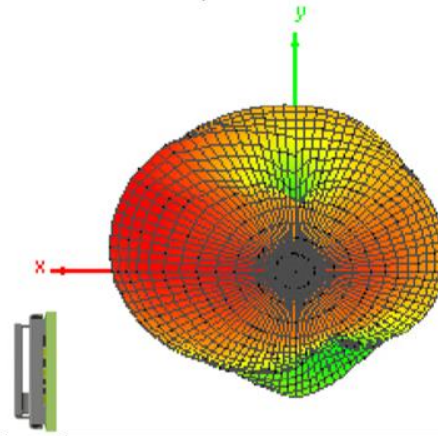

Figure 5: Measurement procedure for determining radiation patterns

Theta = 0, Phi = 0



Theta = 180, Phi = 0



Theta = 90, Phi = 0

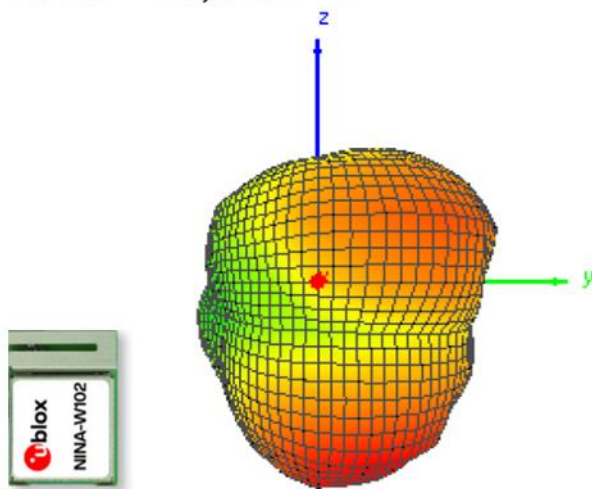

Theta = 90, Phi = 180

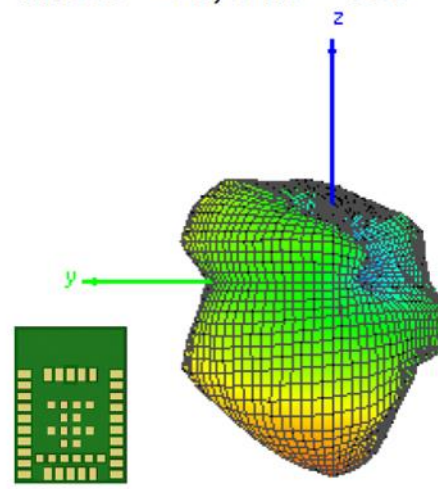

Theta = 90, Phi = 270

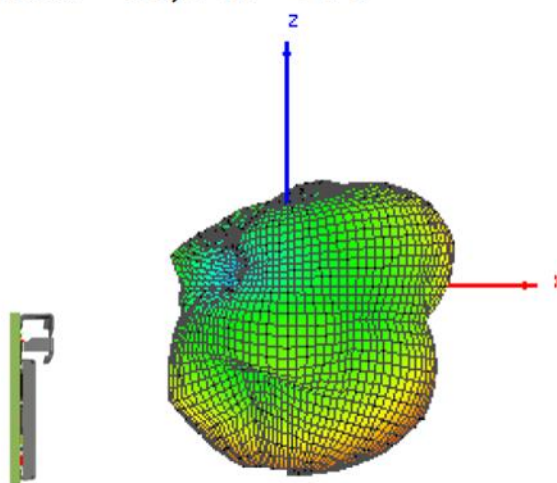

Theta = 90, Phi = 90

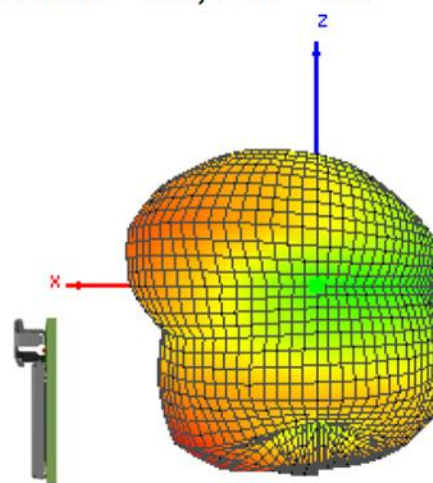
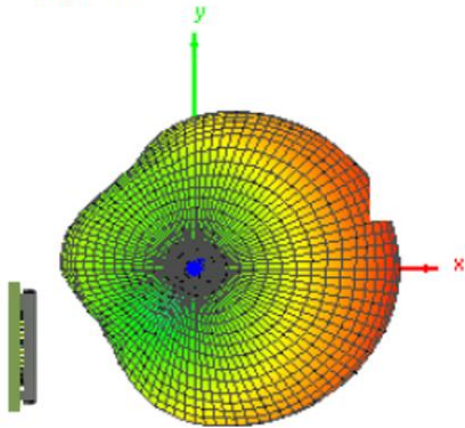
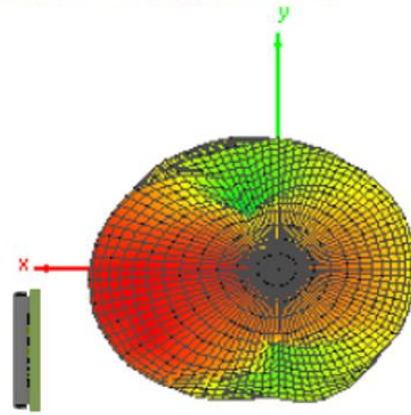

Table 17: NINA-W152 antenna radiation patterns

Theta = 0, Phi = 0



Theta = 180, Phi = 0



Theta = 90, Phi = 0

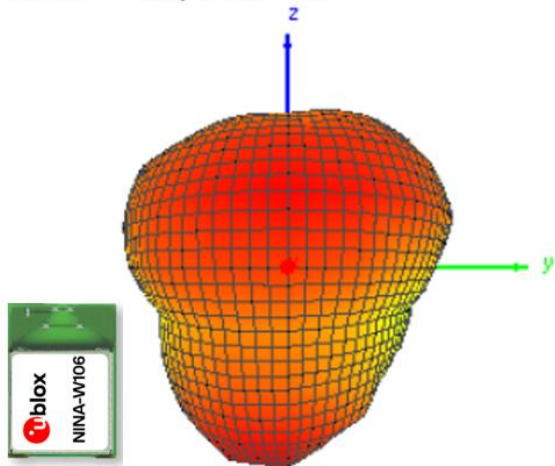

Theta = 90, Phi = 180

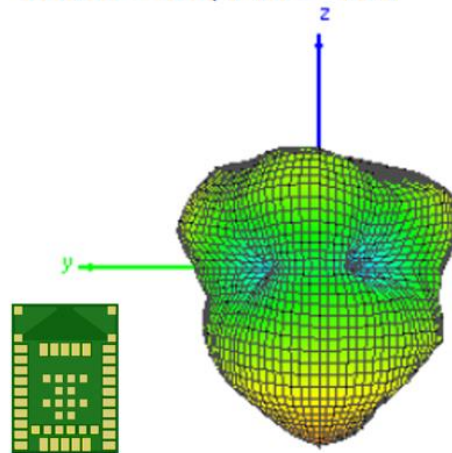

Theta = 90, Phi = 270

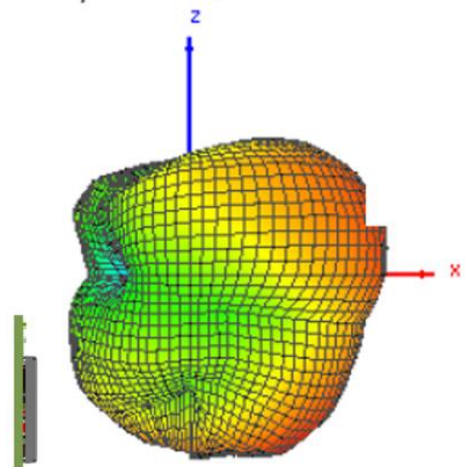

Theta = 90, Phi = 90

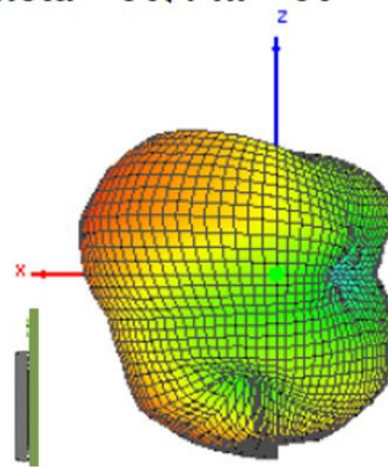

Table 18: NINA-W156 antenna radiation patterns

5 Mechanical specifications

5.1 NINA-W151 mechanical specification

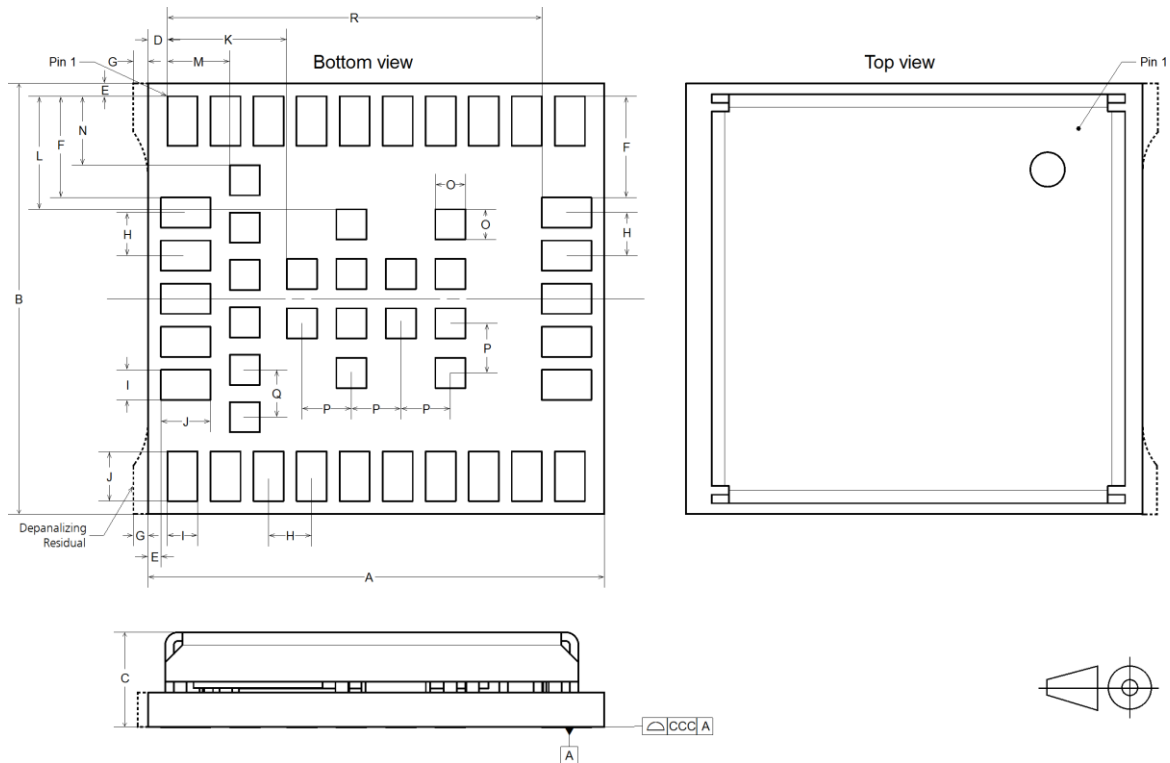

Figure 6: NINA-W151 mechanical outline

Parameter	Description	Typical		Tolerance
A	Module PCB length [mm]	10.6	(417.3 mil)	+0.20/-0.10 (+7.9/-3.9 mil)
B	Module PCB width [mm]	10.0	(393.7 mil)	+0.20/-0.10 (+7.9/-3.9 mil)
C	Module thickness [mm]	2.2	(86.6 mil)	+0.40/-0.20 (+15.8/-7.9 mil)
ccc	Seating plane coplanarity [mm]	0.10	(3.9 mil)	+0.02/-0.10 (+0.8/-3.9 mil)
D	Horizontal edge to lateral pin no 1 edge [mm]	0.45	(17.7 mil)	+0.10/-0.10 (+3.9/-3.9 mil)
E	Vertical and horizontal edge to lateral pin no 1 edge	0.30	(11.8 mil)	+0.10/-0.10 (+3.9/-3.9 mil)
F	Vertical pin no1 edge to lateral pin edge [mm]	2.35	(92.5 mil)	+0.05/-0.05 (+2.0/-2.0 mil)
G	Depanaling residual [mm]	0.10	(3.9 mil)	+0.25/-0.10 (+9.8/-3.9 mil)
H	Lateral and antenna row pin to pin pitch [mm]	1.0	(39.4 mil)	+0.05/-0.05 (+2.0/-2.0 mil)
I	Lateral and antenna row pin width [mm]	0.70	(27.6 mil)	+0.05/-0.05 (+2.0/-2.0 mil)
J	Lateral and antenna row pin height [mm]	1.15	(45.3 mil)	+0.05/-0.05 (+2.0/-2.0 mil)
K	Horizontal pin no1 edge to central pin edge [mm]	2.78	(109.4 mil)	+0.05/-0.05 (+2.0/-2.0 mil)
L	Vertical pin no1 edge to central pin edge [mm]	2.63	(103.5 mil)	+0.05/-0.05 (+2.0/-2.0 mil)
M	Horizontal pin no1 edge to inner row pin edge [mm]	1.45	(57.1 mil)	+0.05/-0.05 (+2.0/-2.0 mil)
N	Vertical pin no1 edge to inner row pin edge [mm]	1.6	(63.0 mil)	+0.05/-0.05 (+2.0/-2.0 mil)
O	Central pin and inner row width and height [mm]	0.70	(27.6 mil)	+0.05/-0.05 (+2.0/-2.0 mil)
P	Central pin to pin pitch [mm]	1.15	(45.3 mil)	+0.05/-0.05 (+2.0/-2.0 mil)
Q	Inner row pin to pin pitch [mm]	1.1	(43.3 mil)	+0.05/-0.05 (+2.0/-2.0 mil)
R	Horizontal pin no1 edge to antenna row pin edge [mm]	8.7	(342.5 mil)	+0.05/-0.05 (+2.0/-2.0 mil)
	Module weight [g]	<1.0		

Table 19: NINA-W151 mechanical outline data

5.2 NINA-W152 mechanical specification

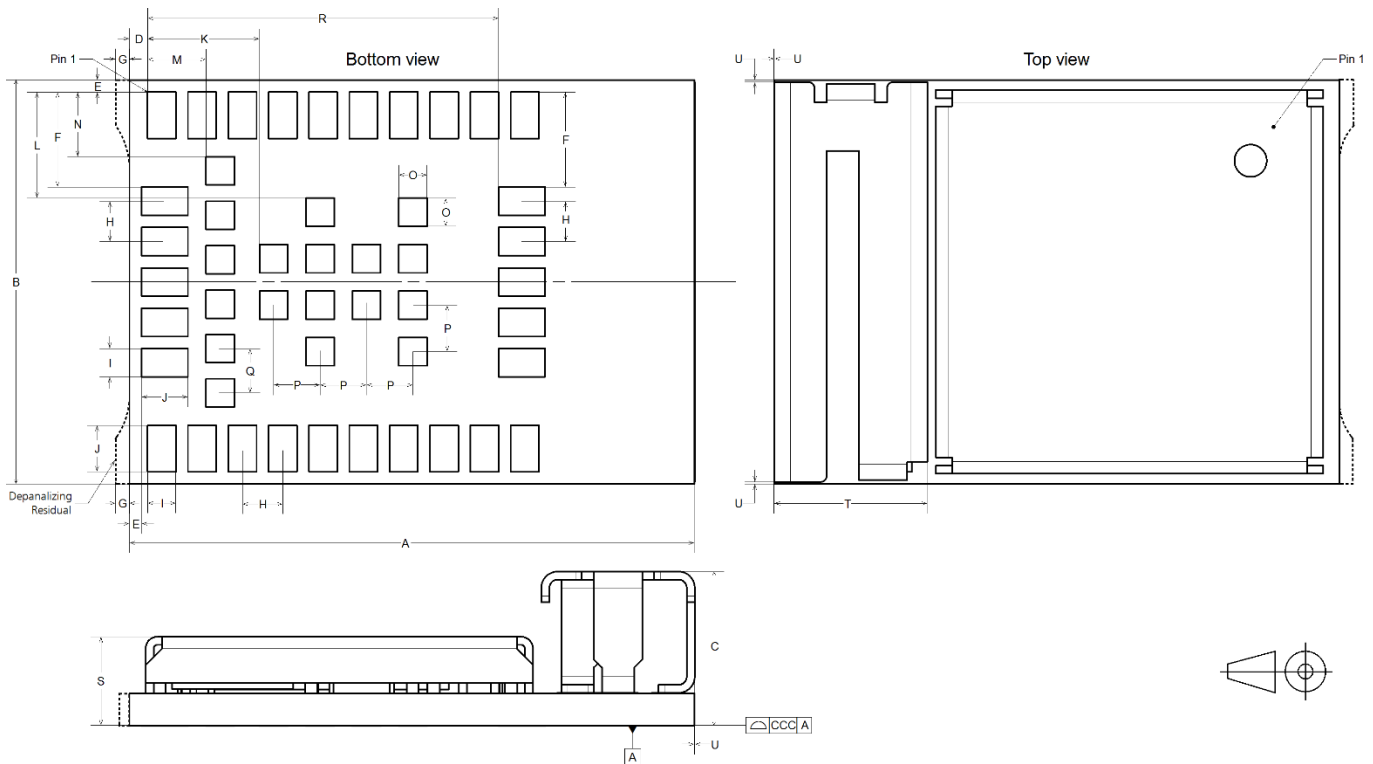

Figure 7: NINA-W152 mechanical outline

Parameter	Description	Typical	Tolerance
A	Module PCB length [mm]	14.0 (551.2 mil)	+0.20/-0.10 (+7.9/-3.9 mil)
B	Module PCB width [mm]	10.0 (393.7 mil)	+0.20/-0.10 (+7.9/-3.9 mil)
C	Module thickness [mm]	3.8 (149.6 mil)	+0.40/-0.20 (+15.8/-7.9)
ccc	Seating plane coplanarity [mm]	0.10 (3.9 mil)	+0.02/-0.10 (+0.8/-3.9 mil)
D	Horizontal edge to lateral pin no 1 edge [mm]	0.45 (17.7 mil)	+0.10/-0.10 (+3.9/-3.9 mil)
E	Vertical and horizontal edge to lateral pin no 1 edge	0.30 (11.8 mil)	+0.10/-0.10 (+3.9/-3.9 mil)
F	Vertical pin no1 edge to lateral pin edge [mm]	2.35 (92.5 mil)	+0.05/-0.05 (+2.0/-2.0 mil)
G	Depanaling residual [mm]	0.10 (3.9 mil)	+0.25/-0.10 (+9.8/-3.9 mil)
H	Lateral and antenna row pin to pin pitch [mm]	1.0 (39.4 mil)	+0.05/-0.05 (+2.0/-2.0 mil)
I	Lateral and antenna row pin width [mm]	0.70 (27.6 mil)	+0.05/-0.05 (+2.0/-2.0 mil)
J	Lateral and antenna row pin height [mm]	1.15 (45.3 mil)	+0.05/-0.05 (+2.0/-2.0 mil)
K	Horizontal pin no1 edge to central pin edge [mm]	2.78 (109.4 mil)	+0.05/-0.05 (+2.0/-2.0 mil)
L	Vertical pin no1 edge to central pin edge [mm]	2.63 (103.5 mil)	+0.05/-0.05 (+2.0/-2.0 mil)
M	Horizontal pin no1 edge to inner row pin edge [mm]	1.45 (57.1 mil)	+0.05/-0.05 (+2.0/-2.0 mil)
N	Vertical pin no1 edge to inner row pin edge [mm]	1.6 (63.0 mil)	+0.05/-0.05 (+2.0/-2.0 mil)
O	Central pin and inner row width and height [mm]	0.70 (27.6 mil)	+0.05/-0.05 (+2.0/-2.0 mil)
P	Central pin to central pin pitch [mm]	1.15 (45.3 mil)	+0.05/-0.05 (+2.0/-2.0 mil)
Q	Inner row pin to pin pitch [mm]	1.1 (43.3 mil)	+0.05/-0.05 (+2.0/-2.0 mil)
R	Horizontal pin no1 edge to antenna row pin edge [mm]	8.7 (342.5 mil)	+0.05/-0.05 (+2.0/-2.0 mil)
S	PCB and shield cover thickness [mm]	2.2 (86.6 mil)	+0.40/-0.20 (+15.8/-7.9)
T	Module antenna width [mm]	3.8 (149.6 mil)	+0.20/-0.20 (+7.9/-7.9 mil)
U	Antenna overhang outside module outline on any side	0.0 (0.0 mil)	+0.60 (+23.6 mil)
	module weight [g]	<1.0	

Table 20: NINA-W152 mechanical outline data

5.3 NINA-W156 mechanical specification

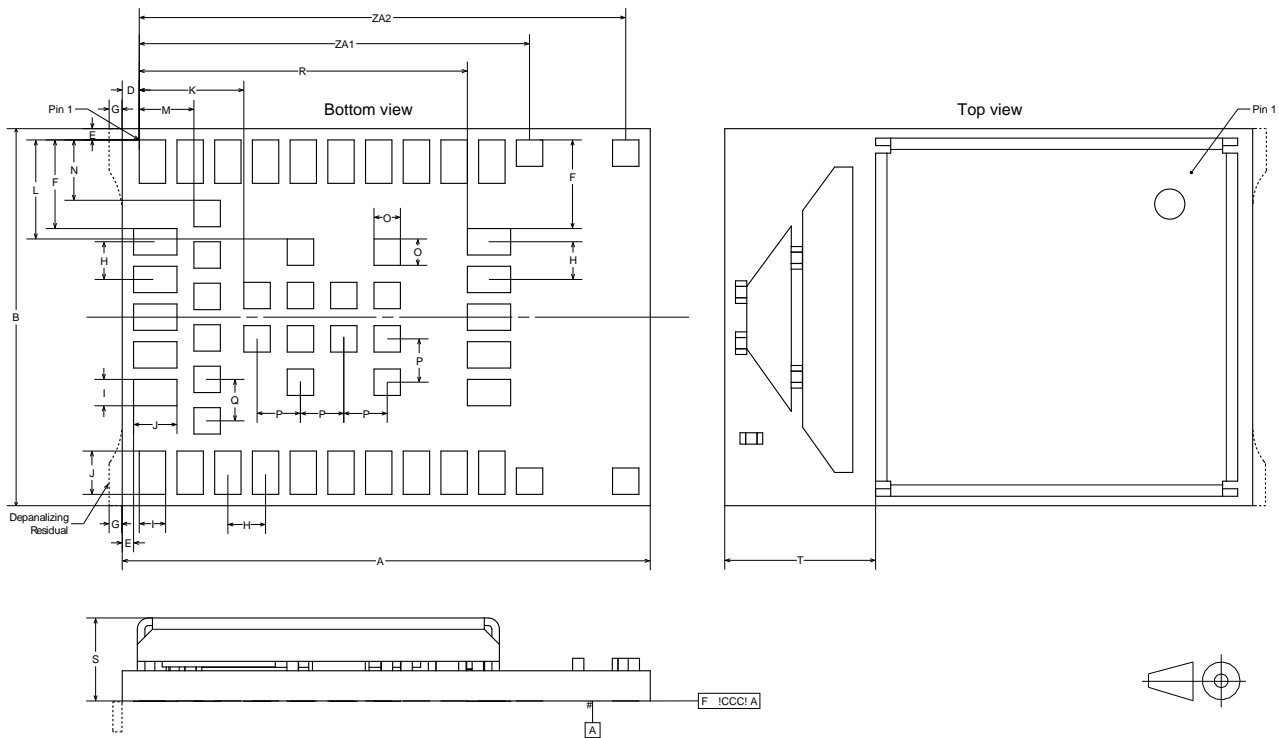

Figure 8: NINA-W156 mechanical outline

Parameter	Description	Typical	Tolerance
A	Module PCB length [mm]	14.0 (551.2 mil)	+0.20/-0.10 (+7.9/-3.9 mil)
B	Module PCB width [mm]	10.0 (393.7 mil)	+0.20/-0.10 (+7.9/-3.9 mil)
ccc	Seating plane coplanarity [mm]	0.10 (3.9 mil)	+0.02/-0.10 (+0.8/-3.9 mil)
D	Horizontal edge to lateral pin no 1 edge [mm]	0.45 (17.7 mil)	+0.10/-0.10 (+3.9/-3.9 mil)
E	Vertical and horizontal edge to lateral pin no 1 edge [mm]	0.30 (11.8 mil)	+0.10/-0.10 (+3.9/-3.9 mil)
F	Vertical pin no1 edge to lateral pin edge [mm]	2.35 (92.5 mil)	+0.05/-0.05 (+2.0/-2.0 mil)
G	Depanaling residual [mm]	0.10 (3.9 mil)	+0.25/-0.10 (+9.8/-3.9 mil)
H	Lateral and antenna row pin to pin pitch [mm]	1.0 (39.4 mil)	+0.05/-0.05 (+2.0/-2.0 mil)
I	Lateral and antenna row pin width [mm]	0.70 (27.6 mil)	+0.05/-0.05 (+2.0/-2.0 mil)
J	Lateral and antenna row pin height [mm]	1.15 (45.3 mil)	+0.05/-0.05 (+2.0/-2.0 mil)
K	Horizontal pin no1 edge to central pin edge [mm]	2.78 (109.4 mil)	+0.05/-0.05 (+2.0/-2.0 mil)
L	Vertical pin no1 edge to central pin edge [mm]	2.63 (103.5 mil)	+0.05/-0.05 (+2.0/-2.0 mil)
M	Horizontal pin no1 edge to inner row pin edge [mm]	1.45 (57.1 mil)	+0.05/-0.05 (+2.0/-2.0 mil)
N	Vertical pin no1 edge to inner row pin edge [mm]	1.6 (63.0 mil)	+0.05/-0.05 (+2.0/-2.0 mil)
O	Central pin and inner row width and height [mm]	0.70 (27.6 mil)	+0.05/-0.05 (+2.0/-2.0 mil)
P	Central pin to central pin pitch [mm]	1.15 (45.3 mil)	+0.05/-0.05 (+2.0/-2.0 mil)
Q	Inner row pin to pin pitch [mm]	1.1 (43.3 mil)	+0.05/-0.05 (+2.0/-2.0 mil)
R	Horizontal pin no1 edge to antenna row pin edge [mm]	8.7 (342.5 mil)	+0.05/-0.05 (+2.0/-2.0 mil)
S	PCB and shield cover thickness [mm]	2.2 (86.6 mil)	+0.40/-0.20 (+15.8/-7.9)
T	Module PCB antenna width [mm]	4.0 (157.5 mil)	+0.20/-0.20 (+7.9/-7.9 mil)
ZA1	Horizontal pin no. 1 corner to first set of antenna GND pins pin center [mm]	10.35 (407.8 mil)	+0.20/-0.10 (+7.9/-3.9 mil)
ZA2	Horizontal pin no. 1 corner to second set of antenna GND pins pin center [mm]	12.90 (507.9 mil)	+0.20/-0.10 (+7.9/-3.9 mil)
	Module weight [g]	<1.0	

Table 21: NINA-W156 mechanical outline data

6 Qualification and approvals

 Country approval for NINA-W156 is pending.

6.1 Country approvals

The NINA-W15 module series is certified for use in the following countries/regions:

- Europe (RED)
- USA (FCC)
- Canada (IC)
- Japan (MIC)
- Taiwan (NCC)
- South Korea (KCC)
- Brazil (ANATEL)
- Australia and New Zealand (ACMA)
- South Africa (ICASA)*

*Country approval for NINA-W156 is pending

6.2 European Union regulatory compliance

Information about regulatory compliance of the European Union for NINA-W15 series modules is available in the NINA-W15 Declaration of Conformity [5].

6.2.1 Radio Equipment Directive (RED) 2014/53/EU

NINA-W15 series modules comply with the essential requirements and other relevant provisions of Radio Equipment Directive (RED) 2014/53/EU.

6.2.2 Compliance with the RoHS directive

NINA-W15 series modules comply with the Directive 2011/65/EU (EU RoHS 2) and its amendment Directive (EU) 2015/863 (EU RoHS 3).

6.3 FCC/IC compliance

This device complies with Part 15 of the FCC Rules and with Industry Canada license-exempt RSS standard(s).

 Any changes or modifications NOT explicitly APPROVED by u-blox AG may cause the module to not comply with the FCC rules part 15 thus void the user's authority to operate the equipment.

6.3.1 FCC compliance

NINA-W15 modules are for OEM integrations only. The end-product will be professionally installed in such manner that only the authorized antennas can be used.

For NINA-W151, an external antenna connector (U.FL. connector) reference design (see the NINA-W1 series system integration manual [1]) is available and must be followed to comply with the NINA-W15 FCC/IC modular approval.

6.3.2 FCC statement

This device complies with Part 15 of the FCC Rules. Operation is subject to the following two conditions:

1. This device may not cause harmful interference, and
2. This device must accept any interference received, including interference that may cause undesired operation.

This equipment has been tested and found to comply with the limits for a Class B digital device, pursuant to Part 15 of the FCC Rules. These limits are designed to provide reasonable protection against harmful interference in a residential installation. This equipment generates, uses and can radiate radio frequency energy and, if not installed and used in accordance with the instructions, may cause harmful interference to radio communications. However, there is no guarantee that the interference will not occur in a particular installation. If this equipment does cause harmful interference to radio or television reception, which can be determined by turning the equipment off and on, the user is encouraged to try to correct the interference by one or more of the following measures:

- Reorient or relocate the receiving antenna
- Increase the separation between the equipment and receiver
- Connect the equipment into an outlet on a circuit different from that to which the receiver is connected.
- Consult the dealer or an experienced radio/TV technician for help.

6.3.3 RF exposure statement

6.3.3.1 IC compliance

This equipment complies with the requirements of IC RSS-102 issue 5 radiation exposure limits set forth for an uncontrolled environment.

To ensure that the output power remains below the SAR evaluation Exemption limits defined in RSS-102 issue 5, customer applications integrating NINA-W156 must include a separation distance of at least 40 mm between the user (or bystander) and the antenna (or radiating element). For applications integrating NINA-W151 and NINA-W152 the separation distance of 30 mm is needed.

6.3.3.2 FCC compliance

This device complies with the FCC radiation exposure limits set forth for an uncontrolled environment.

To ensure that the output power remains below the SAR evaluation Exemption limits defined in SAR test exclusion limits in KDB 447498 D01v06, customer applications integrating NINA-W156 must include a separation distance of at least 45 mm between the user (or bystander) and the antenna (or radiating element). For applications integrating NINA-W151 and NINA-W152 the separation distance of 25 mm is needed.

6.3.4 End-product user manual instructions

6.3.4.1 IC compliance

User manuals for license-exempt radio apparatus shall contain the following text, or an equivalent notice that shall be displayed in a conspicuous location, either in the user manual or on the device, or both:

This device complies with Industry Canada's license-exempt RSSs. Operation is subject to the following two conditions:

- (1) This device may not cause interference; and*

(2) This device must accept any interference, including interference that may cause undesired operation of the device.

Under Industry Canada regulations, this radio transmitter can only operate using an antenna of a type and maximum (or lesser) gain approved for the transmitter by Industry Canada. To reduce potential radio interference to other users, the antenna type and its gain should be chosen in such a way that the equivalent isotropically radiated power (e.i.r.p.) is not more than that is necessary for successful communication.

 Le manuel d'utilisation des appareils radio exempts de licence doit contenir l'énoncé qui suit, ou l'équivalent, à un endroit bien en vue dans le manuel d'utilisation ou sur l'appareil, ou encore aux deux endroits.

Le présent appareil est conforme aux CNR d'Industrie Canada applicables aux appareils radio exempts de licence. L'exploitation est autorisée aux deux conditions suivantes:

- (1) l'appareil ne doit pas produire de brouillage;
- (2) l'utilisateur de l'appareil doit accepter tout brouillage radioélectrique subi, même si le brouillage est susceptible d'en compromettre le fonctionnement.

Conformément aux réglementations d'Industry Canada, cet émetteur radio ne peut fonctionner qu'à l'aide d'une antenne dont le type et le gain maximal (ou minimal) ont été approuvés pour cet émetteur par Industry Canada. Pour réduire le risque d'interférences avec d'autres utilisateurs, il faut choisir le type d'antenne et son gain de telle sorte que la puissance isotrope rayonnée équivalente (p.i.r.e) ne soit pas supérieure à celle requise pour obtenir une communication satisfaisante.

6.3.5 End-product labeling requirements

6.3.5.1 IC compliance

The host product shall be properly labelled to identify the modules within the host product.

The Innovation, Science and Economic Development Canada certification label of a module shall be clearly visible at all times when installed in the host product; otherwise, the host product must be labelled to display the Innovation, Science and Economic Development Canada certification number for the module, preceded by the word "Contains" or similar wording expressing the same meaning, as shown in Figure 9.

Le produit hôte devra être correctement étiqueté, de façon à permettre l'identification des modules qui s'y trouvent.

L'étiquette d'homologation d'un module d'Innovation, Sciences et Développement économique Canada devra être posée sur le produit hôte à un endroit bien en vue, en tout temps. En l'absence d'étiquette, le produit hôte doit porter une étiquette sur laquelle figure le numéro d'homologation du module d'Innovation, Sciences et Développement économique Canada, précédé du mot « contient », ou d'une formulation similaire allant dans le même sens et qui va comme suit:

This device contains FCC ID: XPYNINAW15 IC: 8595A-NINAW15

Figure 9 Example of an end product label

 NINA-W156 has other IDs, as described in Table 21.

6.3.5.2 FCC compliance

For an end product that uses the NINA-W151, NINA-W152 or NINA-W156 modules, there must be a label containing, at least, the information shown in Figure 9:

The label must be affixed on an exterior surface of the end product such that it will be visible upon inspection in compliance with the modular approval guidelines developed by the FCC.

 In accordance with 47 CFR § 15.19, the end-product shall bear the following statement in a conspicuous location on the device:

"This device complies with Part 15 of the FCC Rules. Operation is subject to the following two conditions:

- (1) this device may not cause harmful interference, and
- (2) this device must accept any interference received, including interference that may cause undesired operation."

When the device is so small or for such use that it is not practicable to place the statement above on it, the information shall be placed in a prominent location in the instruction manual or pamphlet supplied to the user or, alternatively, shall be placed on the container in which the device is marketed.

In case, where the final product will be installed in locations where the end user is unable to see the FCC ID and/or this statement, the FCC ID and the statement shall also be included in the end product manual.

Model	FCC ID	IC Certification Number
NINA-W151	XPYNINAW15	8595A-NINAW15
NINA-W152	XPYNINAW15	8595A-NINAW15
NINA-W156	XPYNINAW106	8595A-NINAW106

Table 22: FCC and IC IDs for the NINA-W15 series modules

6.3.6 End product compliance

6.3.6.1 General requirements

- Any changes to hardware, hosts or co-location configuration may require new radiated emission and SAR evaluation and/or testing.
- The regulatory compliance of NINA-W151 and NINA-W152 does not exempt the end product from being evaluated against applicable regulatory demands; for example, FCC Part 15B criteria for unintentional radiators.
- Only authorized antenna(s) may be used.
- Any notification to the end user about how to install or remove the integrated radio module is NOT allowed.

6.3.6.2 Co-location (simultaneous transmission)

If the module is to be co-located with another transmitter, additional measurement for simultaneous transmission is required.

6.4 Japan radio equipment compliance

6.4.1 Compliance statement

NINA-W15 series modules comply with the Japanese Technical Regulation Conformity Certification of Specified Radio Equipment (ordinance of MPT N°. 37, 1981), Article 2, Paragraph 1:

- Item 19 "2.4 GHz band wide band low power data communication system".

6.4.2 End product labelling requirement

End products based on NINA-W15 series modules and targeted for distribution in Japan must be affixed with a label with the "Giteki" marking, as shown in Figure 10.. The marking must be visible for inspection.

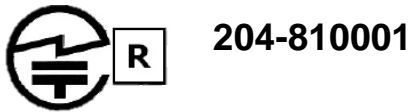

Figure 10: Giteki mark, **R** and the NINA-W151/NINA-W152 MIC certification number

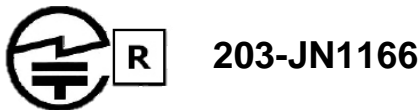

Figure 11: Giteki mark, **R** and the NINA-W156 MIC certification number

6.4.3 End product user manual requirement

As the MIC ID is not included on the NINA-W15 marking, the end product manufacturer must include a copy of the NINA-B4 Japan Radio Certificate in the end product technical documentation.

6.5 NCC Taiwan compliance

-  Approval for NINA-W156 is pending.

6.5.1 Taiwan NCC warning statement

- 經型式認證合格之低功率射頻電機，非經許可，公司、商號或使用者均不得擅自變更頻率、加大功率或變更原設計之特性及功能。
- 低功率射頻電機之使用不得影響飛航安全及干擾合法通信；經發現有干擾現象時，應立即停用，並改善至無干擾時方得繼續使用。前項合法通信，指依電信法規定作業之無線電通信。低功率射頻電機須忍受合法通信或工業、科學及醫療用電波輻射性電機設備之干擾。

Statement translation:

- Without permission granted by the NCC, any company, enterprise, or user is not allowed to change frequency, enhance transmitting power or alter original characteristic as well as performance to an approved low power radio frequency devices.
- The low power radio frequency devices shall not influence aircraft security and interfere legal communications; if found, the user shall cease operating immediately until no interference is achieved. The said legal communications means radio communications is operated in compliance with the Telecommunications Act. The low power radio frequency devices must be susceptible with the interference from legal communications or ISM radio wave radiated devices.

6.5.2 NINA-W151 labeling requirements for end product

When a product integrated with a NINA-W151 module is placed on the Taiwan market, the product must be affixed with a label marking as shown below. The label can use wording such as the following:

Contains Transmitter Module

內含發射器模組:  CCAJ18LP0B43T4

Any similar wording that expresses the same meaning may be used. The marking must be visible for inspection.

6.5.3 NINA-W152 labeling requirements for end product

When a product integrated with a NINA-W152 module is placed on the Taiwan market, the product must be affixed with a label marking as shown below. The label can use wording such as the following:

Contains Transmitter Module

內含發射器模組:  CCAJ18LP0B53T7

Any similar wording that expresses the same meaning may be used. The marking must be visible for inspection.

6.5.4 NINA-W156 labeling requirements for end product

When a product integrated with a NINA-W156 module is placed on the Taiwan market, the product must be affixed with a label marking as shown below. The label can use wording such as the following:

Contains Transmitter Module

內含發射器模組:  CCAI21Y1009AT3

Any similar wording that expresses the same meaning may be used. The marking must be visible for inspection.

6.6 KCC South Korea compliance

NINA-W15 series modules are certified by the Korea Communications Commission (KCC).

When a product containing a NINA-W15 module is placed on the South Korean market, the product must be affixed with a label or marking containing the KCC logo and certification number as shown in the figures below. This information must also be included in the product user manuals.

KCC certification number for NINA-W151 and NINA-W152:

 R-C-ULX-NINA-W151

KCC certification number for NINA-W156:

 R-C-ULX-NINA-W106

 The height of the KCC logo must be at least 5 mm.

6.7 Brazil compliance

When a product containing a NINA-W15 module is placed on the Brazilian market, the product must be affixed with a label or marking containing the Anatel logo, NINA-W151/ NINA-W152 Homologation number: 06870-18-05903 or NINA-W156: 05099-21-01056 and a statement claiming that the device may not cause harmful interference but must accept it (Resolution No 506).



Anatel logo and NINA-W151/
NINA-W152 Homologation number: 06870-18-05903



Anatel logo and NINA-W156 and Homologation number: NINA-W156: 05099-21-01056

“Este equipamento opera em caráter secundário, isto é, não tem direito a proteção contra interferência prejudicial, mesmo de estações do mesmo tipo, e não pode causar interferência a sistemas operando em caráter primário.”

Statement translation:

“This equipment operates on a secondary basis and, consequently, must accept harmful interference, including from stations of the same kind, and may not cause harmful interference to systems operating on a primary basis.”

When the device is so small or for such use that it is not practicable to place the statement above on it, the information shall be placed in a prominent location in the instruction manual or pamphlet supplied to the user or, alternatively, shall be placed on the container in which the device is marketed.

In cases, where the final product will be installed in locations where the end user is unable to see the Anatel logo, NINA-W15 Homologation number and/or this statement, the Anatel logo, NINA-W15 Homologation number, and the statement shall also be included in the end product manual.

6.8 Australia and New Zealand regulatory compliance



NINA-W151, NINA-W152 and NINA-W156 modules are compliant with the standards made by the Australian Communications and Media Authority (ACMA).

The modules are compliant with AS/NZS 4268:2012 standard – Radio equipment and systems – Short range devices – Limits and methods of standard measurement. The NINA-W151, NINA-W152 and NINA-W156 modules test reports can be used as part of the product certification and compliance folder. For more information on the test reports, [contact](#) your support team.

To meet overall Australian and/or New Zealand end product compliance, the integrator must create a compliance folder containing all the relevant compliance test reports such as RF, EMC, electrical safety and DoC (Declaration of Conformity) and so on. It is the responsibility of the integrator to know what is required in the compliance folder for ACMA compliance.

For more information on Australia compliance, refer to the Australian Communications and Media Authority web site <http://www.acma.gov.au/>.

For more information on New Zealand compliance, refer to the New Zealand Radio Spectrum Management Group web site www.rsm.govt.nz.

6.9 South Africa regulatory compliance

 Approval for NINA-W156 is pending.

NINA-W151 and NINA-W152 modules are compliant and certified by the Independent Communications Authority of South Africa (ICASA). End products that are made available for sale or lease or is supplied in any other manner in South Africa shall have a legible label permanently affixed to its exterior surface. The label shall have the ICASA logo and the ICASA issued license number as shown in the figure below. The minimum width and height of the ICASA logo shall be 3 mm. The approval labels must be purchased by the customer’s local representative directly from the approval authority ICASA. A sample of a NINA-W151/NINA-W152 ICASA label is included below:



More information on registration as a Responsible Integrator and labeling requirements can be found at the following website:

Independent Communications Authority of South Africa (ICASA) web site - <https://www.icasa.org.za>

6.10 Safety compliance

In order to fulfill the safety standard EN 60950-1, the NINA-W15 series modules must be supplied with a Class-2 Limited Power Source.

6.11 Bluetooth qualification information



[®] End products are required to be qualified and listed for the Bluetooth Special Interest Group (SIG).

Product declarations are submitted through the Bluetooth SIG Launch Studio website:

[Bluetooth Launch Studio website](#)

NINA-W151, NINA-W152 and NINA-W156 modules have been qualified as a Controller Subsystem according to the Bluetooth 4.2 specification.

To list your product that integrates NINA-W151 or NINA-W152 as an End product with no required testing, combine the pre-qualified Controller Subsystem (QD ID 107058) and the Host Subsystem (QD ID 110883) listed in the table below.

To list your product that integrates NINA-W156 as an End product with no required testing, combine the pre-qualified Controller Subsystem (QD ID 152314) and the Host Subsystem (QD ID 110883) listed in Table 23.

Model	Product type	QD ID	Listing date
NINA-W151, NINA-W152	Controller Subsystem	107058	14-Mar-2018
NINA-W156	Controller Subsystem	152314	17-Dec-2020
NINA-W151, NINA-W152, NINA-W156	Host Subsystem	110883	30-Apr-2018

Table 23: NINA-W151/NINA-W152/NINA-W156 Bluetooth QD ID

7 Antennas

This chapter gives an overview of the different external antennas that can be used together with the module.

- ⚠ This radio transmitter IC: 8595A-NINAW15 has been approved by Industry Canada to operate with the antenna types listed below with the maximum permissible gain and required antenna impedance for each antenna type indicated. Antenna types not included in this list, having a gain greater than the maximum gain indicated for that type, are strictly prohibited for use with this device.
- ⚠ Cet émetteur radio IC: 8595A-NINAW15 été approuvé par Industry Canada pour fonctionner avec les types d'antenne énumérés ci-dessous avec le gain maximum autorisé et l'impédance nécessaire pour chaque type d'antenne indiqué. Les types d'antenne ne figurant pas dans cette liste et ayant un gain supérieur au gain maximum indiqué pour ce type-là sont strictement interdits d'utilisation avec cet appareil.

For each antenna, the "Approvals" field defines in which test reports the antenna is included. Definitions of the «Approvals» field are:

- FCC - The antenna is included in the FCC test reports and thus approved for use in countries that accept the FCC radio approvals, primarily US.
- IC - The antenna is included in the IC (Industrie Canada) test reports and thus approved for use in countries that accept the IC radio approvals, primarily Canada.
- RED - The antenna is included in the ETSI test reports and thus approved for use in countries that accept the Radio Equipment Directive, primarily the European countries.
- MIC - The antenna is included in the Japanese government affiliated MIC test reports and thus approved for use in the Japanese market.
- NCC - The antenna is included in the Taiwan NCC test reports and thus approved for use in Taiwan.
- KCC - The antenna is included in the Korea KCC test reports and thus approved for use in Korea.
- ANATEL – The antenna is included in the Brazil Anatel test reports and thus approved for use in Brazil.
- ACMA – The antenna is included in the Australia and New Zealand test reports and thus approved for use in Australia and New Zealand.
- ICASA – The antenna is included in the South Africa ICASA test reports and thus approved for use in South Africa.

In general, antennas with SMD connection, Reverse Polarity SMA connector or U.FL connector are included in FCC, IC, RED, MIC, NCC, KCC, ANATEL, ACMA and ICASA radio tests. The antennas with SMA connector are included in RED, MIC, NCC, KCC, ANATEL, ACMA and ICASA radio tests but not in the FCC or IC due to FCC/IC regulations.

The external antennas are connected to the board through U.FL connectors. Some antennas are connected directly to the U.FL connector of the board while some are connected using an SMA or reversed polarity SMA connector through a short U.FL to SMA or reversed polarity SMA adapter cable.

7.1 Antenna accessories

Name	U.FL to SMA adapter cable
Connector	U.FL and SMA jack (outer thread and pin receptacle)
Impedance	50 Ω
Minimum cable loss	0.5 dB. The cable loss must be above the minimum cable loss to meet the regulatory requirements. Minimum cable length 100 mm.
Comment	The SMA connector can be mounted in a panel. For information about integration the U.FL connector, see also the NINA-W1 series system integration manual [1].
Approval	RED, MIC, NCC, KCC, ANATEL, ACMA and ICASA



Name	U.FL to Reverse Polarity SMA adapter cable
Connector	U.FL and Reverse Polarity SMA jack (outer thread and pin)
Impedance	50 Ω
Minimum cable loss	0.5 dB, The cable loss must be above the minimum cable loss to meet the regulatory requirements. Minimum cable length 100 mm.
Comment	The Reverse Polarity SMA connector can be mounted in a panel. For information about integration the U.FL connector, see also the NINA-W1 series system integration manual [1]. It is necessary to follow this reference design to comply with the NINA-W15 FCC/IC modular approvals.
Approval	FCC, IC, RED, MIC, NCC, KCC, ANATEL, ACMA and ICASA



7.2 Approved antennas

7.2.1 Single band antennas

NINA-W152	
Manufacturer	ProAnt
Gain	+3 dBi
Impedance	50 Ω
Size (HxWxL)	3.0 x 3.8 x 9.9 mm
Type	PIFA
Comment	SMD PIFA antenna on NINA-W152. The antenna should not be mounted inside a metal enclosure. See also Internal antenna .
Approval	FCC, IC, RED, MIC, NCC, KCC, ANATEL, ACMA, and ICASA



NINA-W156	
Manufacturer	ProAnt
Gain	+3 dBi
Impedance	N/A
Size (HxWxL)	1.1 x 3.4 x 10 mm
Type	PCB trace
Comment	PCB antenna on NINA-W156. The antenna should not be mounted inside a metal enclosure. See also Internal antenna .
Approval	FCC, IC, RED, MIC, NCC, KCC, ANATEL and ACMA



GW.26.0111

Manufacturer	Taoglas
Polarization	Vertical
Gain	+2.0 dBi
Impedance	50 Ω
Size	Ø 7.9 x 30.0 mm
Type	Monopole
Connector	SMA (M) .
Comment	To be mounted with a U.FL to SMA adapter cable.
Approval	RED, MIC, NCC, KCC, ANATEL, ACMA, and ICASA



ANT-2.4-CW-RH-RPS

Manufacturer	Linx
Polarization	Vertical
Gain	-1.0 dBi
Impedance	50 Ω
Size	Ø 7.4 x 27.0 mm
Type	Monopole
Connector	Reverse Polarity SMA plug (inner thread and pin receptacle).
Comment	To be mounted with a U.FL to SMA adapter cable. An SMA version antenna is also available but not recommended for use (ANT-2.4-CW-RH-SMA).
Approval	FCC, IC, RED, MIC, NCC, KCC, ANATEL, ACMA, and ICASA



Ex-It 2400 28 RP-SMA

Manufacturer	ProAnt
Polarization	Vertical
Gain	+3.0 dBi
Impedance	50 Ω
Size	Ø 12.0 x 28.0 mm
Type	Monopole
Connector	Reverse Polarity SMA plug (inner thread and pin receptacle).
Comment	The antenna adapter cable U.F.L part must be mounted on a metal ground plane for best performance. To be mounted with a U.FL to SMA adapter cable. An SMA version antenna is also available but not recommended for use (Ex-It 2400 28 SMA).
Approval	FCC, IC, RED, MIC, NCC, KCC, ANATEL, ACMA, and ICASA Original part number at certification: Ex-IT 2400 RP-SMA 28-001)



Ex-It 2400 28 U.FL-100

Manufacturer	ProAnt
Polarization	Vertical
Gain	+2.0 dBi
Impedance	50 Ω
Size	Ø 12.0 x 28.0 mm
Type	Monopole
Cable length	100 mm
Connector	U.FL. connector



Comment	<p>For best performance, the U.F.L part of the antenna adapter cable must be mounted on a metal ground plane. To be mounted with a U.FL connector.</p> <p>For information about integration the U.FL. connector, see also the NINA-W1 series system integration manual [1]. It is necessary to follow this reference design to comply with the NINA -W15 FCC/IC modular approvals.</p>
Approval	FCC, IC, RED, MIC, NCC, KCC, ANATEL, ACMA, and ICASA Original part number at certification: Ex-IT 2400 MHF 28)

Ex-It 2400 Foldable RP-SMA

Manufacturer	ProAnt
Polarization	Vertical
Gain	+3.0 dBi
Impedance	50 Ω
Size	Ø 10 x 83 mm
Type	Monopole
Connector	Reverse Polarity SMA plug (inner thread and pin receptacle)



Comment	To be mounted with a U.FL to SMA adapter cable. An SMA version antenna is also available but is not recommended for use (Ex-IT 2400 Foldable SMA).
Approval	FCC, IC, RED, MIC, NCC, KCC, ANATEL, ACMA, and ICASA Original part number at certification: Ex-IT 2400 RP-SMA 70-002)

Ex-It 2400 70

Manufacturer	ProAnt
Polarization	Vertical
Gain	+3.0 dBi
Impedance	50 Ω
Size	Ø 9.4 x 70.5 mm
Type	Monopole
Cable length	100 mm
Connector	U.FL. connector



Comment	<p>To be mounted with a U.FL connector.</p> <p>For information about integration the U.FL connector, see also the NINA-W1 series system integration manual [1]. It is necessary to follow this reference design to comply with the NINA-W1 FCC/IC modular approvals.</p>
Approval	FCC, IC, RED, MIC, NCC, KCC, ANATEL, ACMA, and ICASA Original part number at certification: Ex-IT 2400 MHF 70-001)

InSide™ 2400

Manufacturer	ProAnt
Gain	+3.0 dBi
Impedance	50 Ω
Size	27 x 12 mm (triangular)
Type	Patch
Cable length	100 mm
Connector	U.FL. connector
Comment	<p>Should be attached to a plastic enclosure or part for best performance.</p> <p>To be mounted with a U.FL connector.</p> <p>For information about integration the U.FL connector, see also the NINA-W1 series system integration manual [1]. It is necessary to follow this reference design to comply with the NINA-W15 FCC/IC modular approvals.</p>
Approval	FCC, IC, RED, MIC, NCC, KCC, ANATEL, ACMA, and ICASA



FlatWhip-2400

Manufacturer	ProAnt
Gain	+3.0 dBi
Impedance	50 Ω
Size	Ø 50.0 x 30.0 mm
Type	Monopole
Connector	SMA plug (inner thread and pin)
Comment	<p>To be mounted with a U.FL to SMA adapter cable.</p> <p>EOL. Use only for legacy products.</p>
Approval	RED, MIC, NCC, KCC, ANATEL, ACMA, and ICASA



Outside™-2400

Manufacturer	ProAnt
Gain	+3.0 dBi
Impedance	50 Ω
Size	36.0 x 18.0 x 16.0 mm
Type	Patch
Cable length	70 mm
Connector	U.FL. connector
Comment	<p>To be mounted with a U.FL connector.</p> <p>For information about integration the U.FL connector, see also the NINA-W1 series system integration manual [1]. It is necessary to follow this reference design to comply with the NINA-W15 FCC/IC modular approvals.</p>
Approval	FCC, IC, RED, MIC, NCC, KCC, ANATEL, ACMA, and ICASA



7.2.2 Dual-band antennas

InSide™ WLAN

Manufacturer	ProAnt
Gain	+3.0 dBi
Impedance	50 Ω
Size	27 x 12 mm (triangular)
Type	Patch
Cable length	100 mm
Connector	U.FL. connector
Comment	<p>Should be attached to a plastic enclosure or part for best performance. Dual-band (2.4 GHz / 5 GHz) antenna to be mounted with a U.FL connector.</p> <p>For information about integration the U.FL connector, see also the NINA-W1 series system integration manual [1]. It is necessary to follow this reference design to comply with the NINA-W15 FCC/IC modular approvals.</p>
Approval	FCC, IC, RED, MIC, NCC, KCC, ANATEL, ACMA, and ICASA



InSide™ WLAN Square

Manufacturer	ProAnt
Gain	+3.0 dBi
Impedance	50 Ω
Size	24x22x1 mm with mounting hole
Type	Patch
Cable length	100 mm
Connector	U.FL. connector
Comment	<p>Should be attached to a plastic enclosure or part for best performance. Dual-band (2.4 GHz / 5 GHz) antenna to be mounted with a U.FL connector.</p> <p>For information about integration the U.FL connector, see also the NINA-W1 series system integration manual [1]. It is necessary to follow this reference design to comply with the NINA-W15 FCC/IC modular approvals.</p>
Approval	FCC, IC, RED, MIC, NCC, KCC, ANATEL, ACMA, and ICASA

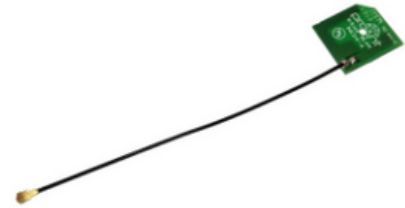

Ex-It WLAN Foldable RP-SMA

Manufacturer	ProAnt
Type	½ wave dipole dual-band antenna
Polarization	Vertical
Gain	+3 dBi
Impedance	50 Ω
Size	107 mm (Straight)
Type	Monopole
Connector	Reverse Polarity SMA plug (inner thread and pin receptacle)
Comment	To be mounted with a U.FL to SMA adapter cable.
Approval	FCC, IC, RED, MIC, NCC, KCC, ANATEL, ACMA, and ICASA Original part number at certification: Ex-IT WLAN RPSMA)



8 Product handling

8.1 Packaging

NINA-W15 modules are delivered as hermetically sealed, reeled tapes that enable efficient production, production lot set-up, and tear-down. For more information about packaging, see also the Packaging information reference [2].

! NINA-W15 series modules are in development status, as described in the [Document information](#). Consequently, the information in this section is valid and available only after the module is fully tested and approved during the Initial Production stage.

8.1.1 Reels

NINA-W15 modules are deliverable in quantities of 500 pieces on a reel. Table 24 describes the reel types for each module variant.

Model	Reel type
NINA-W151	B
NINA-W152	A
NINA-W156	A

Table 24: Reel types for NINA-W15 module variants

For further information about the reel types, see also the u-blox package information guide [2].

8.1.2 Tapes

Figure 12 shows the position and orientation of the NINA-W15 modules as they are delivered on tape.

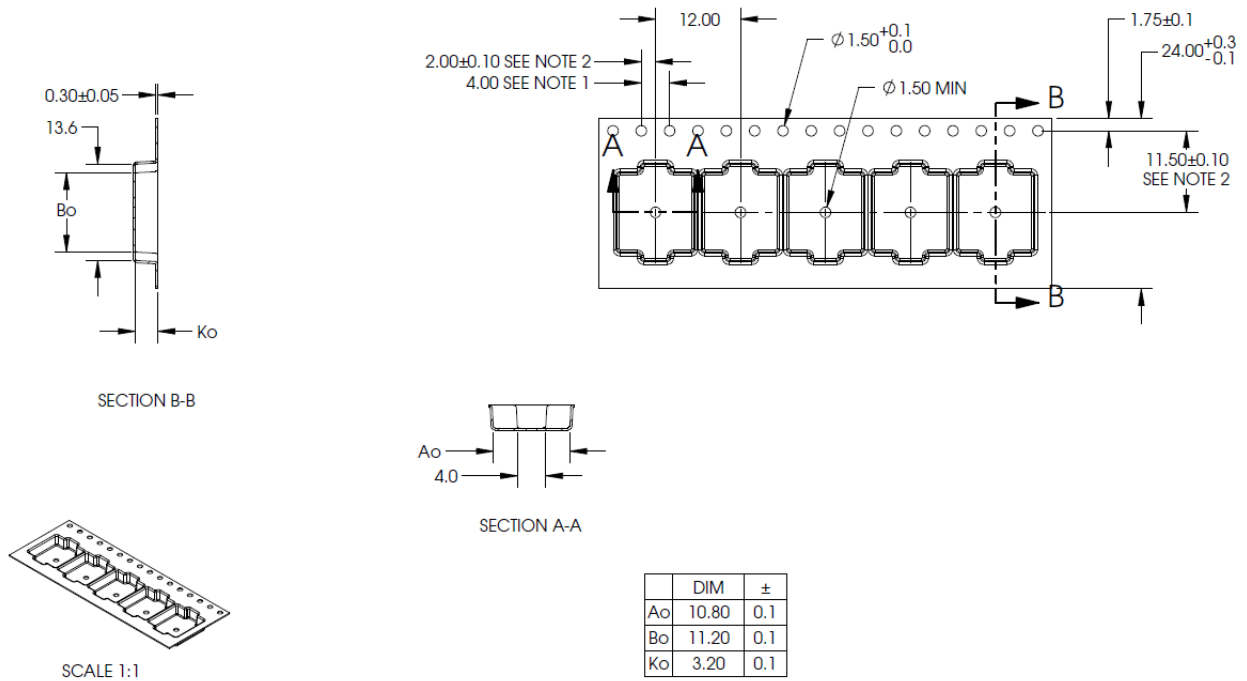

Figure 12: Orientation of NINA-W151 module on tape



Figure 13: Orientation of NINA-W152/NINA-W156 module on tape

The dimensions of the tapes for the various module variants are specified in Figure 14 and Figure 15.



- NOTES:
1. TO SPROCKET HOLE PITCH CUMULATIVE TOLERANCE ± 0.2
 2. POCKET POSITION RELATIVE TO SPROCKET HOLE MEASURED AS TRUE POSITION OF POCKET, NOT POCKET HOLE.
 3. Ao AND Bo ARE MEASURED ON A PLANE AT A DISTANCE "R" ABOVE THE BOTTOM OF THE POCKET.

Figure 14: NINA-W151 tape dimension

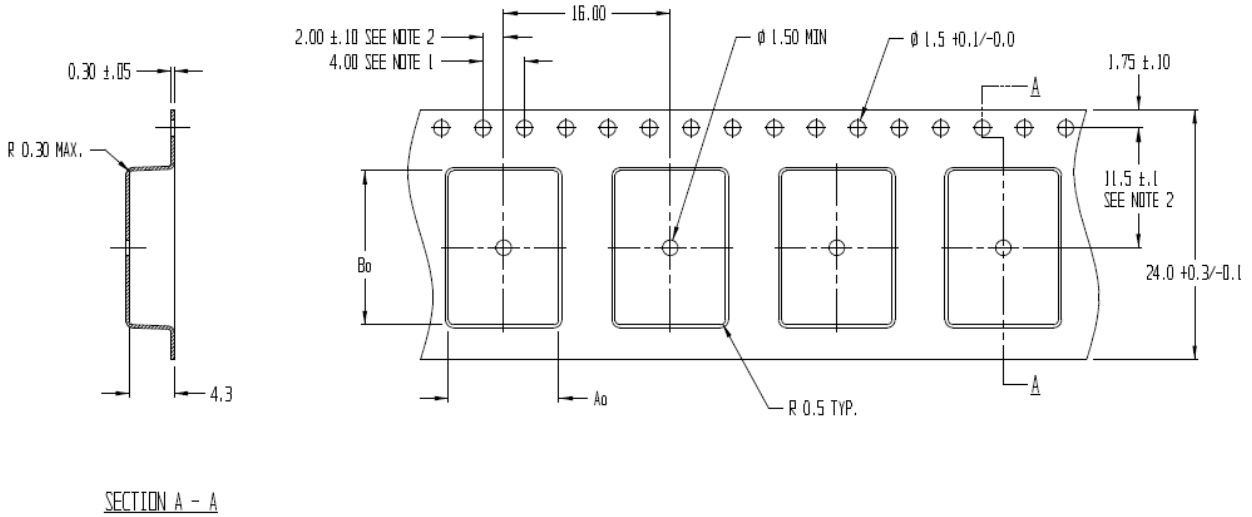

- NOTES:
1. TO SPROCKET HOLE PITCH CUMULATIVE TOLERANCE ± 0.2
 2. POCKET POSITION RELATIVE TO SPROCKET HOLE MEASURED AS TRUE POSITION OF POCKET, NOT POCKET HOLE
 3. Ao AND Bo ARE CALCULATED ON A PLANE AT A DISTANCE "R" ABOVE THE BOTTOM OF THE POCKET.

Figure 15: NINA-W152 tape dimension

8.2 Moisture sensitivity levels

-  NINA-W15 modules are rated as MSL Level 4 devices in accordance with the IPC/JEDEC J-STD-020 standard. For detailed information, see the moisture sensitive warning label on the MBB (Moisture Barrier Bag).

After opening the dry pack, the modules must be mounted within 168 hours in factory conditions of maximum 30 °C/60%RH or must be stored at less than 10%RH. The modules require baking if the humidity indicator card shows more than 10% when read at 23±5 °C or if the conditions mentioned above are not met. For information about the bake procedure, see also the J-STD-033B standard.

For more information regarding MSL (Moisture Sensitivity Level), labeling, and storage, see also the Packaging information guide [2].

8.3 Reflow soldering

NINA-W15 modules are approved for two-time reflow processes.

-  Reflow soldering profiles must be selected in accordance with u-blox soldering recommendations described in the NINA-W1 series system integration manual [1]. Failure to observe these recommendations can result in severe damage to the product.

8.4 ESD precautions

-  NINA-W15 series modules are Electrostatic Sensitive Devices that demand the observance of special handling precautions against static damage. Failure to observe these precautions can result in severe damage to the product. See also [Maximum ESD ratings](#).

Proper ESD handling and packaging procedures must be applied throughout the processing, handling, and operation of any application that incorporates the NINA-W15 series module. ESD precautions are particularly relevant when handling the application board on which the module is mounted.

For further information about the handling of NINA-W15 modules, see also the NINA-W15 series system integration manual.

9 Labeling and ordering information

9.1 Product labeling

The (7.5 x 7.5 mm) labels on NINA-W15 series modules include important product information.

Figure 16 shows the label applied to NINA-W15 series modules. Each of the given label references are described in Table 25.



Figure 16: Location of product type number on the NINA-W15 series module label

Reference	Description
1	Date of unit production encoded YY/WW (year, week)
2	Major and minor product version information
3	Product model name (NINA-W151, NINA-W152 or NINA-W156)
4	Data Matrix with unique serial number comprising 19 alphanumeric symbols: <ul style="list-style-type: none"> - The first 3 symbols are used for production tracking and are an abbreviated representation of the Type number that is unique to each module variant. - The following 12 symbols represent the unique hexadecimal Bluetooth address of the module AABCCDDEEFF, and - The last 4 symbols represent the hardware and firmware version encoded HHFF. See also MAC addresses .
5	u-blox logo with the red dot to indicate the position of pin 1.

Table 25: NINA-W15 series label description

9.2 Product identifiers

Table 27 describes the three product identifiers, namely the Type number, Model name and Ordering code.

Format	Description	Nomenclature
Model name	Describes the form factor, platform technology and platform variant. Used mostly in product documentation like this data sheet, the model name represents the most common identity for all u-blox products	PPPP-TGVV
Ordering code	Comprises the model name – with additional identifiers to describe the major product version and quality grade	PPPP-TGVV-TTQ
Type number	Comprises the model name and ordering code – with additional identifiers to describe minor product versions.	PPPP-TGVV-TTQ-XX

Table 26: Product code formats

9.3 Identification codes

Table 27 explains the parts of the product code.

Code	Meaning	Example
PPPP	Form factor	NINA
TG	Platform (Technology and Generation) T – Dominant technology, For example, W: Wi-Fi, B: Bluetooth G - Generation	W1: Wi-Fi Generation 1
VV	Variant based on the same platform; range [00...99]	51: u-connectXpress software product with antenna pin
TT	Major Product Version	00: first revision
Q	Quality grade A: Automotive B: Professional C: Standard	B: professional grade
XX	Minor product version (not relevant for certification)	Default value is 00

Table 27: Part identification code

9.4 Ordering information

Ordering Code	Product
NINA-W151-00B	Wi-Fi IEEE802.11b/g/n module with antenna pin. Includes u-connectXpress software with secure boot. Uses ESP32-D0WDQ6.
NINA-W151-02B	Wi-Fi IEEE802.11b/g/n module with antenna pin. Includes u-connectXpress software with secure boot. Uses ESP32-D0WDQ6-V3.
NINA-W151-03B	Wi-Fi IEEE802.11b/g/n module with antenna pin. Includes u-connectXpress software with secure boot. Uses ESP32-D0WDQ6-V3.
NINA-W152-00B	Wi-Fi IEEE802.11b/g/n module with internal PIFA antenna. Includes u-connectXpress software with secure boot. Uses ESP32-D0WDQ6.
NINA-W152-02B	Wi-Fi IEEE802.11b/g/n module with internal PIFA antenna. Includes u-connectXpress software with secure boot. Uses ESP32-D0WDQ6-V3.
NINA-W152-03B	Wi-Fi IEEE802.11b/g/n module with internal PIFA antenna. Includes u-connectXpress software with secure boot. Uses ESP32-D0WDQ6-V3
NINA-W156-03B	Wi-Fi IEEE802.11b/g/n module with internal PCB trace antenna. Includes u-connectXpress software with secure boot. Uses ESP32-D0WD-V3.

Table 28: Product ordering codes

Appendix

A Glossary

Abbreviation	Definition
ADC	Analog to Digital Converter
AFA	Automatic Frequency Adaptation
BLE	Bluetooth Low Energy
BPF	Band Pass Filter
CTS	Clear To Send
DAC	Digital to Analog Converter
DC	Direct Current
DSR	Data Set Ready
DTR	Data Terminal Ready
EOL	End Of Life
ESD	Electro Static Discharge
FCC	Federal Communications Commission
GND	Ground
GPIO	General Purpose Input/Output
I	Input (means that this is an input port of the module)
I2C	Inter-Integrated Circuit
IC	Industry Canada
IEEE	Institute of Electrical and Electronics Engineers
IoT	Internet of Things
L	Low
LPO	Low Power Oscillator
MCU	Micro Controller Unit
MDIO	Management Data Input / Output
MII	Media-Independent Interface
MISO	Master In Slave Out (data output from slave)
MOSI	Master Out Slave In (data output from master)
MRD	Market Requirement Document
MSD	Moisture Sensitive Device
N/A	Not Applicable
O	Output (means that this is an output port of the module)
PCN	Product Change Notification
PIFA	Planar Inverted F Antenna
PD	Pull-Down
PU	Pull-Up
QSPI	Quad Serial Peripheral Interface
RMII	Reduced Media Independent Interface
RTS	Request To Send
RXD	Receive Data
SDIO	Secure Digital Input Output
SDK	Software Development Kit
SPI	Serial Peripheral Interface

Abbreviation	Definition
TBD	To Be Defined
TXD	Transmit Data
UART	Universal Asynchronous Receiver/Transmitter
WKUP	Wake Up

Table 29: Explanation of the abbreviations and terms used

Related documents

- [1] NINA-W1 series system integration manual, [UBX-17005730](#)
- [2] Packaging information reference, [UBX-14001652](#)
- [3] u-connectXpress AT commands manual, [UBX-14044127](#)
- [4] NINA-W15 series product summary, [UBX-18052290](#)
- [5] NINA-W15 Declaration of Conformity, [UBX-19027744](#)
- [6] u-connectXpress software user guide, [UBX-16024251](#)
- [7] u-connectXpress SPI peripheral protocol specification, [UBX-20028725](#)

 For product change notifications and regular updates of u-blox documentation, register on our website, www.u-blox.com.

Revision history

Revision	Date	Name	Comments
R01	11-Dec-2018	mwej, kgom	Initial release.
R02	4-Jan-2019	mwej, kgom	Removed LPO functionality. Updated the information for pin 5 (Table 6). Modified the ordering code (Table 28).
R03	12-Jul-2019	mwej	<p>Modified the product status to Initial Production. Corrected information about restoring UART setting to default (section 2.6.3). Updated description of DSR signal usage in section 2.6.4. Updated voltage supply range (section 4.2.2) and Absolute maximum module supply voltage and maximum RF input ratings (section 4.1). Updated maximum ESD ratings (section 4.1.1). Updated current consumption (section 4.2.5). Updated Bluetooth output power and sensitivity (section 4.2.7 and 4.2.8).</p> <p>Included RoHS 3 compliance (section 6.2.2). Added certification information for Brazil, Australia, New Zealand, and South Africa (sections 6.7 to 6.9). Updated information about approved antennas (chapter 7).</p>
R04	14-Aug-2019	mwej	Corrected information about BLUE signal in connected mode (Table 5). Added information that the RED, GREEN and BLUE signals are disabled when using the RMII interface (sections 2.6.2 and 2.7.2).
R05	09-Jan-2020	miju, mwej,	Updated type numbers in the second table on page 2 with NINA-W15x-00B-01. Clarified that Wi-Fi and Bluetooth are time divided on the antenna and not active at the same time (section 2.5).
R06	17 Apr-2020	hekf	Added IEEE 802.11d and additional regulatory domains in chapter 1.7. Included product NINA-W156 and new variants of NINA-W151 and W152. Antenna radiation pattern is added in Chapter 4.2.9. Boot strap information is changed in chapter 2.4. Note that pins 25, 32 and 36 have ceased to be boot strap and GPIO pins. Pins 32 and 36 must be left unconnected. ESD ratings in chapter 4.1.1 is changed, GPIO drive capability current in chapter 4.2.4 is added. Access Point Mode added in chapter 1.6 Radio Performance. Changed the number of available GPIOs.
R07	29-Sep-2020	hekf, ajoh	Added footnote in ESD section 4.1.1. Added SPI support in sections 1.3, 2.4, 2.7, and 3.1. Changed the number of GPIOs for NINA-W156 product variant in section 3.1. Revised IEEE 802.11d statements. Updated module pinouts to include SPI and RMII. Added information on power modes, section 2.3. Added information on interface selection at module startup, section 2.7. Prepared for external LPO on NINA-W156 (section 2.2).
R08	18-Mar-2021	mape, hekf	Updated Bluetooth terminology. Removed Product features table in section 1, added two GPIOs for NINA-W156 in section 3. Updated Current consumption in Table 13, changed pull-up/pull-down resistance in section 4.2.4. Approved in EU/USA/Ca/Japan/Au/NZ. Bluetooth qualified. New RF Frequency Range in section 4.2.6. NINA-W156 changed status to Engineering Sample. Removed products NINA-W151-00B-00, NINA-W152-00B-00. Including RMII in the block diagram in section 1.3. A U.FL to SMA adapter cable now approved by NATEL, ACMA and ICASA in section 7.1. New GPIO clarifications in Table 6. Changed Table 12. Clarified pin 25, 27 and 36 may be configured to GPO. Adding product variants NINA-W151-03B and NINA-W132-03B in section 9.4.
R09	16-Apr-2021		Included minor changes to the document formatting and revised the FCC RF exposure statement.
R10	14-May-2021	hekf, fkru	Product status changed for NINA-W151-03B/W152-03B to Initial Production. u-connectXpress SW 4.0.0 introduced. Added certification information for NINA-W156 for South Korea and Japan.
R11	23-Jun-2021	hekf	Updated names for ProAnt Ex-It series antennas in section 7.2.
R12	20-Sep-2021	hekf	Declared the FlatWhip antenna as EOL and updated comments in the Approved antennas list . Updated NINA-W156-03B to Initial production and hardware revisions in Document information .

Revision	Date	Name	Comments
R13	09-Nov-2021	mhan, hekf, cche	Added information on how to disable channel 12 and 13 for Taiwan in the NINA-W15 IEEE 802.11d implementation description . Added new products NINA-W151/W152-03B-01 and removed NINA-W151/W152-00B-01, NINA-W151/W152-02B-00, and NINA-W151/W152-03B-00 in the Document information . Removed ambiguous description of operating condition ranges in Electrical specifications . Updated information describing Moisture sensitivity levels , Reflow soldering , and ESD precautions . Revised Maximum ESD ratings .

Contact

For complete contact information, visit us at www.u-blox.com.

u-blox Offices

North, Central and South America

u-blox America, Inc.

Phone: +1 703 483 3180
E-mail: info_us@u-blox.com

Regional Office West Coast:

Phone: +1 408 573 3640
E-mail: info_us@u-blox.com

Technical Support:

Phone: +1 703 483 3185
E-mail: support_us@u-blox.com

Headquarters

Europe, Middle East, Africa

u-blox AG

Phone: +41 44 722 74 44
E-mail: info@u-blox.com
Support: support@u-blox.com

Asia, Australia, Pacific

u-blox Singapore Pte. Ltd.

Phone: +65 6734 3811
E-mail: info_ap@u-blox.com
Support: support_ap@u-blox.com

Regional Office Australia:

Phone: +61 3 9566 7255
E-mail: info_au@u-blox.com
Support: support_ap@u-blox.com

Regional Office China (Beijing):

Phone: +86 10 68 133 545
E-mail: info_cn@u-blox.com
Support: support_cn@u-blox.com

Regional Office China (Chongqing):

Phone: +86 23 6815 1588
E-mail: info_cn@u-blox.com
Support: support_cn@u-blox.com

Regional Office China (Shanghai):

Phone: +86 21 6090 4832
E-mail: info_cn@u-blox.com
Support: support_cn@u-blox.com

Regional Office China (Shenzhen):

Phone: +86 755 8627 1083
E-mail: info_cn@u-blox.com
Support: support_cn@u-blox.com

Regional Office India:

Phone: +91 80 405 092 00
E-mail: info_in@u-blox.com
Support: support_in@u-blox.com

Regional Office Japan (Osaka):

Phone: +81 6 6941 3660
E-mail: info_jp@u-blox.com
Support: support_jp@u-blox.com

Regional Office Japan (Tokyo):

Phone: +81 3 5775 3850
E-mail: info_jp@u-blox.com
Support: support_jp@u-blox.com

Regional Office Korea:

Phone: +82 2 542 0861
E-mail: info_kr@u-blox.com
Support: support_kr@u-blox.com

Regional Office Taiwan:

Phone: +886 2 2657 1090
E-mail: info_tw@u-blox.com
Support: support_tw@u-blox.com