

**SOT-23 Plastic-Encap sulate Transistors**

**FEATURES**

- Complimentary to TKS8550
- Collector Current:  $I_C=0.5A$

**MARKING: J3Y**

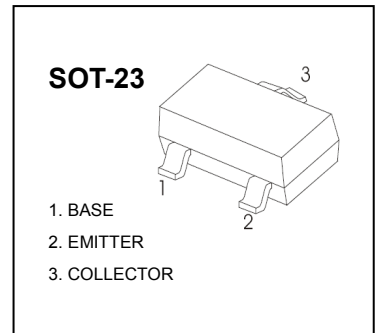

**MAXIMUM RATINGS ( $T_a=25^{\circ}C$  unless otherwise noted)**

Symbol	Parameter	Value	Unit
$V_{CBO}$	Collector-Base Voltage	40	V
$V_{CEO}$	Collector-Emitter Voltage	25	V
$V$	Emitter-Base Voltage	5	V
$I_C$	Collector Current	500	mA
$P_C$	Collector Power Dissipation	300	mW
$R_{\theta JA}$	Thermal Resistance From Junction To Ambient	417	$^{\circ}C/W$
$T_j$	Junction Temperature	150	$^{\circ}C$
$T_{stg}$	Storage Temperature	-55~+150	$^{\circ}C$

**ELECTRICAL CHARACTERISTICS ( $T_a=25^{\circ}C$  unless otherwise specified)**

Parameter	Symbol	Test conditions	Min	Typ	Max	Unit
Collector-base breakdown voltage	$V_{(BR)CBO}$	$I_C=100\mu A, I_E=0$	40			V
Collector-emitter breakdown voltage	$V_{(BR)CEO}$	$I_C=1mA, I_B=0$	25			V
Emitter-base breakdown voltage	$V_{(BR)EBO}$	$I_E=100\mu A, I_C=0$	5			V
Collector cut-off current	$I_{CBO}$	$V_{CB}=40V, I_E=0$			0.1	$\mu A$
Collector cut-off current	$I_{CEO}$	$V_{CB}=20V, I_E=0$			0.1	$\mu A$
Emitter cut-off current	$I_{EBO}$	$V_{EB}=5V, I_C=0$			0.1	$\mu A$
DC current gain	$h_{FE(1)}$	$V_{CE}=1V, I_C=50mA$	200		350	
	$h_{FE(2)}$	$V_{CE}=1V, I_C=500mA$	50			
Collector-emitter saturation voltage	$V_{CE(sat)}$	$I_C=500mA, I_B=50mA$			0.6	V
Base-emitter saturation voltage	$V_{BE(sat)}$	$I_C=500mA, I_B=50mA$			1.2	V
Transition frequency	$f_T$	$V_{CE}=6V, I_C=20mA$ $f=30MHz$	150			MHz

**CLASSIFICATION OF  $h_{FE(1)}$**

Range	200-350
MARKING	<b>J3Y</b>

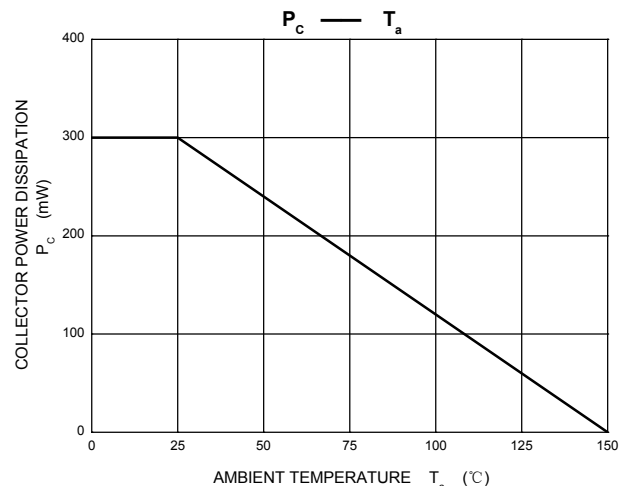
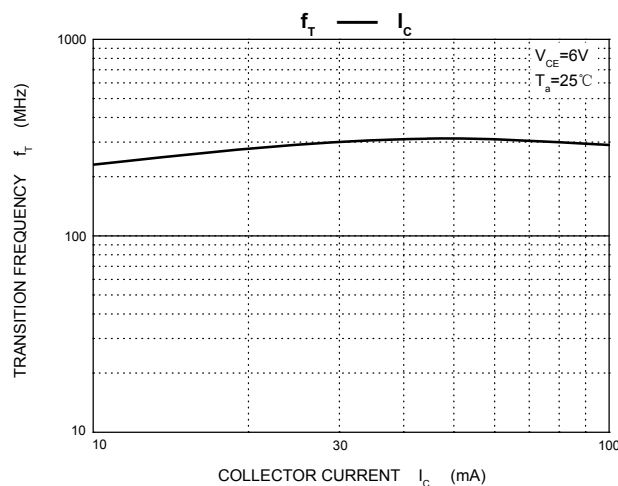
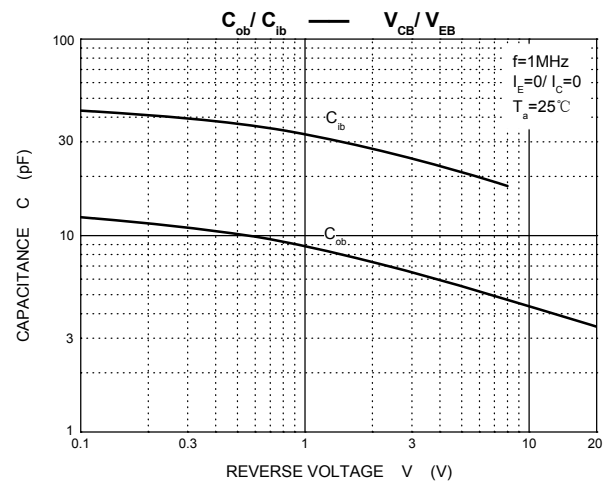
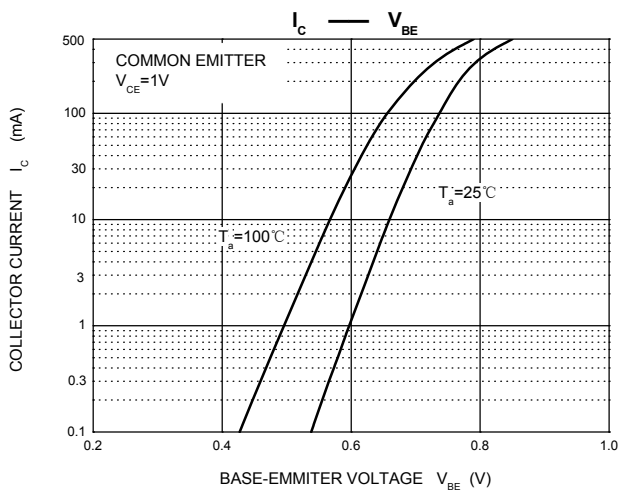
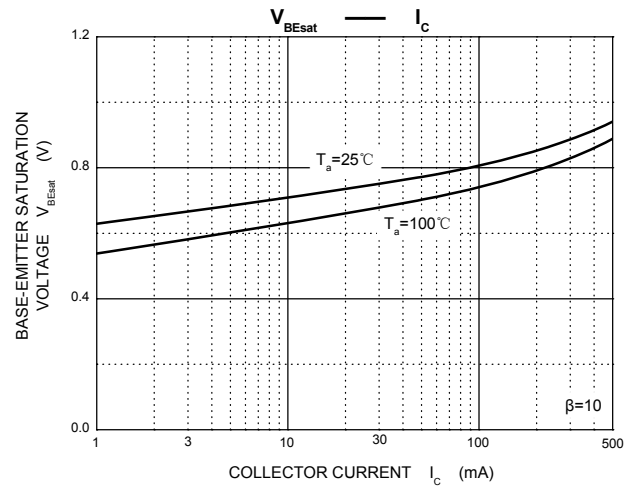
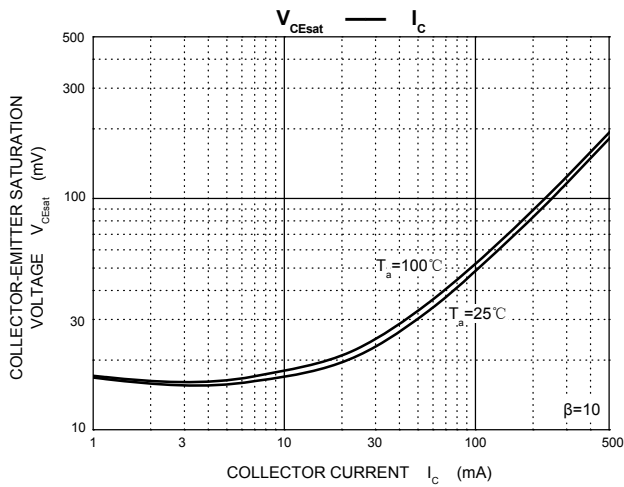
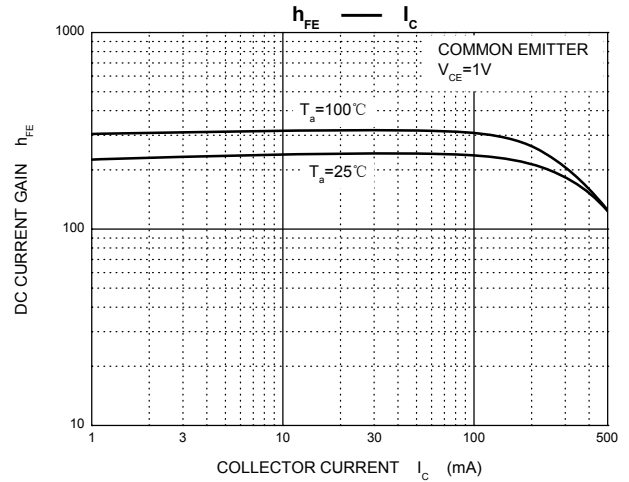
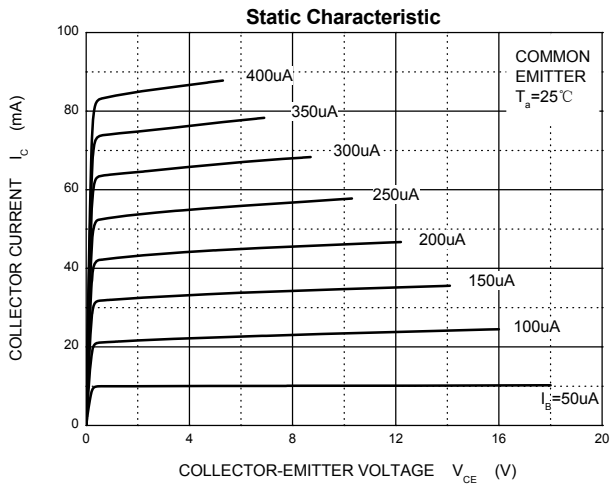

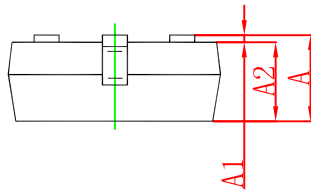
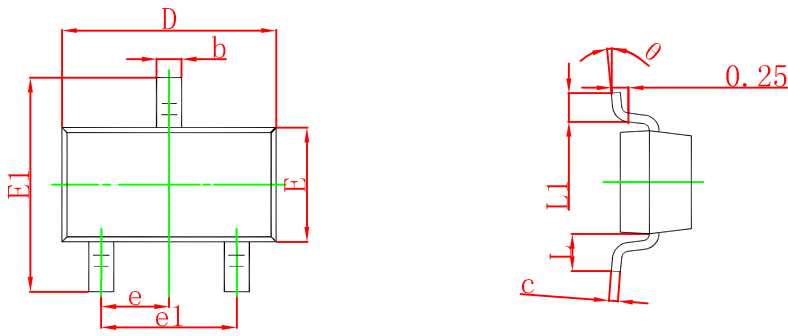

Symbol	Dimensions In Millimeters		Dimensions In Inches	
	Min	Max	Min	Max
A	0.900	1.150	0.035	0.045
A1	0.000	0.100	0.000	0.004
A2	0.900	1.050	0.035	0.041
b	0.300	0.500	0.012	0.020
c	0.080	0.150	0.003	0.006
D	2.800	3.000	0.110	0.118
E	1.200	1.400	0.047	0.055
E1	2.250	2.550	0.089	0.100
e	0.950 TYP		0.037 TYP	
e1	1.800	2.000	0.071	0.079
L	0.550 REF		0.022 REF	
L1	0.300	0.500	0.012	0.020
θ	0°	8°	0°	8°

## SOT-23 Suggested Pad Layout

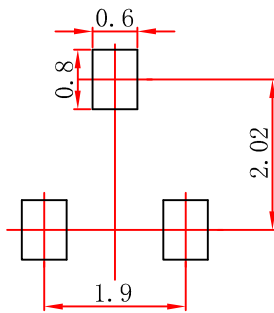

- Note:
1. Controlling dimension: in millimeters.
  2. General tolerance:  $\pm 0.05\text{mm}$ .
  3. The pad layout is for reference purposes only.