

RoHS
IP66~68

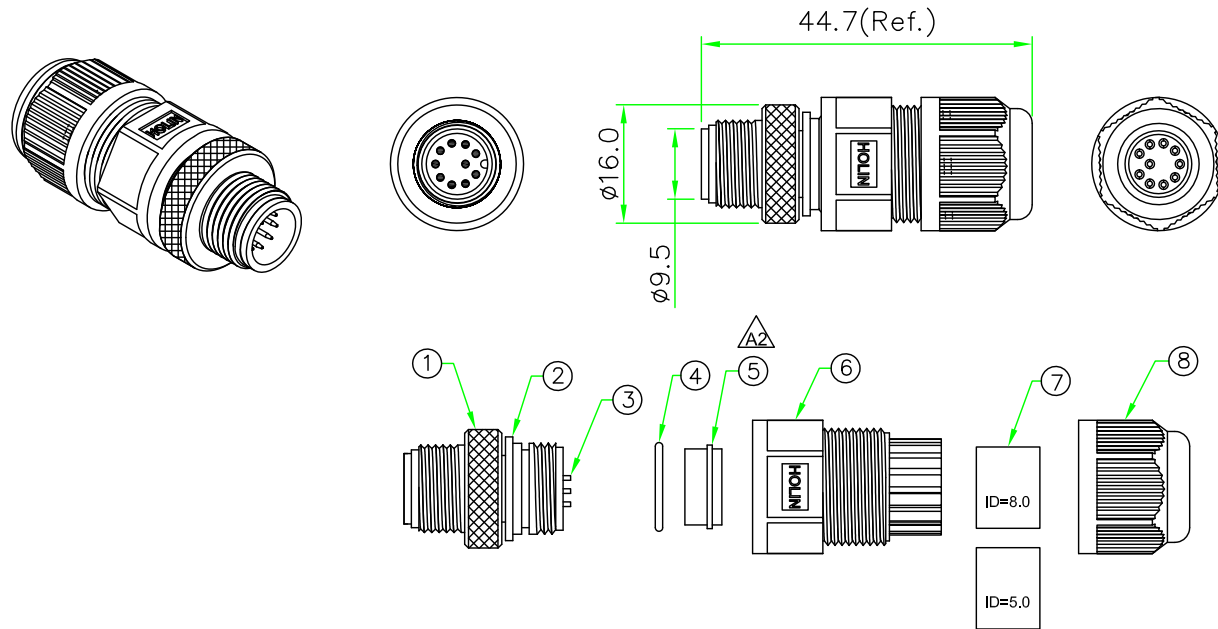

△A1 △A2 △A3

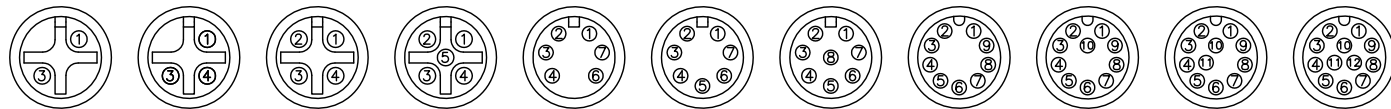

A12D-M102SA A12D-M103SA A12D-M104SA A12D-M105SA A12N-M106SA A12N-M107SA A12N-M108SA A12I-M109SA A12I-M110SA A12I-M111SA A12I-M112SA

PIN ASSIGNMENT FRONT VIEW
(前視圖)

REV.	DESCRIPTION	DATE
A	ISSUE	Jul/17/2008
A1	Increase A12D-M102SA	Nov/15/2011
A2	Change△Shape & Add 6.7 PIN Assignment	Sep/17/2014
A3	Add 9~12 PIN	Sep/09/2015

NOTES:

1. ELECTRICAL CHARACTERISTICS:

CURRENT RATING: 1.5A / 2A / 4A
CONNECTOR TEMPERATURE RANGE: -20°C TO +80°C
DIELECTRIC WITHSTANDING VOLTAGE:
500V AC FOR ONE MINUTE

2. HOW TO ORDER: A12x-M1xxSA

- 02 - 2 PIN 08 - 8 PIN
- 03 - 3 PIN 09 - 9 PIN
- 04 - 4 PIN 10 - 10 PIN
- 05 - 5 PIN 11 - 11 PIN
- 06 - 6 PIN 12 - 12 PIN
- 07 - 7 PIN

D - CURRENT RATING 4A
N - CURRENT RATING 2A
I - CURRENT RATING 1.5A

#2 Zipper PE Bag.

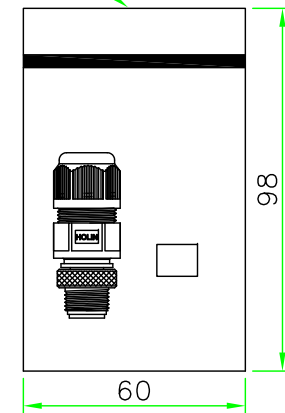

8	CLAMP NUT	NYLON+GF.	BLACK	1	
7	TUBE	RUBBER (ID=5.0 & 8.0mm)	BLACK	2	
6	HOOD	NYLON.	BLACK	1	
5	GASKET	EPDM.	BLACK	1	
4	O-RING	VITON.	BLACK	1	
3	CONTACT	BRASS, Male Pin. 6u" Gold Plated.		N	
2	CONNECTOR	M12 A-Coding Male Connector Insert. NYLON+GF.	BLACK	1	
1	SCREW NUT	BRASS, Nickel Plated.		1	
No.	PART NAME	DESCRIPTION	COLOR	Q'TY	REMARKS

HOLIN® HTP ASIA TECHNOLOGY CO., LTD.
禾凌科技股份有限公司

	UNIT: mm	TITLE :	M12 A-Coding Male Connector Male Pin Field Installable Plug
SCALE	1:1	P/N:	A12x-M1xxSA
UNLESS OTHERWISE SPECIFIED TOLERANCES:	.X ± 0.5 .XX ± 0.25 .XXX ± 0.1 ANGLE ± 1'	DR.	Patty
REV.	SHEET	CH.	ERIC
A3	1/1	DWG.NO:	A12x-M1xxSA
		AP.	

RoHS
IP66~68

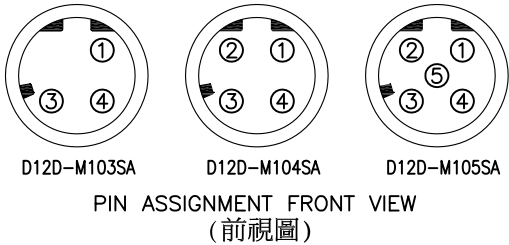
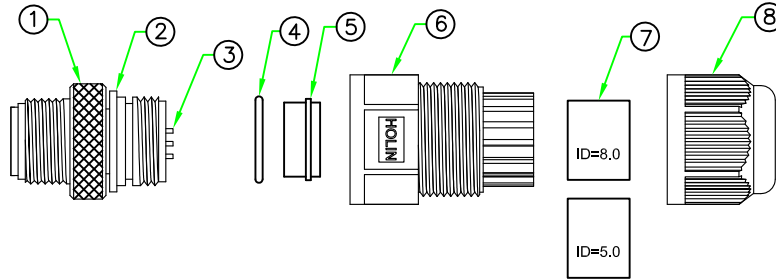
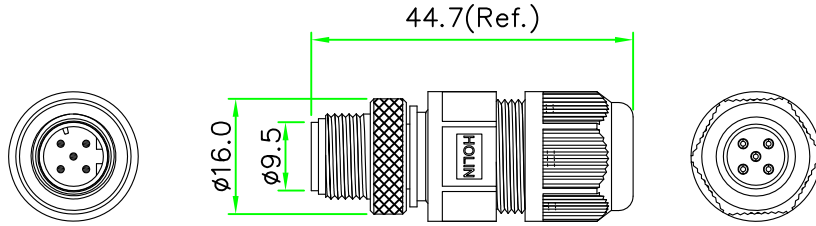
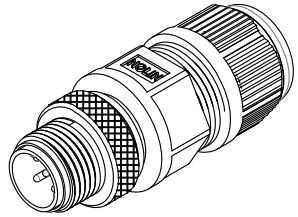

REV.	DESCRIPTION	DATE
A	ISSUE	Oct/16/2015

NOTES:

- ELECTRICAL CHARACTERISTICS:
CURRENT RATING: 4A
CONNECTOR TEMPERATURE RANGE: -20°C TO +80°C
DIELECTRIC WITHSTANDING VOLTAGE:
500V AC FOR ONE MINUTE
- HOW TO ORDER: D12D-M1xxSA

- 03 - 3 PIN
- 04 - 4 PIN
- 05 - 5 PIN

#2 Zipper PE Bag.

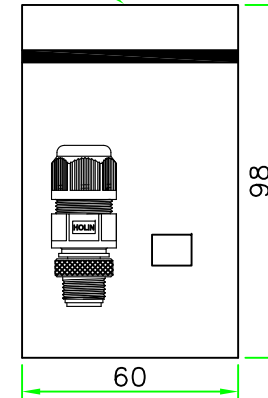

No.	PART NAME	DESCRIPTION	COLOR	Q'TY	REMARKS
8	CLAMP NUT	NYLON+GF.	BLACK	1	
7	TUBE	RUBBER (ID=5.0 & 8.0mm)	BLACK	2	
6	HOOD	NYLON.	BLACK	1	
5	GASKET	EPDM.	BLACK	1	
4	O-RING	VITON.	BLACK	1	
3	CONTACT	BRASS, Male Pin. 6u" Gold Plated.		N	
2	CONNECTOR	M12 D-Coding Male Connector Insert. NYLON+GF.	BLACK	1	
1	SCREW NUT	BRASS, Nickel Plated.		1	

HOLIN® HTP ASIA TECHNOLOGY CO., LTD.
禾凌科技股份有限公司

	UNIT: mm	TITLE :	M12 D-Coding
SCALE	1:1		Male Connector Male Pin
			Field Installable Plug
UNLESS OTHERWISE SPECIFIED TOLERANCES:		P/N:	D12D-M1xxSA
.x ± 0.5	.xx ± 0.25		
.xxx ± 0.1	ANGLE ± 1'		
REV.	SHEET	DWG.NO:	D12D-M1xxSA
A	1/1		

DR. Patty
CH. ERIC
AP.

RoHS
IP66~68

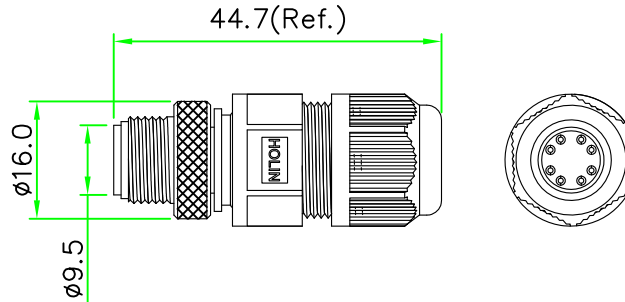
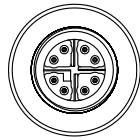
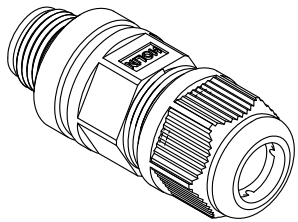
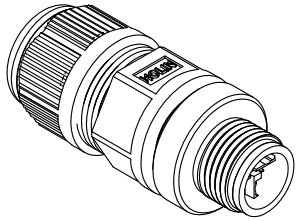

REV.	DESCRIPTION	DATE
A	ISSUE	Nov/12/2014

NOTES:

- ELECTRICAL CHARACTERISTICS:**
CURRENT RATING: 0.5A
CONNECTOR TEMPERATURE RANGE: -40°C TO +80°C
DIELECTRIC WITHSTANDING VOLTAGE:
500V AC FOR ONE MINUTE

#2 Zipper PE Bag.

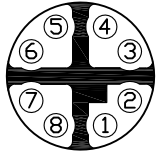
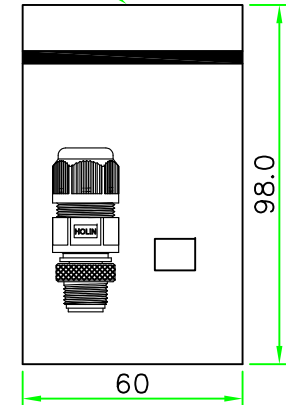

Pin Assignment
Front View
(前視圖)

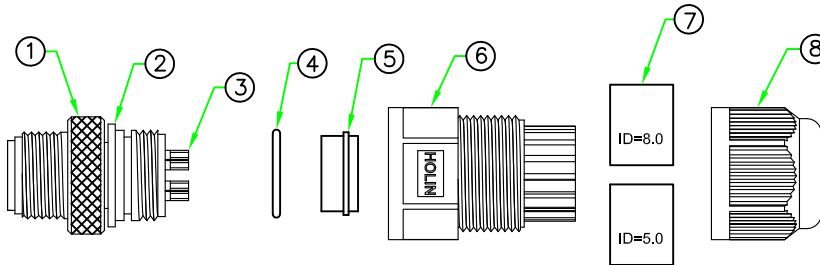

8	CLAMP NUT	NYLON+GF.	BLACK	1	
7	TUBE	RUBBER (ID=5.0 & 8.0mm)	BLACK	2	
6	HOOD	NYLON.	BLACK	1	
5	GASKET	EPDM.	BLACK	1	
4	O-RING	NBR.	BLACK	1	
3	CONTACT	BRASS , Male Pin. 6u" Gold Plated.		8	
2	CONNECTOR	M12 X-Coding Male Connector Insert. NYLON+GF.	BLACK	1	
1	SCREW NUT	BRASS , Nickel Plated.		1	
No.	PART NAME	DESCRIPTION	COLOR	Q'TY	REMARKS

HOLIN® HTP ASIA TECHNOLOGY CO., LTD.
禾凌科技股份有限公司

	UNIT: mm	TITLE : M12 X-Coding Male Connector Male Pin Field Installable Plug	
SCALE	1:1	P/N: X12I-M108SA	DR. Patty
UNLESS OTHERWISE SPECIFIED TOLERANCES: .x ± 0.25 .xx ± 0.1 .xxx ± 0.05 ANGLE ± 1°			CH. ERIC
REV. A	SHEET 1/1	DWG.NO: X12I-M108SA	AP.