

Isolation Amplifier with Video Driver

FEATURES

- Operating Voltage 4.5 to 5.5V
- Operating Temperature -40 to 105°C
- Common Mode Rejection Ratio -55dBtyp.
- 75Ω Driver
- DC Coupling, AC Coupling
- Voltage Gain 0dBtyp.
- Frequency Characteristics 0dB at 10MHz
- Bipolar Technology
- Package Outline SOT-23-5

GENERAL DESCRIPTION

NJM41005 is the isolation amplifier that has been developed in the video signal applications. It can remove the common-mode noise of the signal by the isolation amplifier. In addition, it has a built-in 75Ω driver, well suited to the interface of CAR AV.

APPLICATION

- Car Navigation
- Vehicle Camera ECU

APPLICATION CIRCUIT (DC Coupling)

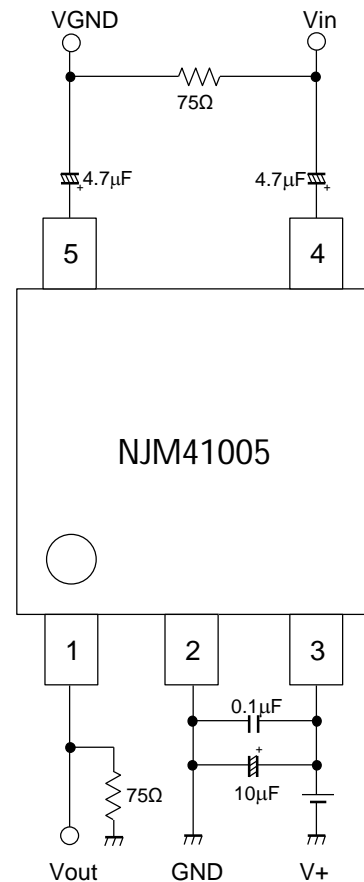

EQUIVALENT CIRCUIT · BLOCK DIAGRAM

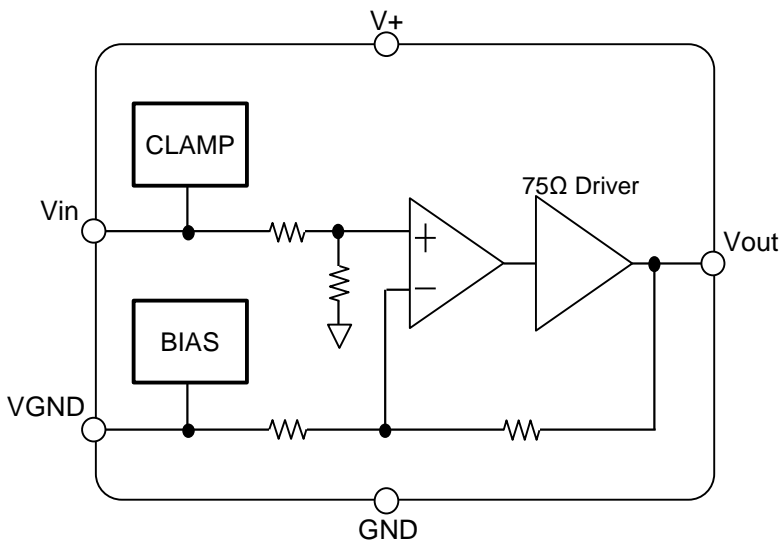

■ Isolation amplifier series

Channel	Part No.
1ch	NJM2505A
3ch	NJM41033

■ PIN CONFIGURATION

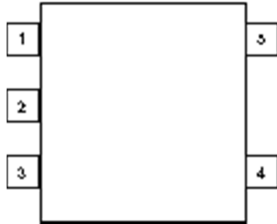

PIN NO.	SYMBOL	DESCRIPTION
1	Vout	Video Signal Output Terminal
2	GND	GND Terminal
3	V+	Power Supply Terminal
4	Vin	Video Signal Input Terminal
5	VGND	GND Input Terminal (from source side)

■ MARK INFORMATION

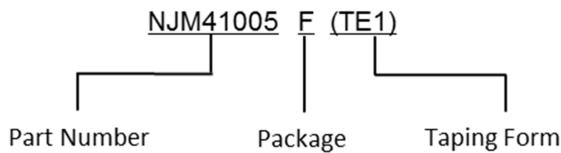

■ ORDERING INFORMATION

PART NUMBER	PACKAGE OUTLINE	RoHS	HALOGEN-FREE	TERMINAL FINISH	MARKING	WEIGHT (mg)	MOQ(pcs)
NJM41005F-T	SOT-23-5	YES	YES	Sn-Bi	AK2	15.0	3,000

■ABSOLUTE MAXIMUM RATINGS

PARAMETER	SYMBOL	RATINGS	UNIT
Supply Voltage	V+	7	V
Power Dissipation (Ta=25°C) ⁽⁴⁾	P _D	480 *1	mW
Operating Temperature Range	T _{opr}	-40 to 105	°C
Storage Temperature Range	T _{stg}	-40 to 150	°C

1) At on a board of EIA/JEDEC specification. (114.3 x 76.2 x 1.6mm 2 layers, FR-4)

■RECOMMENDED OPERATING CONDITIONS

PARAMETER	SYMBOL	RATINGS	UNIT
Supply Voltage	V+	4.5 to 5.5	V

■POWER DISSIPATION vs. AMBIENT TEMPERATURE

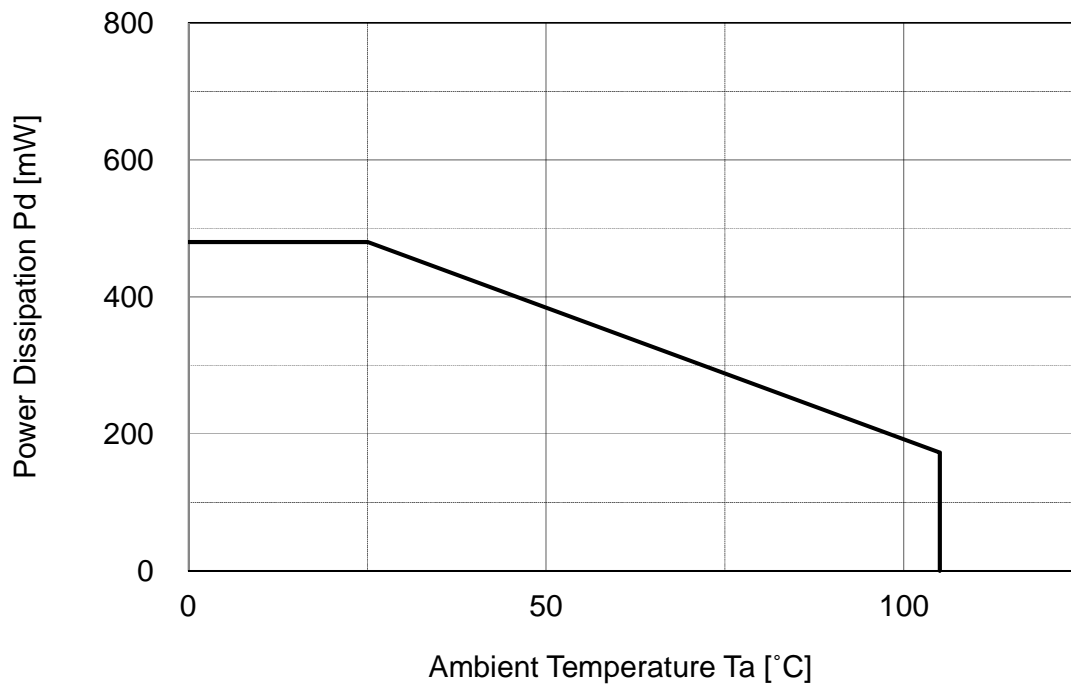

■ **ELECTRICAL CHARACTERISTICS** ($T_a=25^{\circ}\text{C}$, $V^+=5.0\text{V}$, $R_L=75\Omega$, unless otherwise specified)

PARAMETER	SYMBOL	TEST CONDITION	MIN.	TYP.	MAX.	UNIT
Operating Current	I_{cc}	No Signal, $R_L=OPEN$	-	10.0	14.0	mA
		No Signal, $R_L=OPEN$, $T_a=-40$ to 105°C	-	-	14.0	
Maximum Output Voltage Swing	V_{om}	$f=100\text{kHz}$, Input Sine Signal, THD=1%	2.2	2.4	-	Vp-p
		$f=100\text{kHz}$, Input Sine Signal, THD=1%, $T_a=-40$ to 105°C	2.2	-	-	
Voltage Gain	G_v	$V_{in}=100\text{kHz}$, 1.0Vp-p , Input Sine Signal	-0.5	0	0.5	dB
		$V_{in}=100\text{kHz}$, 1.0Vp-p , Input Sine Signal, $T_a=-40$ to 105°C	-0.5	-	0.5	
Frequency Characteristic	G_{f10M}	$V_{in}=10\text{MHz}/1\text{MHz}$, 1.0Vp-p , Input Sine Signal	-	0	-	dB
Common Mode Rejection Ratio	CMRR	$V_{in}=20\text{kHz}$, 1Vp-p	-	-55	-	dB
Differential Gain	DG	$V_{in}=1.0\text{Vp-p}$, 10step Video Signal	-	0.1	-	%
Differential Phase	DP	$V_{in}=1.0\text{Vp-p}$, 10step Video Signal	-	0.1	-	deg

■TEST CIRCUIT

(When measuring CMR, SW2 of VGND is connected to .SW2 is connected to when measuring other electrical characteristics. When Icc is measured, SW1 of Vout is connected to and 75 Ω is disconnected and opened. SW1 is connected to in other special features.)

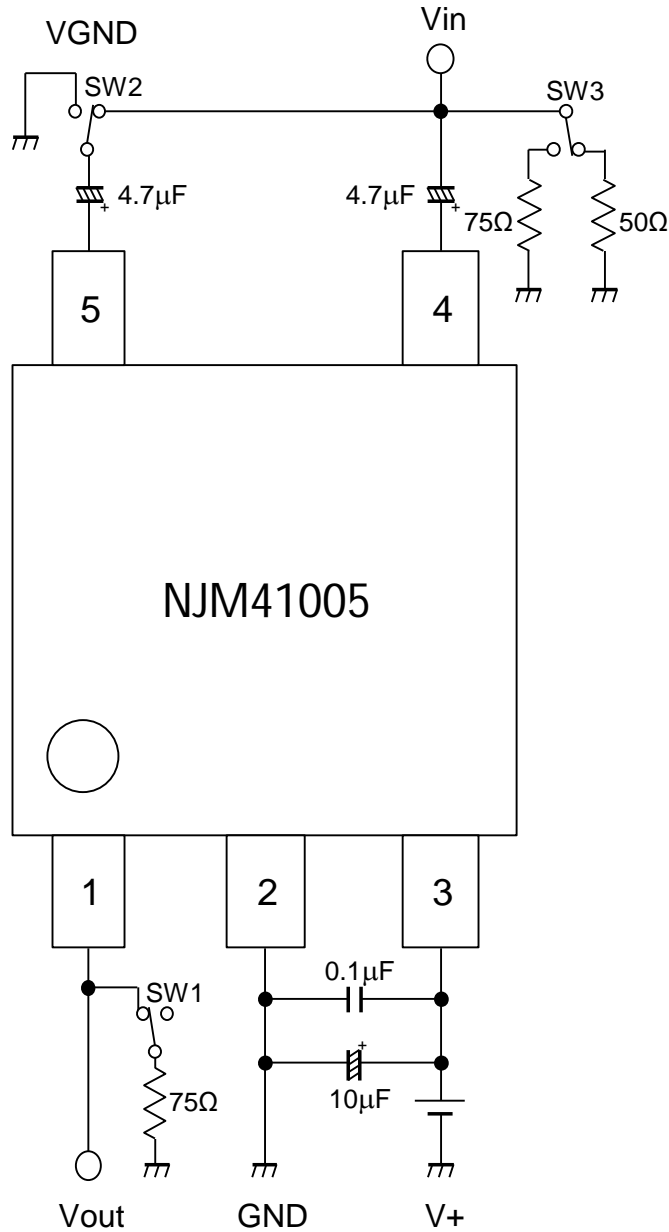

■APPLICATION CIRCUIT 1(Output DC Coupling)

■APPLICATION CIRCUIT 2(Output AC Coupling)

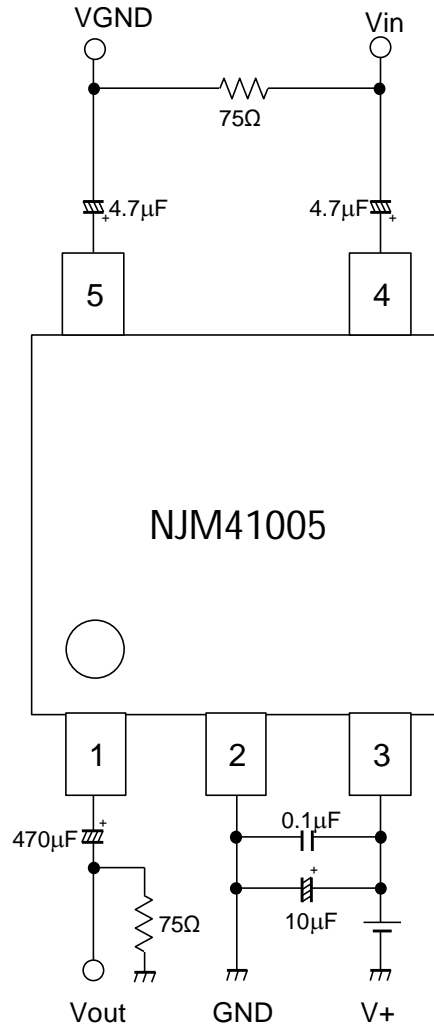
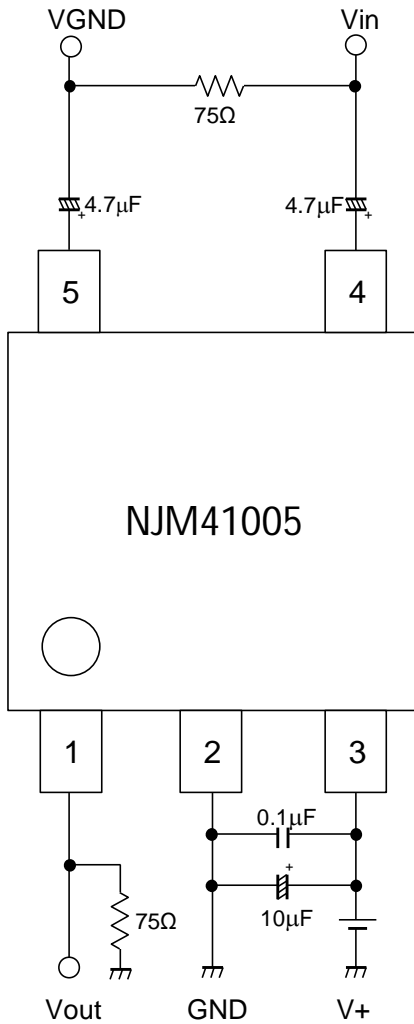

■APPLICATION

When using an external ESD protection resistor at the video input terminal, please connect the same resistance at the VIN terminal (pin 4) and the VGND terminal (pin 5). Please verify with resistance value about 100 Ω.

■ EQUIVALENT CIRCUIT

Pin. No.	Symbol	Function	Inside Equivalent Circuit	Voltage
1	Vout	Video Signal Output		0.5V
2	GND	GND	-	-
3	V+	Power Supply	-	-
4	Vin	Video Signal Input		1.5V
5	VGND	GND Input From source side		2.5V

■ TYPICAL CHARACTERISTICS

Operating Current vs. Supply Voltage

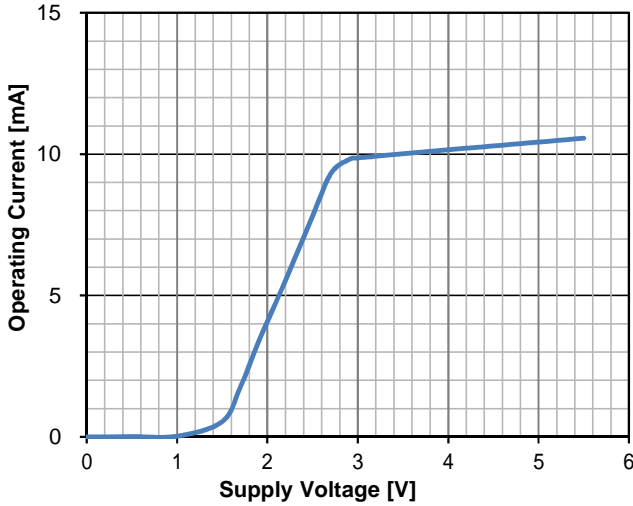

Maximum output voltage vs. Supply Voltage

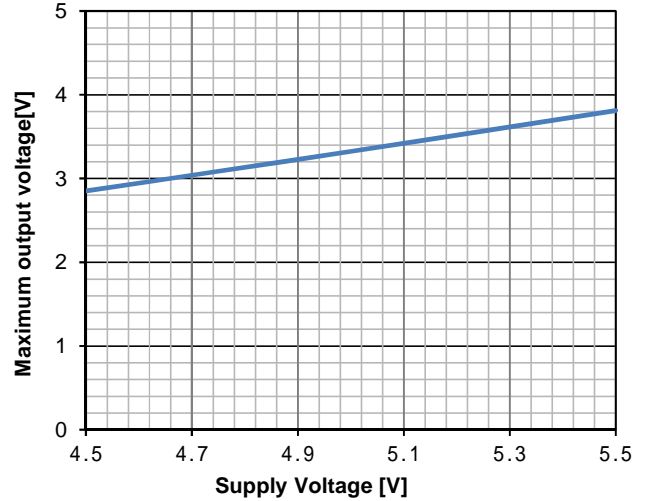

Voltage Gain vs. Supply Voltage
Vin=1.0Vpp 100KHz Sine Signal Input

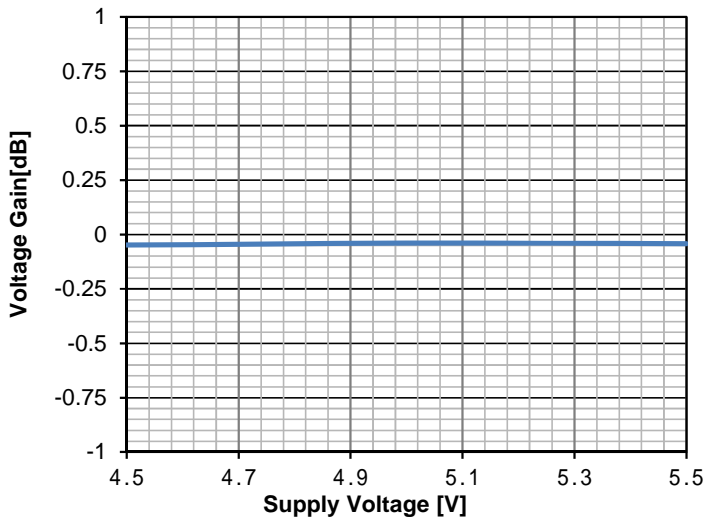

Frequency Characteristic vs. Supply Voltage
Vin=1.0Vpp 10MHz Sine Signal Input

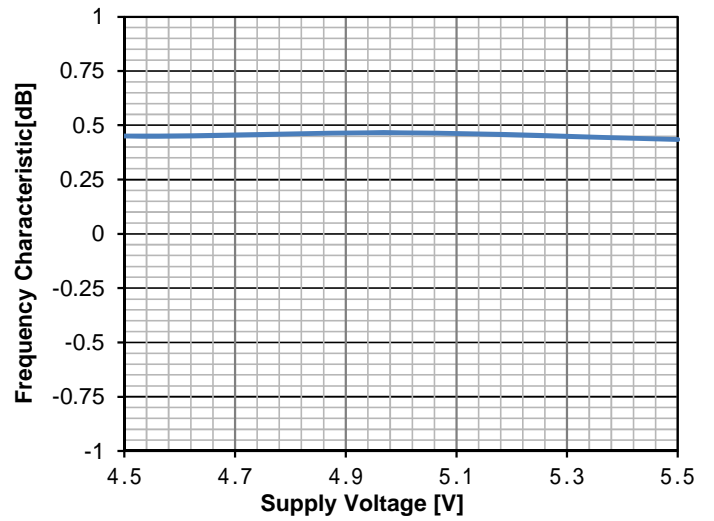

Differential Gain vs. Supply Voltage

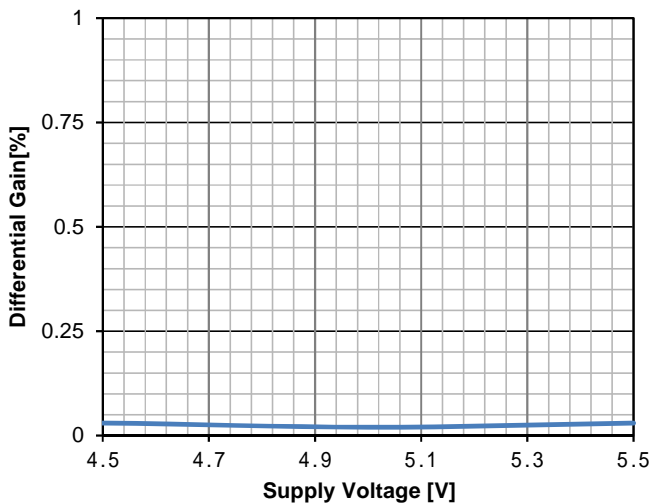

Differential Phase vs. Supply Voltage

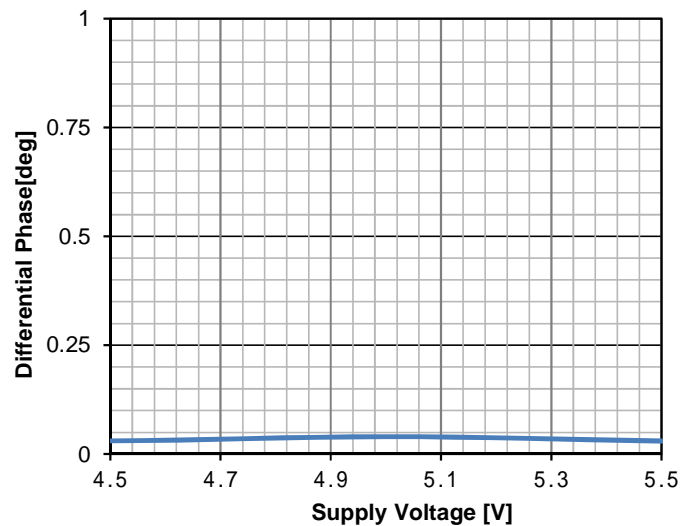

■ TYPICAL CHARACTERISTICS

Common Mode Rejection Ratio vs Supply Voltage

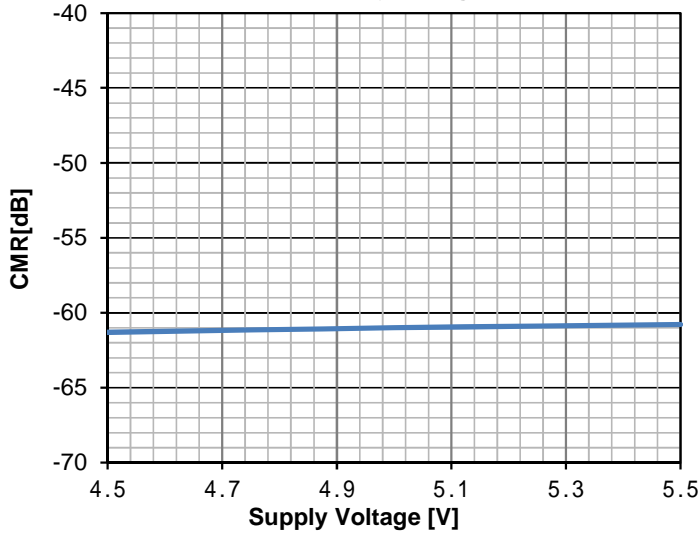

Operating Current vs. Temperature

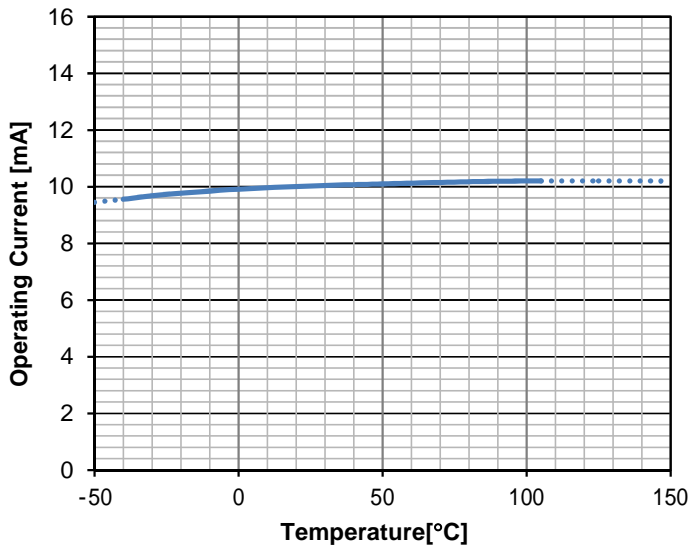

Maximum output voltage vs. Temperature

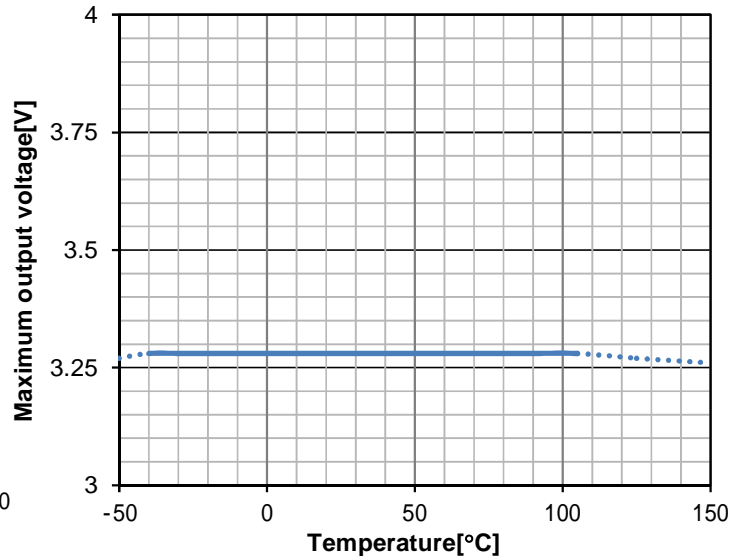

Voltage Gain vs. Temperature
Vin=1.0Vpp 100KHz Sine Signal Input

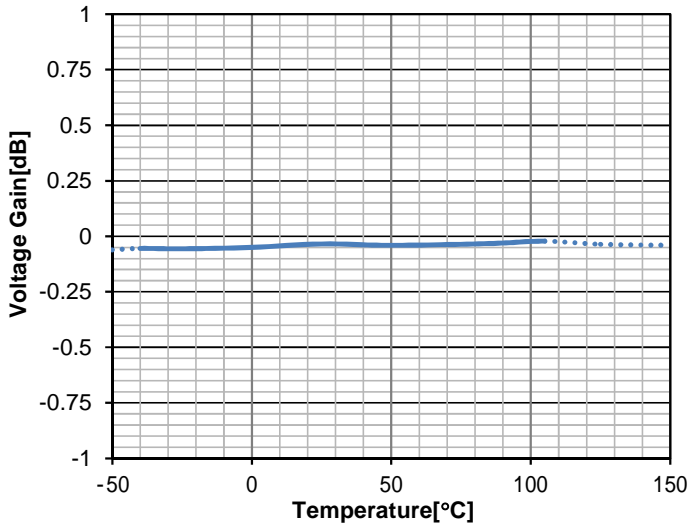

Frequency Characteristic vs. Temperature
Vin=1.0Vpp 10MHz Sine Signal Input

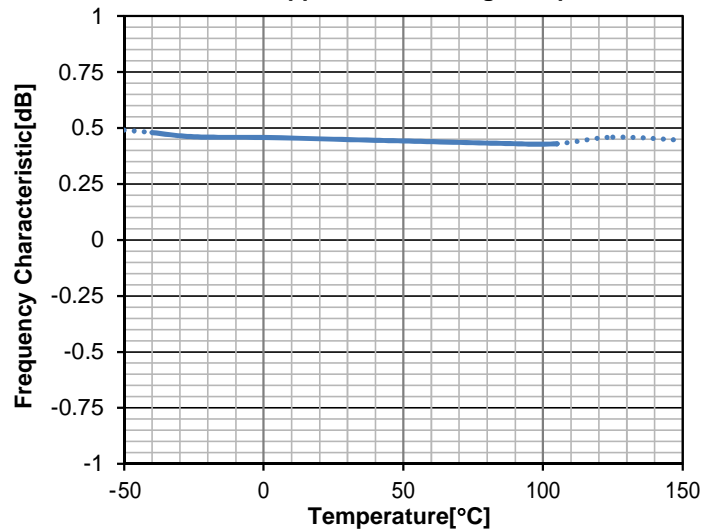

■ TYPICAL CHARACTERISTICS

Differential Gain vs. Temperature

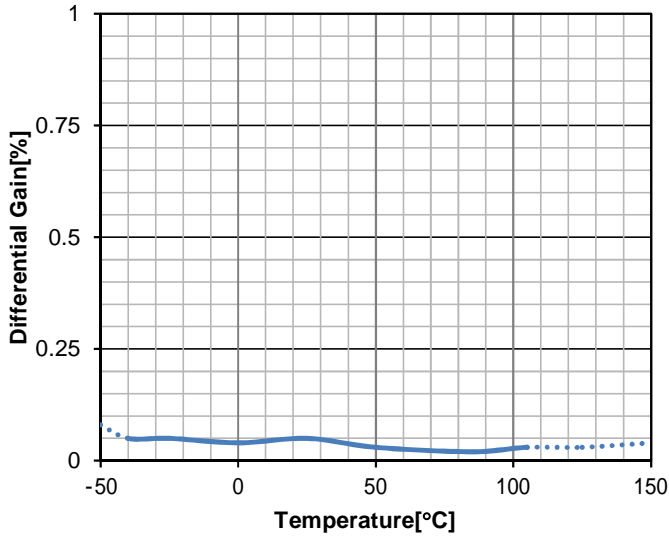

Differential Phase vs. Temperature

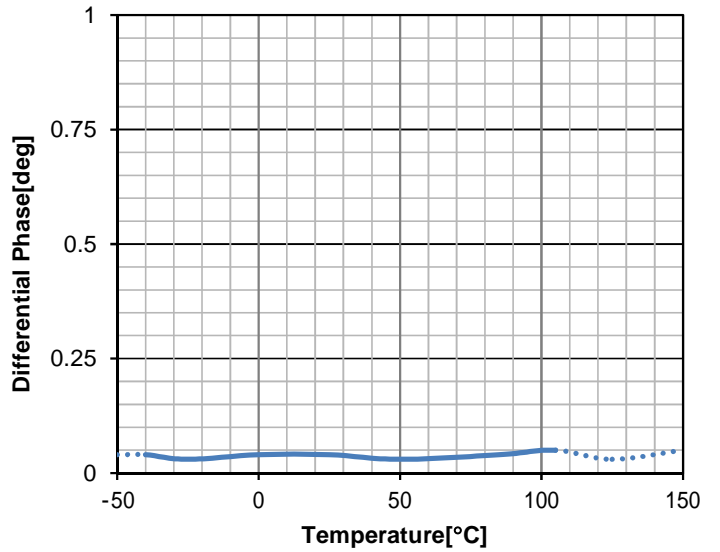

Common Mode Rejection Ratio vs Temperature

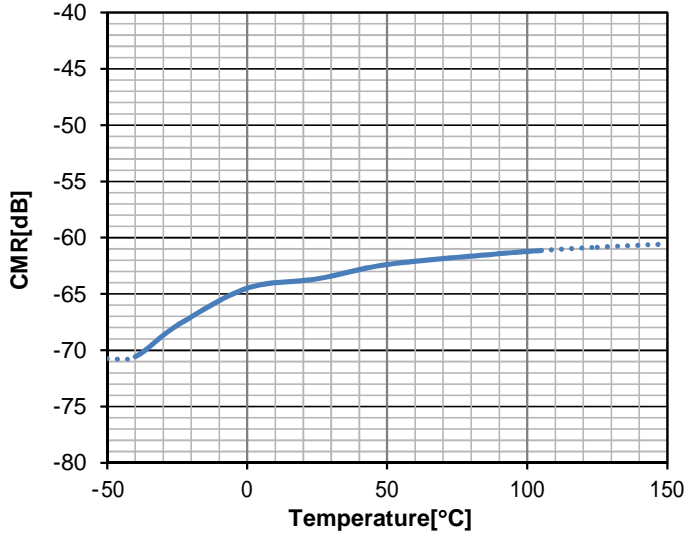

Voltage Gain Vs. Frequency
Vin=1.0Vpp, RL=75ohm, Sine Signal Input

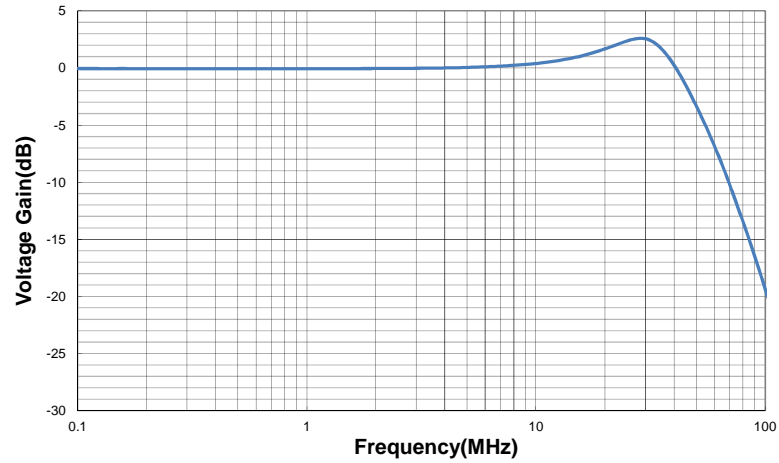

CMR vs Frequency

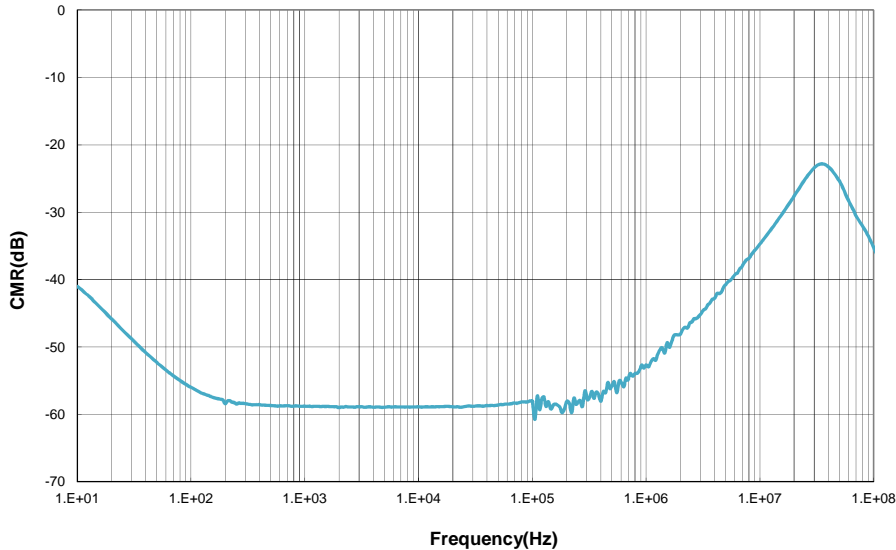

Frequency(Hz)

New Japan Radio Co., Ltd.

PACKAGE DIMENSIONS

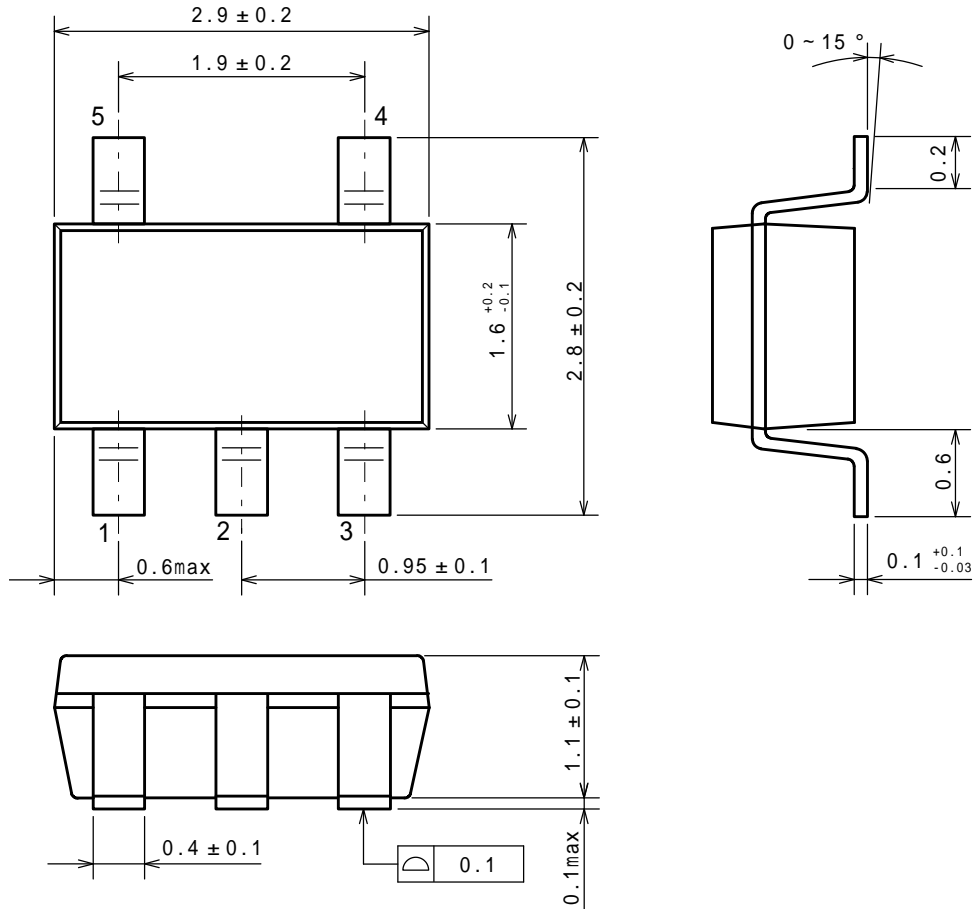

EXAMPLE OF SOLDER PADS DIMENSIONS

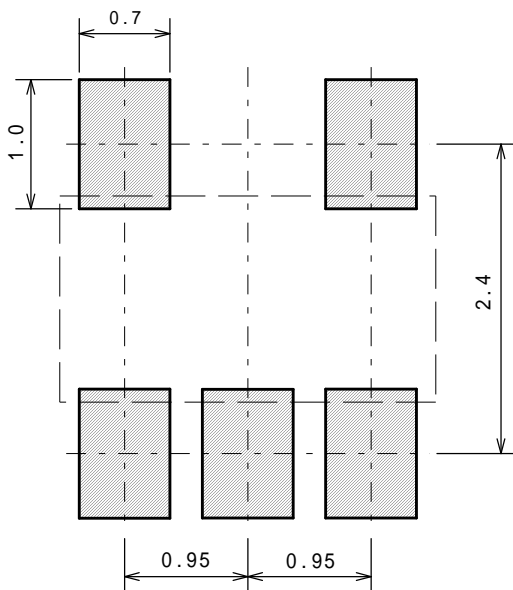

PACKING SPEC

TAPING DIMENSIONS

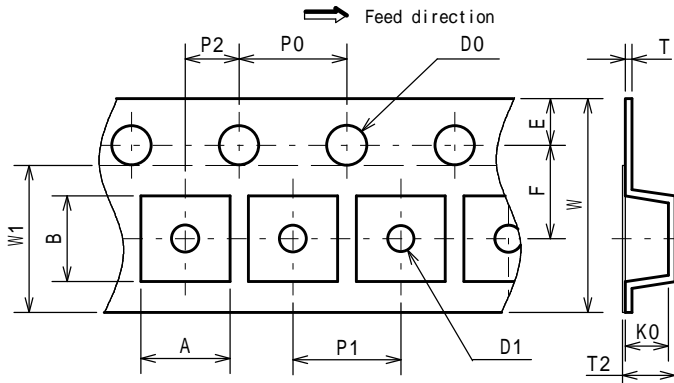

SYMBOL	DIMENSION	REMARKS
A	3.3 ± 0.1	BOTTOM DIMENSION
B	3.2 ± 0.1	BOTTOM DIMENSION
D0	1.55	
D1	1.05	
E	1.75 ± 0.1	
F	3.5 ± 0.05	
P0	4.0 ± 0.1	
P1	4.0 ± 0.1	
P2	2.0 ± 0.05	
T	0.25 ± 0.05	
T2	1.82	
K0	1.5 ± 0.1	
W	8.0 ± 0.3	
W1	5.5	THICKNESS 0.1MAX

REEL DIMENSIONS

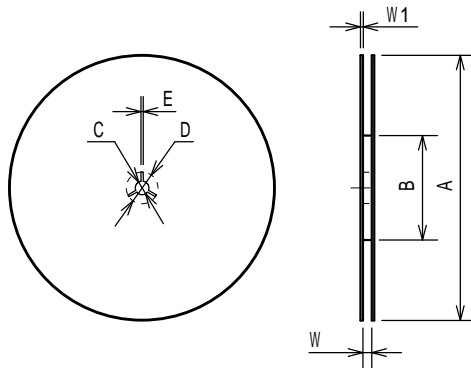

SYMBOL	DIMENSION
A	180 ± 1
B	60 ± 1
C	13 ± 0.2
D	21 ± 0.8
E	2 ± 0.5
W	9 ± 0.5
W1	1.2 ± 0.2

TAPING STATE

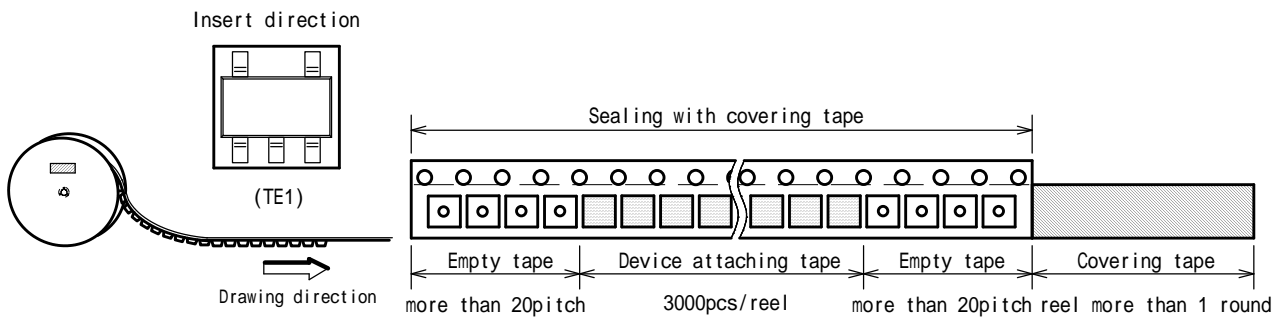

PACKING STATE

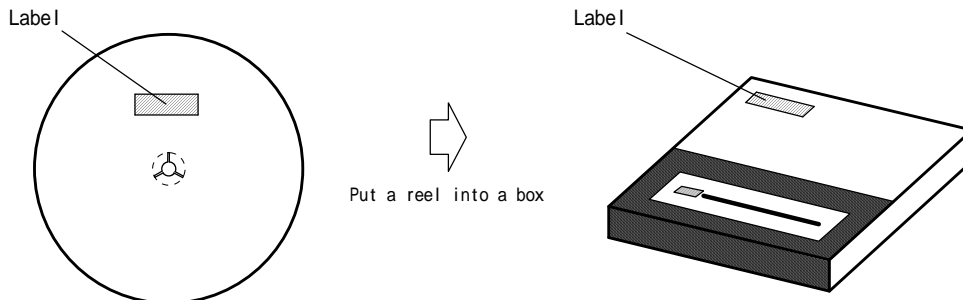

INFRARED REFLOW SOLDERING METHOD

EAE-D1006-000-02

* Recommended reflow soldering procedure

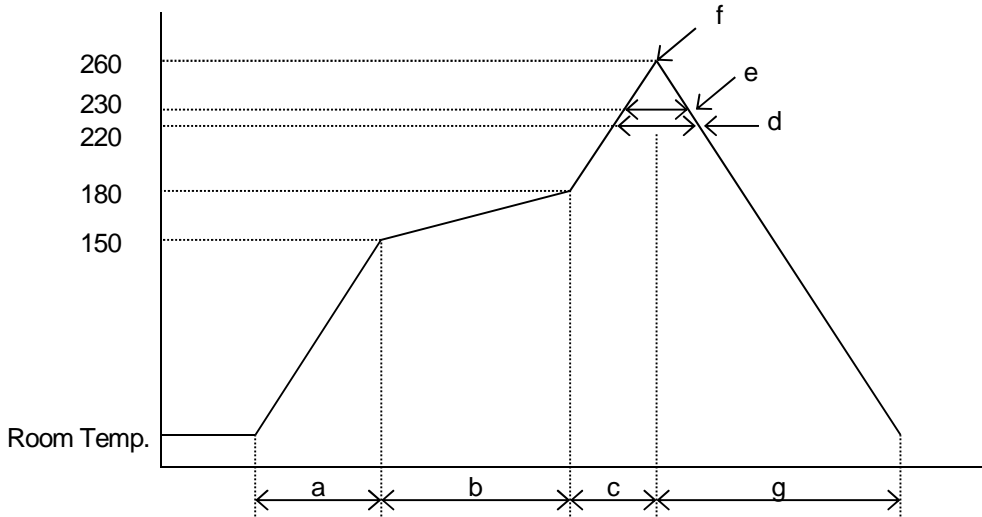

- | | |
|-----------------------------|--------------------|
| a: Temperature ramping rate | : 1 to 4 /s |
| b: Pre-heating temperature | : 150 to 180 |
| time | : 60 to 120s |
| c: Temperature ramp rate | : 1 to 4 /s |
| d: 220 or higher time | : Shorter than 60s |
| e: 230 or higher time | : Shorter than 40s |
| f: Peak temperature | : Lower than 260 |
| g: Temperature ramping rate | : 1 to 6 /s |

The temperature indicates at the surface of mold package.

[CAUTION]

1. New JRC strives to produce reliable and high quality semiconductors. New JRC's semiconductors are intended for specific applications and require proper maintenance and handling. To enhance the performance and service of New JRC's semiconductors, the devices, machinery or equipment into which they are integrated should undergo preventative maintenance and inspection at regularly scheduled intervals. Failure to properly maintain equipment and machinery incorporating these products can result in catastrophic system failures
2. The specifications on this datasheet are only given for information without any guarantee as regards either mistakes or omissions. The application circuits in this datasheet are described only to show representative usages of the product and not intended for the guarantee or permission of any right including the industrial rights. All other trademarks mentioned herein are property of their respective companies.
3. To ensure the highest levels of reliability, New JRC products must always be properly handled. The introduction of external contaminants (e.g. dust, oil or cosmetics) can result in failures of semiconductor products.
4. New JRC offers a variety of semiconductor products intended for particular applications. It is important that you select the proper component for your intended application. You may contact New JRC's Sale's Office if you are uncertain about the products listed in this catalog.
5. Special care is required in designing devices, machinery or equipment which demand high levels of reliability. This is particularly important when designing critical components or systems whose failure can foreseeably result in situations that could adversely affect health or safety. In designing such critical devices, equipment or machinery, careful consideration should be given to amongst other things, their safety design, fail-safe design, back-up and redundancy systems, and diffusion design.
6. The products listed in the catalog may not be appropriate for use in certain equipment where reliability is critical or where the products may be subjected to extreme conditions. You should consult our sales office before using the products in any of the following types of equipment.

Aerospace Equipment
Equipment Used in the Deep sea
Power Generator Control Equipment (Nuclear, Steam, Hydraulic)
Life Maintenance Medical Equipment
Fire Alarm/Intruder Detector
Vehicle Control Equipment (airplane, railroad, ship, etc.)
Various Safety devices

7. New JRC's products have been designed and tested to function within controlled environmental conditions. Do not use products under conditions that deviate from methods or applications specified in this catalog. Failure to employ New JRC products in the proper applications can lead to deterioration, destruction or failure of the products. New JRC shall not be responsible for any bodily injury, fires or accident, property damage or any consequential damages resulting from misuse or misapplication of its products. Products are sold without warranty of any kind, either express or implied, including but not limited to any implied warranty of merchantability or fitness for a particular purpose.
8. Warning for handling Gallium and Arsenic(GaAs) Products (Applying to GaAs MMIC, Photo Reflector). This Products uses Gallium(Ga) and Arsenic(As) which are specified as poisonous chemicals by law. For the prevention of a hazard, do not burn, destroy, or process chemically to make them as gas or power. When the product is disposed, please follow the related regulation and do not mix this with general industrial waste or household waste.
9. The product specifications and descriptions listed in this catalog are subject to change at any time, without notice.

