

### SOT-23 Plastic-Encapsulate Transistors

#### FEATURES

- High Breakdown Voltage

#### MARKING:4D

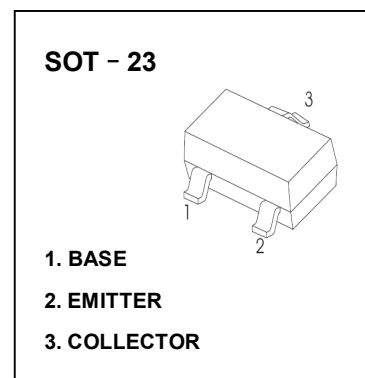

#### MAXIMUM RATINGS (T<sub>a</sub>=25°C unless otherwise noted)

Symbol	Parameter	Value	Unit
V <sub>CBO</sub>	Collector-Base Voltage	-400	V
V <sub>CEO</sub>	Collector-Emitter Voltage	-400	V
V <sub>EBO</sub>	Emitter-Base Voltage	-5	V
I <sub>C</sub>	Collector Current -Continuous	-200	mA
I <sub>CM</sub>	Collector Current -Pulsed	-300	mA
P <sub>C</sub>	Collector Power Dissipation	350	mW
R <sub>θJA</sub>	Thermal Resistance From Junction To Ambient	357	°C/W
T <sub>J</sub>	Junction Temperature	150	°C
T <sub>stg</sub>	Storage Temperature	-55~+150	°C

#### ELECTRICAL CHARACTERISTICS (T<sub>a</sub>=25°C unless otherwise specified)

Parameter	Symbol	Test conditions	Min	Typ	Max	Unit
Collector-base breakdown voltage	V <sub>(BR)CBO</sub>	I <sub>C</sub> =-100μA, I <sub>E</sub> =0	-400			V
Collector-emitter breakdown voltage	V <sub>(BR)CEO</sub>	I <sub>C</sub> =-1mA, I <sub>B</sub> =0	-400			V
Emitter-base breakdown voltage	V <sub>(BR)EBO</sub>	I <sub>E</sub> =-100μA, I <sub>C</sub> =0	-5			V
Collector cut-off current	I <sub>CBO</sub>	V <sub>CB</sub> =-400V, I <sub>E</sub> =0			-0.1	μA
Collector cut-off current	I <sub>CEO</sub>	V <sub>CE</sub> =-400V, I <sub>B</sub> =0			-5	μA
Emitter cut-off current	I <sub>EBO</sub>	V <sub>EB</sub> =-4V, I <sub>C</sub> =0			-0.1	μA
DC current gain	h <sub>FE(1)</sub>	V <sub>CE</sub> =-10V, I <sub>C</sub> =-10mA	80		300	
	h <sub>FE(2)</sub>	V <sub>CE</sub> =-10V, I <sub>C</sub> =-1mA	70			
	h <sub>FE(3)</sub>	V <sub>CE</sub> =-10V, I <sub>C</sub> =-100mA	40			
	h <sub>FE(4)</sub>	V <sub>CE</sub> =-10V, I <sub>C</sub> =-50mA	40			
Collector-emitter saturation voltage	V <sub>CE(sat)1</sub>	I <sub>C</sub> =-10mA, I <sub>B</sub> =-1mA			-0.2	V
	V <sub>CE(sat)2</sub>	I <sub>C</sub> =-50mA, I <sub>B</sub> =-5mA			-0.3	V
Base-emitter saturation voltage	V <sub>BE(sat)</sub>	I <sub>C</sub> =-10mA, I <sub>B</sub> =-1mA			-0.75	V
Transition frequency	f <sub>T</sub>	V <sub>CE</sub> =-20V, I <sub>C</sub> =-10mA, f=30MHz	50			MHz

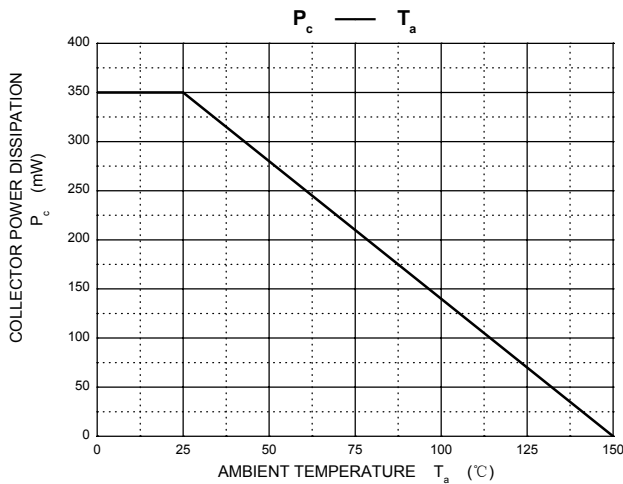
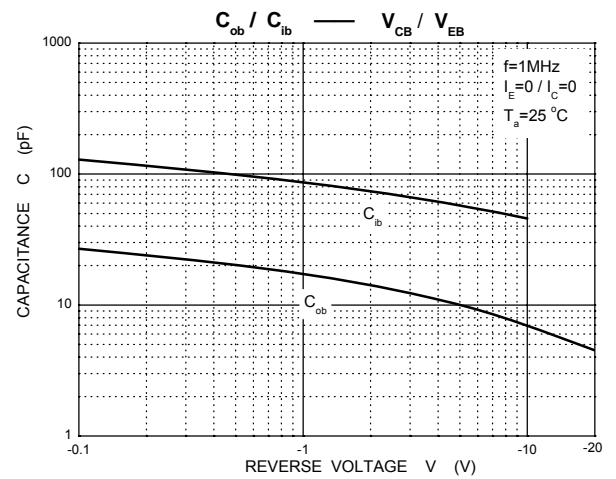
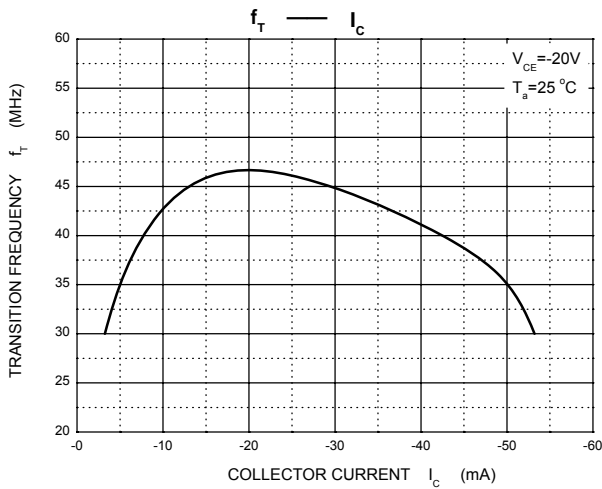
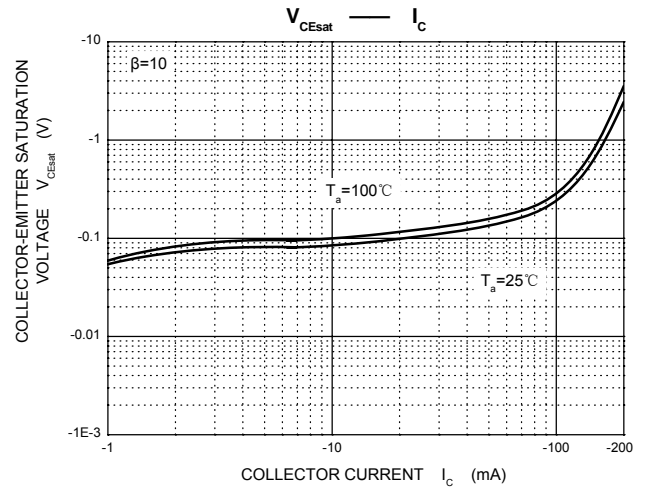
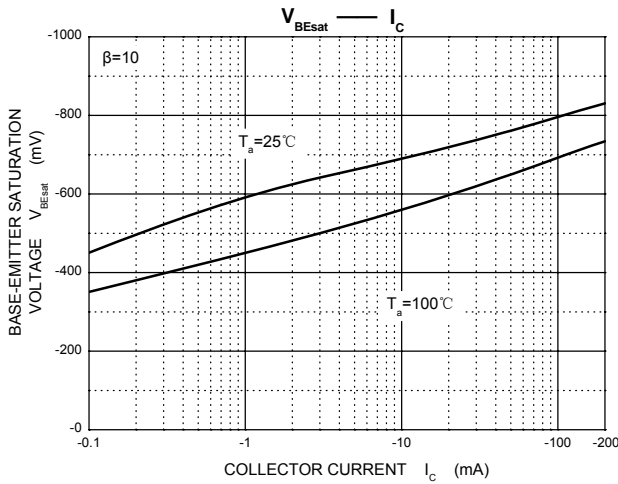
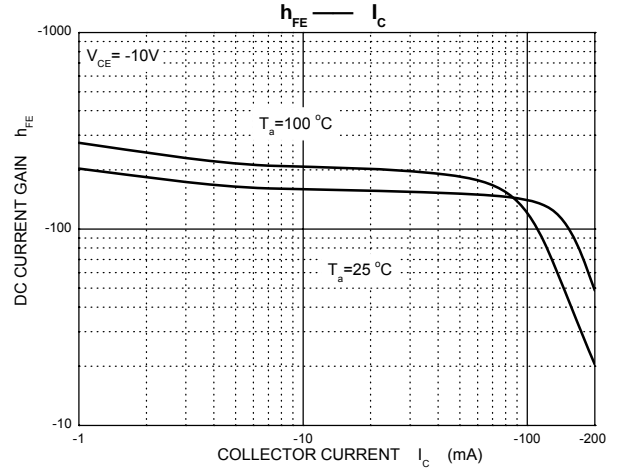
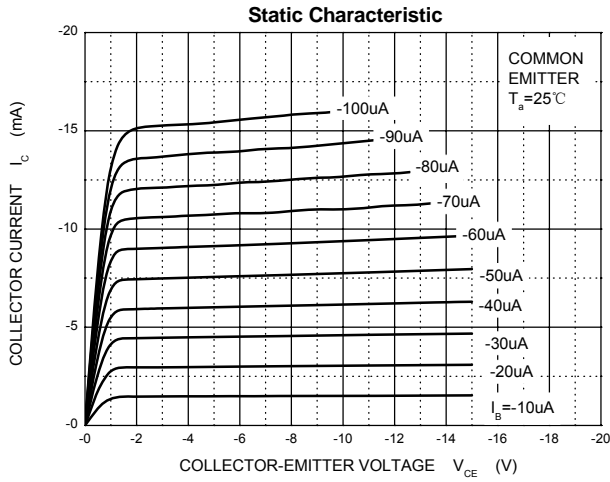

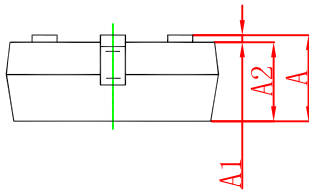
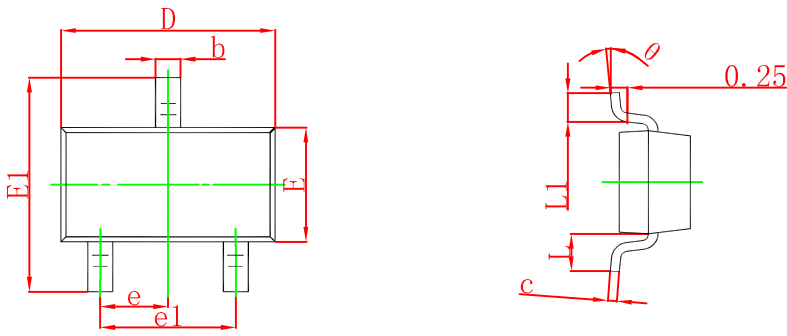

Symbol	Dimensions In Millimeters		Dimensions In Inches	
	Min	Max	Min	Max
A	0.900	1.150	0.035	0.045
A1	0.000	0.100	0.000	0.004
A2	0.900	1.050	0.035	0.041
b	0.300	0.500	0.012	0.020
c	0.080	0.150	0.003	0.006
D	2.800	3.000	0.110	0.118
E	1.200	1.400	0.047	0.055
E1	2.250	2.550	0.089	0.100
e	0.950 TYP		0.037 TYP	
e1	1.800	2.000	0.071	0.079
L	0.550 REF		0.022 REF	
L1	0.300	0.500	0.012	0.020
θ	0°	8°	0°	8°

## SOT-23 Suggested Pad Layout

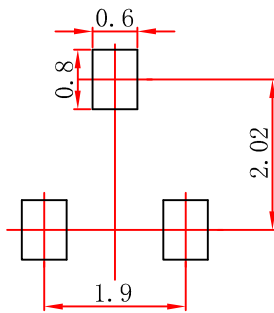

- Note:
1. Controlling dimension: in millimeters.
  2. General tolerance:  $\pm 0.05\text{mm}$ .
  3. The pad layout is for reference purposes only.