

RoHS

IP66-68

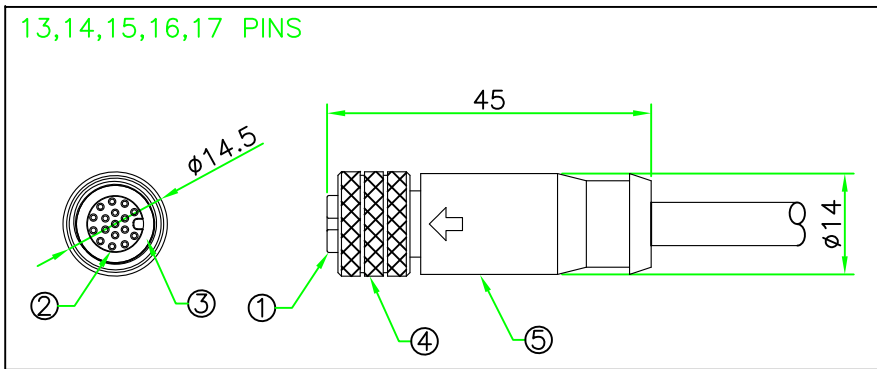
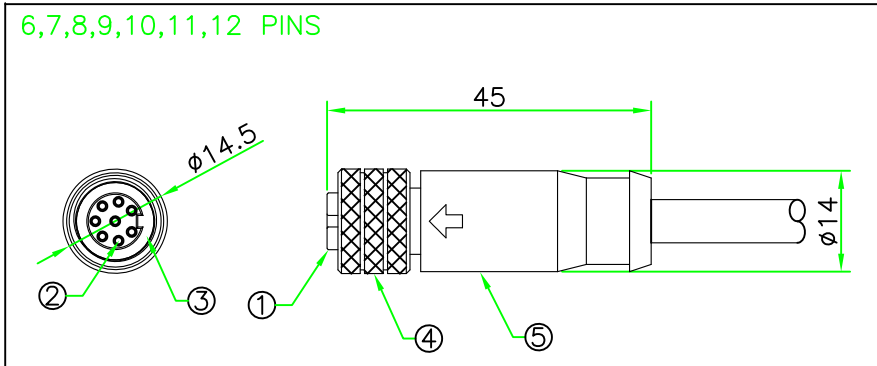
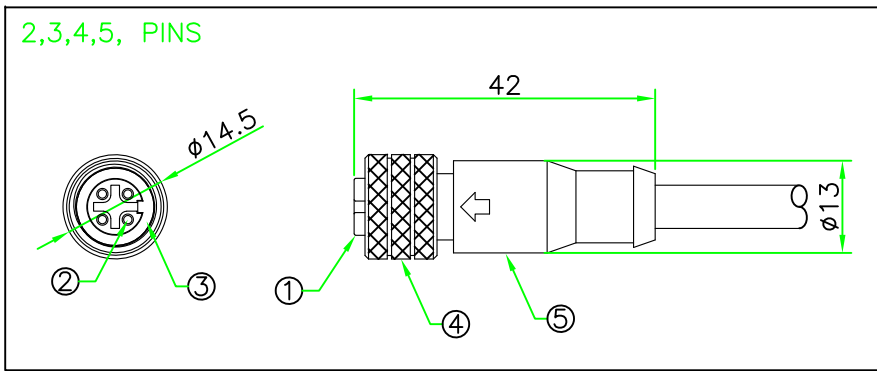

B2

REV.	DESCRIPTION	DATE
A	ISSUE	Dec/22/2009
B	Add 12 Poles	Jan/11/2010
B1	Add Item	May/11/2015
B2	Add 13~17 Pin	Sep/28/2018

NOTES:

- ELECTRICAL CHARACTERISTICS:
 CURRENT RATING: 1.5A / 2A / 4A
 TEMPERATURE RANGE: -20°C TO +80°C
 DIELECTRIC WITHSTANDING VOLTAGE:
 500V AC FOR ONE MINUTE

2. HOW TO ORDER: A12x-M2xxSN

02 - 2 PINS	10 - 10 PINS
03 - 3 PINS	11 - 11 PINS
04 - 4 PINS	12 - 12 PINS
05 - 5 PINS	13 - 13 PINS
06 - 6 PINS	14 - 14 PINS
07 - 7 PINS	15 - 15 PINS
08 - 8 PINS	16 - 16 PINS
09 - 9 PINS	17 - 17 PINS

- I - CURRENT RATING 1.5A
- N - CURRENT RATING 2A
- D - CURRENT RATING 4A

*Cable specification and length can be customized.
 *Pin Assignment Next Page.

No.	PART NAME	DESCRIPTION	COLOR	Q'TY	REMARKS
5	OVERMOLD	PU or PVC.	BLACK	1	
4	RING NUT	Brass, Nickel Plated.		1	
3	O-RING	Viton.	BLACK	1	
2	CONTACT	Brass , 6 u" Gold Plated. Female Contact.		N	
1	CONNECTOR	M12 A-Coding Female Connector Insert. Nylon+GF.	BLACK	1	

HOLIN® HTP ASIA TECHNOLOGY CO., LTD.
 禾凌科技股份有限公司

UNIT: mm	TITLE :	M12 A-Coding Female molded cable Ass'y
SCALE 1:1	P/N:	A12x-M2xxSN
UNLESS OTHERWISE SPECIFIED TOLERANCES: x ±0.5 xx ±0.25 xxx ±0.1 ANGLE ± 1'	DR.	SIBYL
REV. B2	SHEET 1/2	CH. ERIC
	DWG.NO:	A12x-M2xxSN
		AP.

REV.	DESCRIPTION	DATE
A	ISSUE	Dec/22/2009
B	Add 12 Poles	Jan/11/2010
B1	Add Item	May/11/2015
B2	Add 13~17 Pin	Sep/28/2018

B2

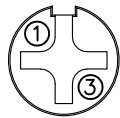

A12D-M202SN

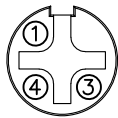

A12D-M203SN

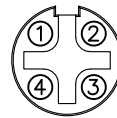

A12D-M204SN

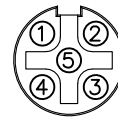

A12D-M205SN

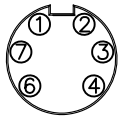

A12N-M206SN

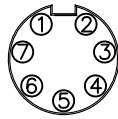

A12N-M207SN

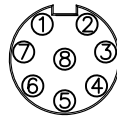

A12N-M208SN

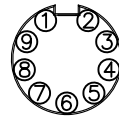

A12I-M209SN

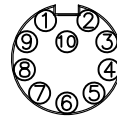

A12I-M210SN

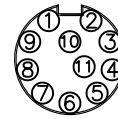

A12I-M211SN

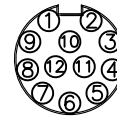

A12I-M212SN

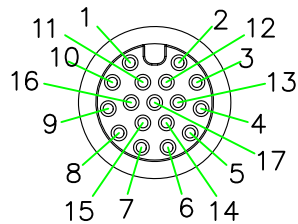

A12I-M213SN

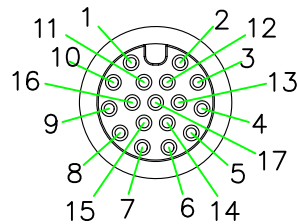

A12I-M214SN

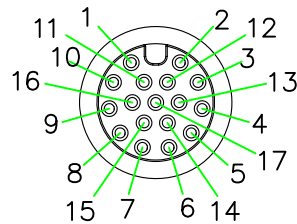

A12I-M215SN

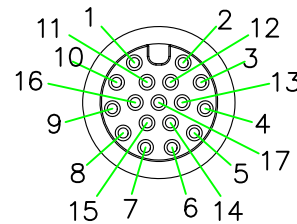

A12I-M216SN

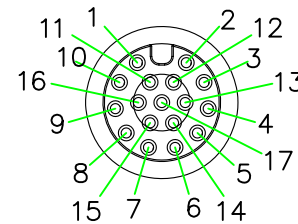

A12I-M217SN

PIN ASSIGNMENT FRONT VIEW
(前視圖)

HOLIN[®] HTP ASIA TECHNOLOGY CO., LTD. 禾凌科技股份有限公司			
	UNIT: mm	TITLE M12 A-Coding Female molded cable Ass'y	
SCALE	2:1		
UNLESS OTHERWISE SPECIFIED TOLERANCES: x ±0.5 xx ±0.25 xxx ±0.1 ANGLE ± 1'		P/N: A12x-M2xxSN	DR. SIBYL
REV. B2	SHEET 2/2	DWG.NO: A12x-M2xxSN	CH. ERIC
			AP.

RoHS

IP66-68

REV.	DESCRIPTION	DATE
A	ISSUE	Jul/21/2015

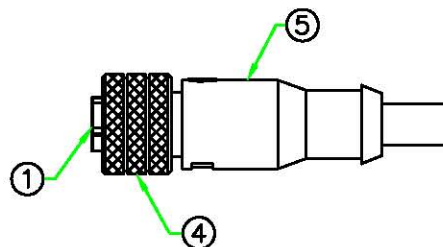
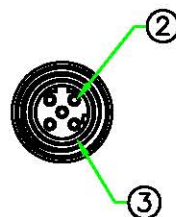
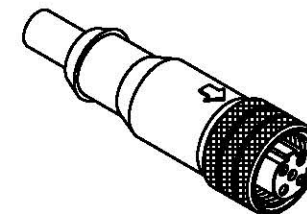
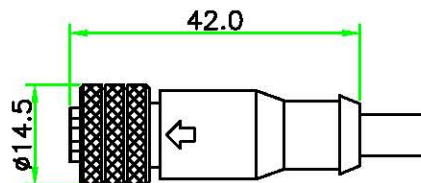

NOTES:

1. ELECTRICAL CHARACTERISTICS:

CURRENT RATING: 4A

TEMPERATURE RANGE: -20°C TO +80°C

DIELECTRIC WITHSTANDING VOLTAGE:

500V AC FOR ONE MINUTE

2. HOW TO ORDER: D12D-M2xxSN

- 02 - 2 PIN
- 03 - 3 PIN
- 04 - 4 PIN
- 05 - 5 PIN

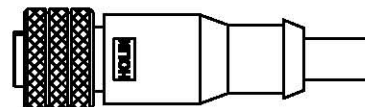

*Cable specification and length can be customized.

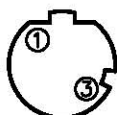

D12D-M202SN

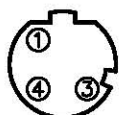

D12D-M203SN

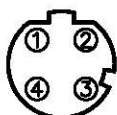

D12D-M204SN



D12D-M205SN

Pin Assignment Front View (前視圖)

5	OVERMOLD	PU or PVC.	BLACK		
4	RING NUT	BRASS, Nickel Plated.		1	
3	O-RING	VITON	BLACK	1	
2	CONTACT	BRASS, 6u" Gold Plated. Female Pin.		N	
1	CONNECTOR	M12 D-Coding Female Connector Insert, NYLON+GF.	BLACK	1	
No.	PART NAME	DESCRIPTION	COLOR	Q'TY	REMARKS

HOLIN® HTP ASIA TECHNOLOGY CO., LTD. 禾凌科技股份有限公司		TITLE	DR.
	UNIT: mm	M12 D-Coding Female Connector Molded Cable Ass'y	Patty
SCALE	1:1	P/N:	ERIC
UNLESS OTHERWISE SPECIFIED TOLERANCES: X ± 0.5 XX ± 0.25 XXX ± 0.1 ANGLE ± 1°		DWG.NO:	AP.
REV.	SHEET	D12D-M2xxSN	
A	1/1		

RoHS

IP66-68

REV.	DESCRIPTION	DATE
A	ISSUE	Oct/11/2018

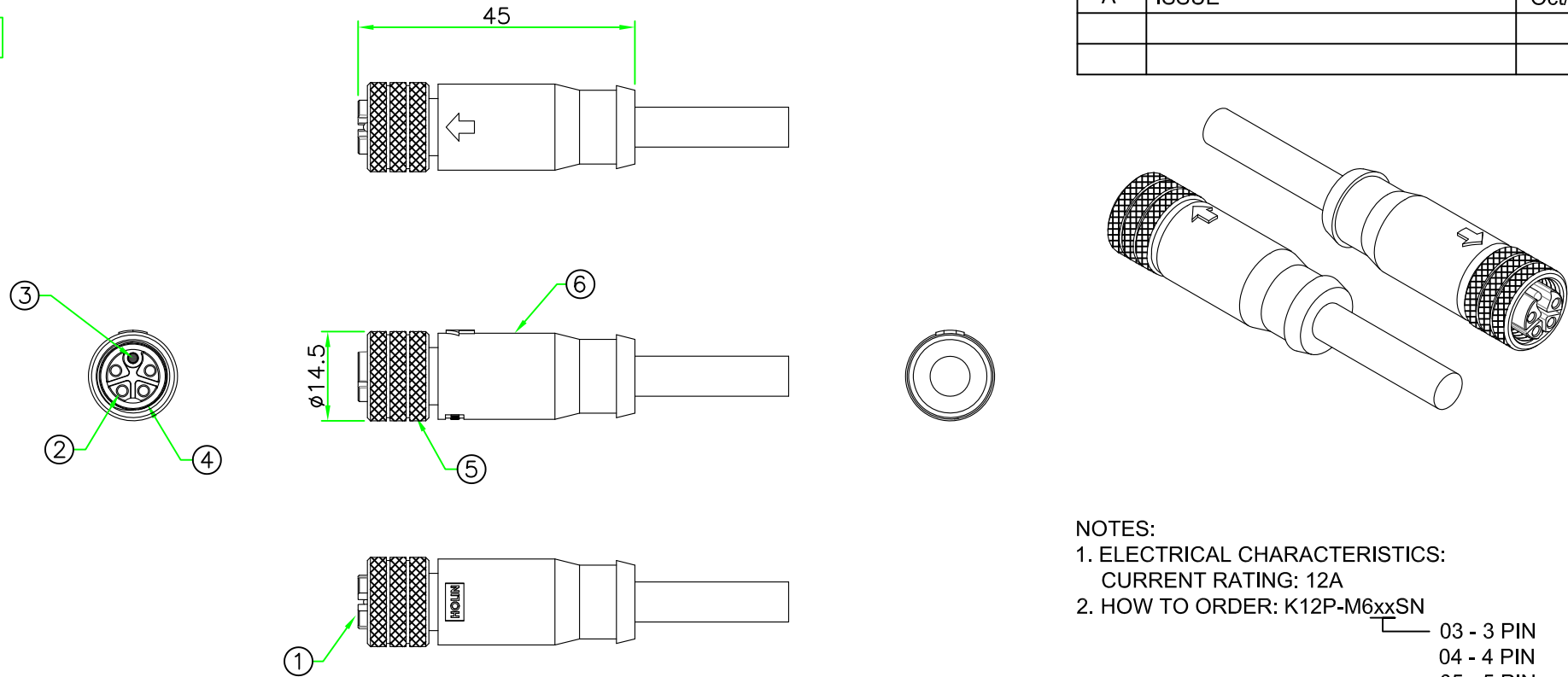

NOTES:

- 1. ELECTRICAL CHARACTERISTICS:
CURRENT RATING: 12A
- 2. HOW TO ORDER: K12P-M6xxSN

- 03 - 3 PIN
- 04 - 4 PIN
- 05 - 5 PIN

*Cable specification and length can be customized.

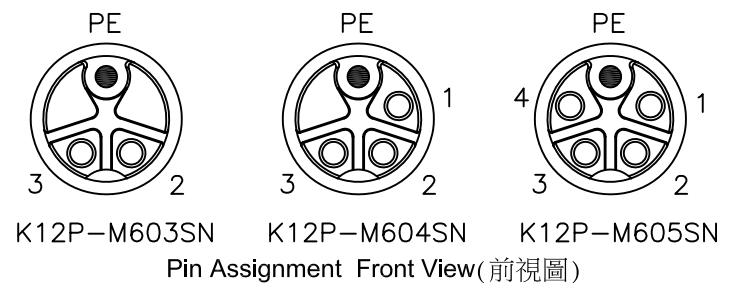

No.	PART NAME	DESCRIPTION	COLOR	Q'TY	REMARKS
6	OVERMOLD	PU or PVC.	BLACK	1	
5	RING NUT	Brass, Nickel Plated.		1	M12F-RN(B6)
4	O-RING	Viton.	BLACK	1	O-0715-VK01
3	CONTACT	Brass , 6 u" Gold Plated. Male Contact.		1	PM1.5SL21.6-01(A)
2	CONTACT	Brass , 6 u" Gold Plated. Female Contact.		N	PF1.5SL20.6-01(A)
1	CONNECTOR	M12 K-Coding Female Connector Insert. Nylon+GF.	BLACK	1	

HOLIN® HTP ASIA TECHNOLOGY CO., LTD.
禾凌科技股份有限公司

UNIT: mm
SCALE 1:1

TITLE : M12 K-Coding Female Connector Molded Cable Ass'y

UNLESS OTHERWISE SPECIFIED TOLERANCES:
X ± 0.5 XX ± 0.25
XXX ± 0.1 ANGLE ± 1'

P/N: K12P-M6xxSN
DWG.NO: K12P-M6xxSN

DR. SIBYL
CH. ERIC
AP.

REV. A SHEET 1/1

RoHS

IP66-68

REV.	DESCRIPTION	DATE
A	ISSUE	Oct/15/2018

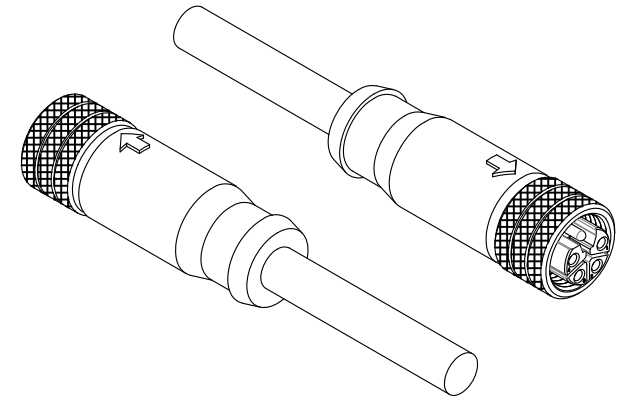
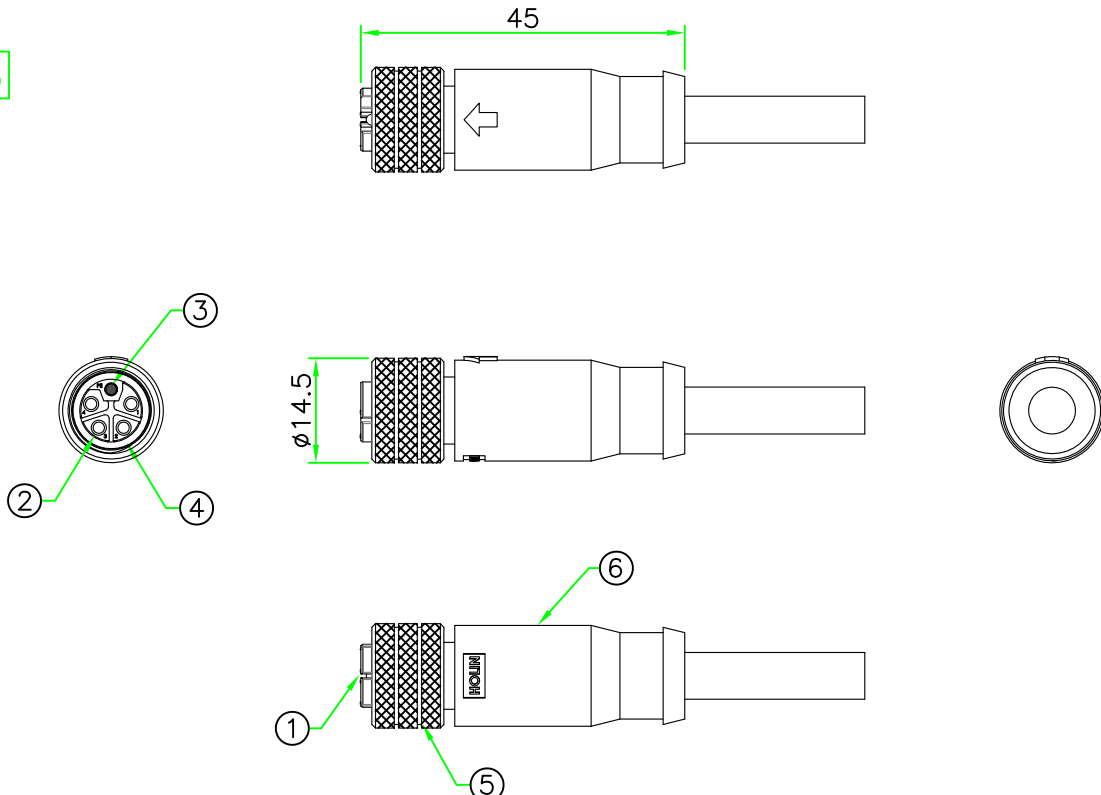

NOTES:

- ELECTRICAL CHARACTERISTICS:
CURRENT RATING: 12A
- HOW TO ORDER: L12P-M6xxSN

- 03 - 3 PIN
- 04 - 4 PIN
- 05 - 5 PIN

*Cable specification and length can be customized.

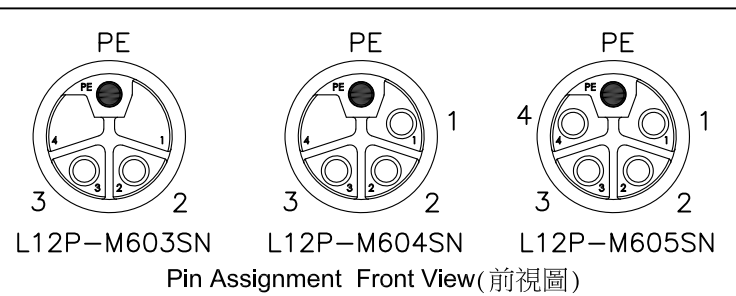

No.	PART NAME	DESCRIPTION	COLOR	Q'TY	REMARKS
6	OVERMOLD	PU or PVC.	BLACK	1	
5	RING NUT	Brass, Nickel Plated.		1	M12F-RN(B6)
4	O-RING	Viton.	BLACK	1	O-0715-VK01
3	CONTACT	Brass , 6 u" Gold Plated. Male Contact.		1	PM1.5SL21.6-01(A)
2	CONTACT	Brass , 6 u" Gold Plated. Female Contact.		N	PF1.5SL20.6-01(A)
1	CONNECTOR	M12 L-Coding Female Connector Insert. Nylon+GF.	BLACK	1	

HOLIN® HTP ASIA TECHNOLOGY CO., LTD.
禾凌科技股份有限公司

UNIT: mm
SCALE 1:1

TITLE : M12 L-Coding Female Connector
Molded Cable Ass'y

UNLESS OTHERWISE SPECIFIED TOLERANCES:
X ± 0.5 XX ± 0.25
XXX ± 0.1 ANGLE ± 1'

P/N: L12P-M6xxSN
DR. SIBYL
CH. ERIC

REV. A SHEET 1/1 DWG.NO: L12P-M6xxSN AP.

RoHS

IP66-68

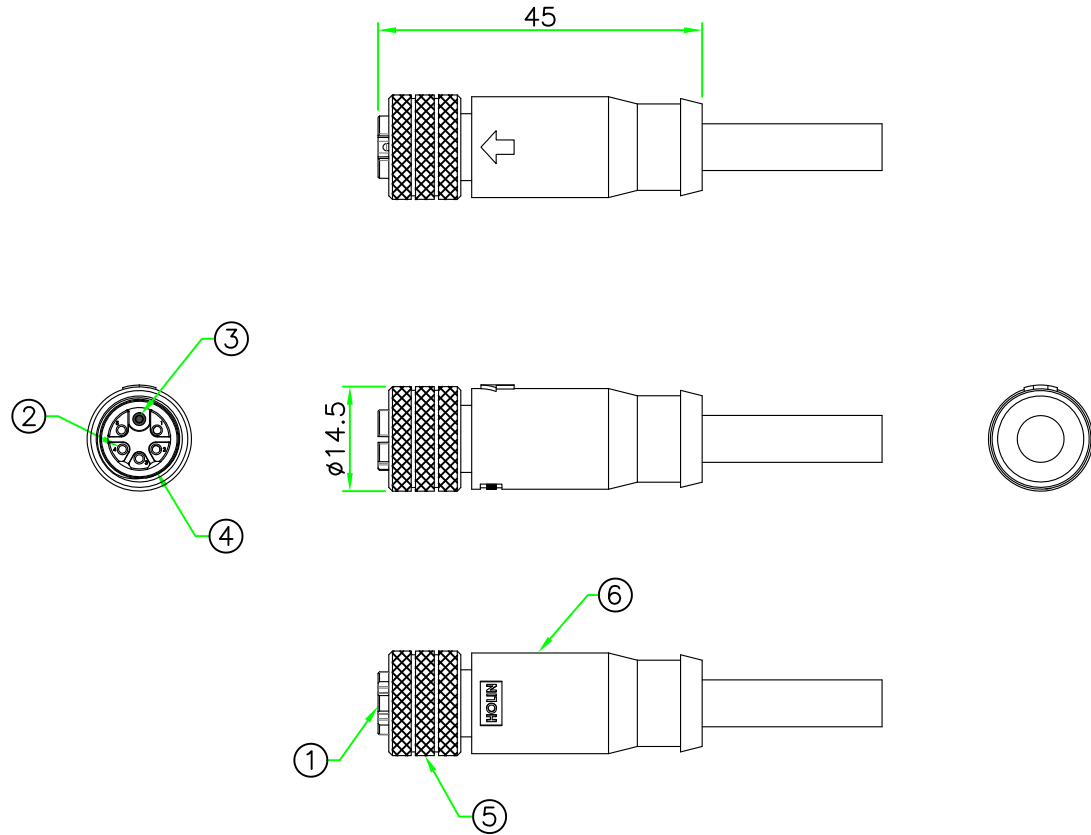

REV.	DESCRIPTION	DATE
A	ISSUE	Oct/15/2018

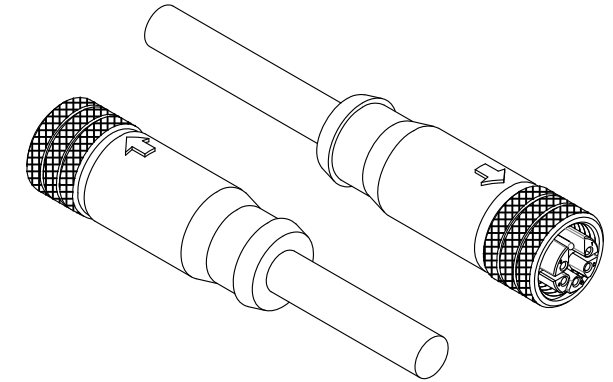

NOTES:



- ELECTRICAL CHARACTERISTICS:
CURRENT RATING: 8A
- HOW TO ORDER: M12D-M6xxSN

- 03 - 3 PIN
- 04 - 4 PIN
- 05 - 5 PIN
- 06 - 6 PIN

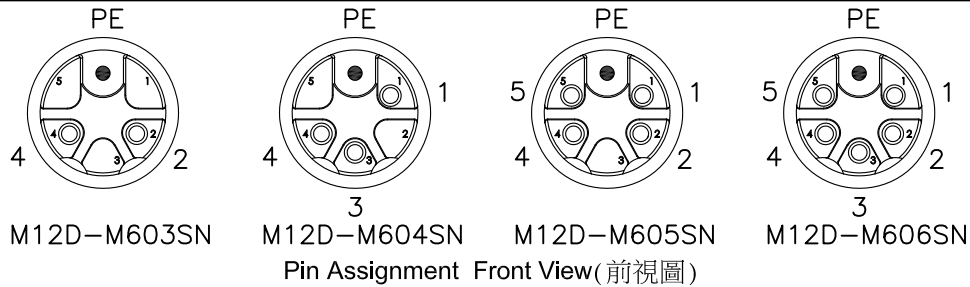
*Cable specification and length can be customized.



No.	PART NAME	DESCRIPTION	COLOR	Q'TY	REMARKS
6	OVERMOLD	PU or PVC.	BLACK	1	
5	RING NUT	Brass, Nickel Plated.		1	M12F-RN(B6)
4	O-RING	Viton.	BLACK	1	O-0715-VK01
3	CONTACT	Brass, 6 u" Gold Plated. Male Contact.		1	M12M-1.0SPL22(B)
2	CONTACT	Brass, 6 u" Gold Plated. Female Contact.		N	M12F-1.0SPL20.5(A1)
1	CONNECTOR	M12 M-Coding Female Connector Insert. Nylon+GF.	BLACK	1	

HOLIN® HTP ASIA TECHNOLOGY CO., LTD. 禾凌科技股份有限公司					
		UNIT: mm	TITLE : M12 M-Coding Female Connector Molded Cable Ass'y		
SCALE	1:1	P/N: M12D-M6xxSN		DR.	SIBYL
UNLESS OTHERWISE SPECIFIED TOLERANCES: X ± 0.5 XX ± 0.25 XXX ± 0.1 ANGLE ± 1°		REV. A	SHEET 1/1	CH.	ERIC
		DWG.NO:	M12D-M6xxSN	AP.	

RoHS

IP66-68

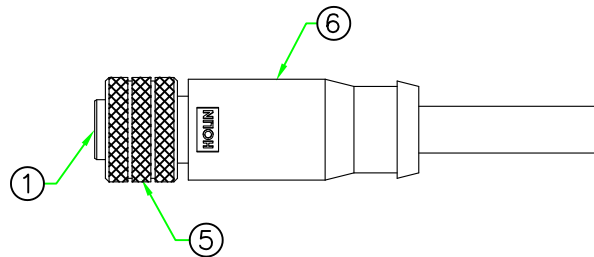
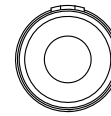
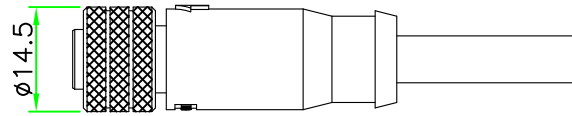
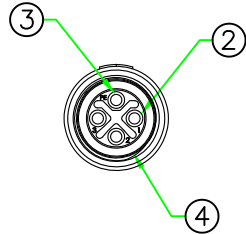
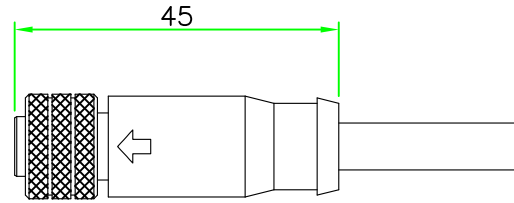

REV.	DESCRIPTION	DATE
A	ISSUE	Oct/15/2018

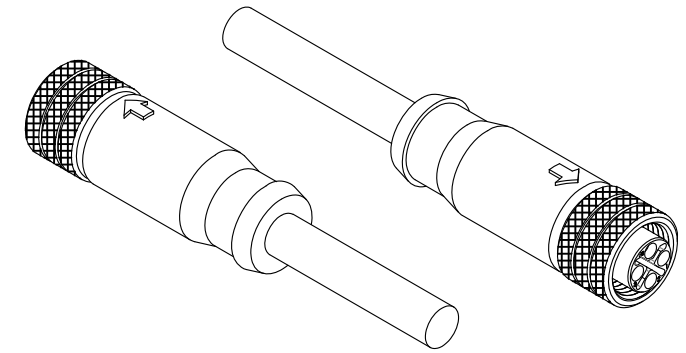

NOTES:

1. ELECTRICAL CHARACTERISTICS:

CURRENT RATING: 12A

2. HOW TO ORDER: S12P-M2xxSN

03 - 3 PIN

04 - 4 PIN

*Cable specification and length can be customized.

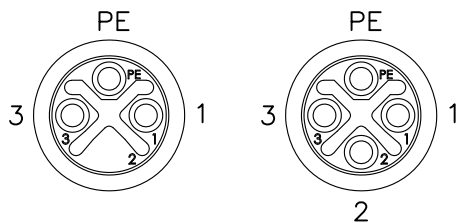

S12P-M203SN

S12P-M204SN

Pin Assignment Front View(前視圖)

No.	PART NAME	DESCRIPTION	COLOR	Q'TY	REMARKS
6	OVERMOLD	PU or PVC.	BLACK	1	
5	RING NUT	Brass, Nickel Plated.		1	M12F-RN(B6)
4	O-RING	Viton.	BLACK	1	O-0715-VK01
3	CONTACT	Brass , 6 u" Gold Plated. Female Contact.		1	PF1.5SL21.5-01(A1)
2	CONTACT	Brass , 6 u" Gold Plated. Female Contact.		N	PF1.5SL21-01(A1)
1	CONNECTOR	M12 S-Coding Female Connector Insert. Nylon+GF.	BLACK	1	

HOLIN® HTP ASIA TECHNOLOGY CO., LTD.
禾凌科技股份有限公司

	UNIT: mm	TITLE : M12 S-Coding Female Connector Molded Cable Ass'y
	SCALE 1:1	
UNLESS OTHERWISE SPECIFIED TOLERANCES: X ± 0.5 XX ± 0.25 XXX ± 0.1 ANGLE ± 1'		P/N: S12P-M2xxSN
REV. A	SHEET 1/1	DWG.NO: S12P-M2xxSN
		DR. SIBYL CH. ERIC AP.

RoHS

IP66-68

REV.	DESCRIPTION	DATE
A	ISSUE	Oct/15/2018

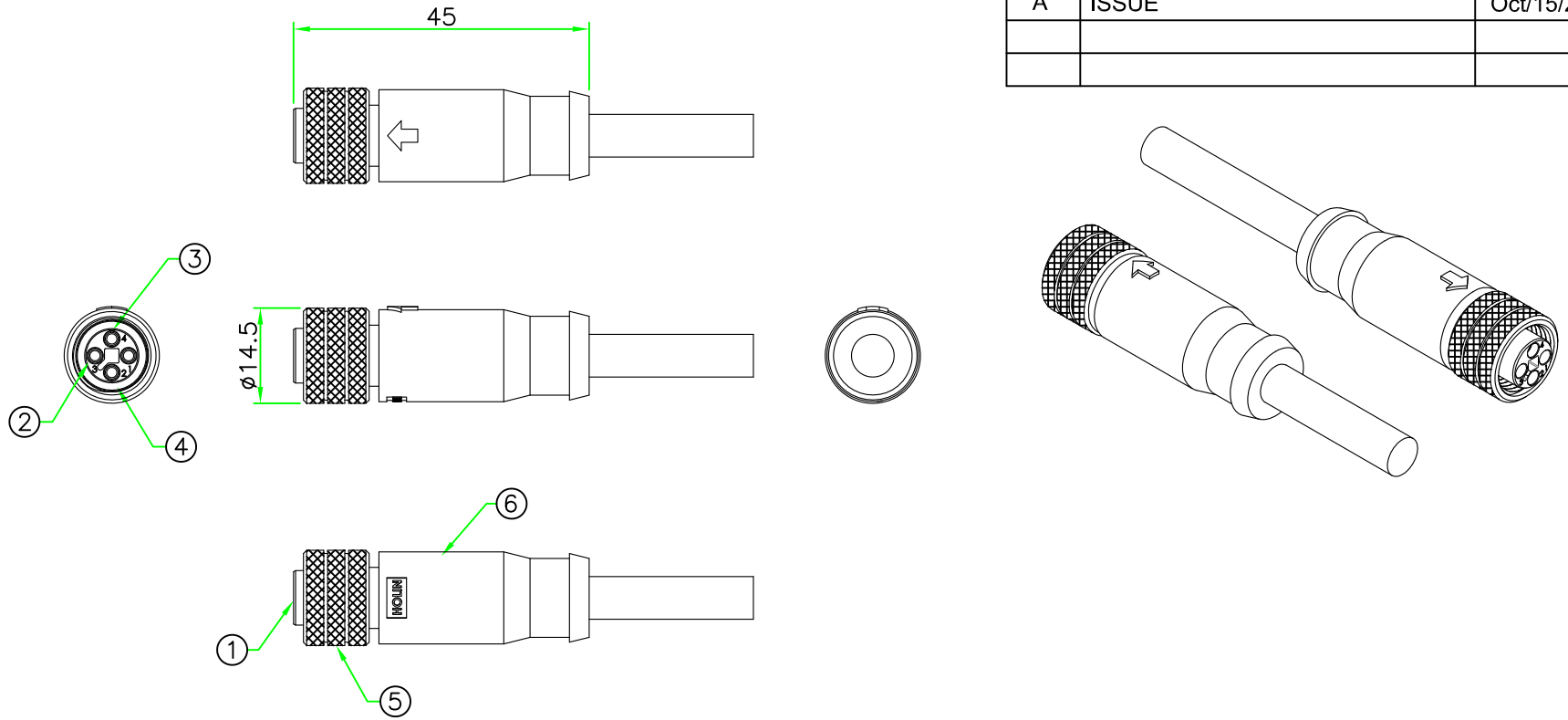

*Cable specification and length can be customized.

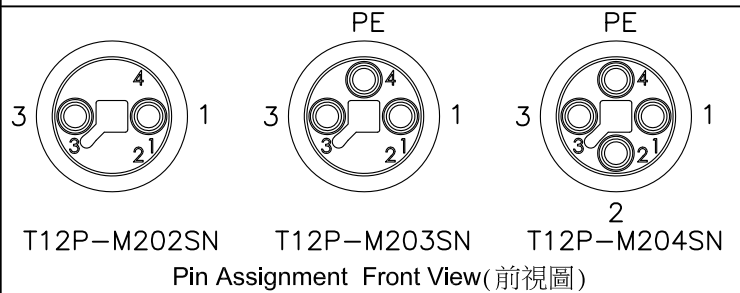

NOTES:

1. ELECTRICAL CHARACTERISTICS:

CURRENT RATING: 12A

2. HOW TO ORDER: T12P-M2xxSN

02 - 2 PIN

03 - 3 PIN

04 - 4 PIN

6	OVERMOLD	PU or PVC.	BLACK	1	
5	RING NUT	Brass, Nickel Plated.		1	M12F-RN(B6)
4	O-RING	Viton.	BLACK	1	O-0715-VK01
3	CONTACT	Brass , 6 u" Gold Plated. Female Contact.		1	PF1.5SL21.5-01(A1)
2	CONTACT	Brass , 6 u" Gold Plated. Female Contact.		N	PF1.5SL21-01(A1)
1	CONNECTOR	M12 T-Coding Female Connector Insert. Nylon+GF.	BLACK	1	
No.	PART NAME	DESCRIPTION	COLOR	Q'TY	REMARKS

HOLIN® HTP ASIA TECHNOLOGY CO., LTD.
禾凌科技股份有限公司

	UNIT: mm	TITLE : M12 T-Coding Female Connector Molded Cable Ass'y
SCALE	1:1	
UNLESS OTHERWISE SPECIFIED TOLERANCES: X ± 0.5 XX ± 0.25 XXX ± 0.1 ANGLE ± 1'		P/N: T12P-M2xxSN
REV. A	SHEET 1/1	DWG.NO: T12P-M2xxSN
		DR. SIBYL CH. ERIC AP.

IP66-68

RoHS

REV.	DESCRIPTION	DATE
A	ISSUE	Feb/26/2009

- NOTES:
- ELECTRICAL CHARACTERISTICS:
 CURRENT RATING: <1.5A
 TEMPERATURE RANGE: -25°C TO +85°C
 DIELECTRIC WITHSTANDING VOLTAGE:
 500V AC FOR ONE MINUTE
 - HOW TO ORDER: X12X-M2XXSN

08 - 8 PINS

1 - CURRENT RATING < 1.5A

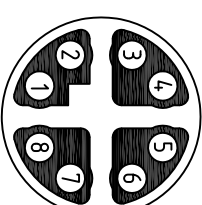
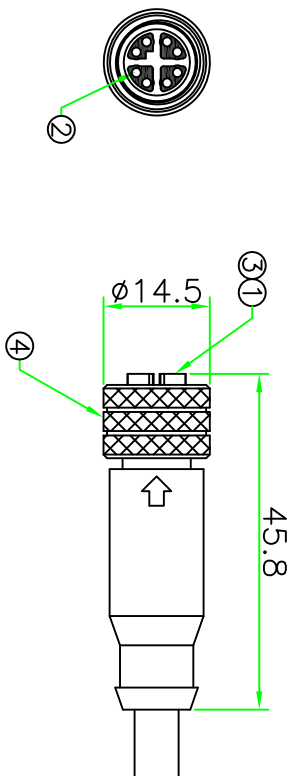

X121-M208SN

Pin Assignment Front View

HOLIN HTP ASIA TECHNOLOGY CO., LTD.
 禾凌科技 股份有限公司

*Cable specification and length can be customized.

No.	PART NAME	DESCRIPTION	COLOR	QTY	REMARKS
4	RING NUT	BRASS, NICKEL PLATED.		1	
3	O-RING	VITON.	BLACK	1	
2	CONTACT	BRASS , Female pin ,6 u" Gold plated .		8	
1	CONNECTOR	M12 Female connector insert.	BLACK	1	

SCALE UNLESS OTHERWISE SPECIFIED TOLERANCES: X ± 0.25 XXX ± 0.05 ANGLE ± 1° REV. SHEET 1/1	UNIT: mm 1:1	TITLE M12 X-Coding FEMALE molded cable Ass'y	P/N: X121-M208SN	DWG.NO: X121-M208SN	DR: <i>Stunkley</i> CH: <i>ESJTC</i> AP:
---	-----------------	--	---------------------	------------------------	--