



2SA1507

PNP SILICON TRANSISTOR

SWITCHING TRANSISTOR

■ APPLICATIONS

* Color TV audio output, converters, inverters

■ FEATURES

- * High breakdown voltage
- * Large current capacitance
- * High-speed switching

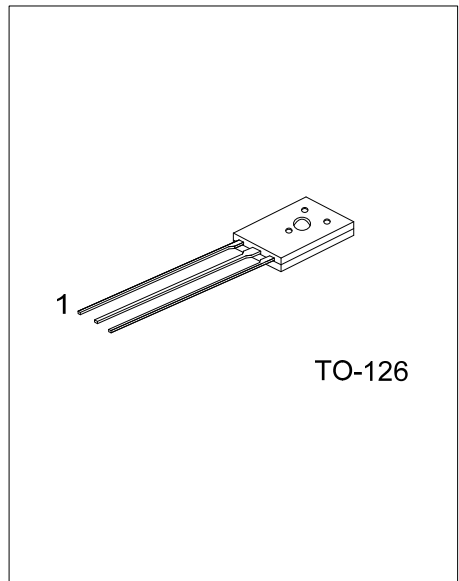

■ ORDERING INFORMATION

Ordering Number		Package	Pin Assignment			Packing
Lead Free	Halogen Free		1	2	3	
2SA1507L-T60-K	2SA1507G-T60-K	TO-126	E	C	B	Bulk

Note: Pin Assignment: E: Emitter C: Collector B: Base

<p>2SA1507G-T60-K</p> <p>(1) Packing Type</p> <p>(2) Package Type</p> <p>(3) Green Package</p>	<p>(1) K: Bulk</p> <p>(2) T60: TO-126</p> <p>(3) G: Halogen Free and Lead Free, L: Lead Free</p>
--	--

■ MARKING

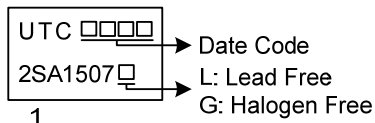

■ ABSOLUTE MAXIMUM RATING ($T_A=25^\circ\text{C}$, unless otherwise specified)

PARAMETER	SYMBOL	RATINGS	UNIT
Collector-Base Voltage	V_{CBO}	-180	V
Collector-emitter voltage	V_{CEO}	-160	V
Emitter-Base Voltage	V_{EBO}	-6	V
Collector Current	I_C	-1.5	A
Collector Current (Peak)	I_{CP}	-2.5	A
Collector Dissipation	P_C	1.5	W
Collector Dissipation ($T_C=25^\circ\text{C}$)		10	W
Junction Temperature	T_J	+150	$^\circ\text{C}$
Storage Temperature	T_{STG}	-55 ~ +150	$^\circ\text{C}$

Note Absolute maximum ratings are those values beyond which the device could be permanently damaged.

Absolute maximum ratings are stress ratings only and functional device operation is not implied.

■ ELECTRICAL CHARACTERISTICS ($T_A=25^\circ\text{C}$, unless otherwise specified)

PARAMETER	SYMBOL	TEST CONDITIONS	MIN	TYP	MAX	UNIT
Collector-to-Base Breakdown Voltage	$V_{(BR)CBO}$	$I_C=-10\mu\text{A}$, $I_E=0$	-180			V
Collector-to-Base Breakdown Voltage	$V_{(BR)CEO}$	$I_C=-1\text{mA}$, $R_{BE}=\infty$	-160			V
Emitter-to-Base Breakdown Voltage	$V_{(BR)EBO}$	$I_C=0$, $I_E=-10\mu\text{A}$	-6			V
Collector Cut-Off Current	I_{CBO}	$V_{CB}=-120\text{V}$, $I_E=0$			-0.1	μA
Emitter Cut-Off Current	I_{EBO}	$V_{EB}=-4\text{V}$, $I_C=0$			-0.1	μA
DC Current Gain	h_{FE1}	$V_{CE}=-5\text{V}$, $I_C=-100\text{mA}$	100		400	
	h_{FE2}	$V_{CE}=-5\text{V}$, $I_C=-10\text{mA}$	90			
Collector-Emitter Saturation Voltage	$V_{CE(sat)}$	$I_C=-500\text{mA}$, $I_B=-50\text{mA}$		-0.2	-0.5	V
Base-Emitter Saturation Voltage	$V_{BE(sat)}$	$I_C=-500\text{mA}$, $I_B=-50\text{mA}$		-0.83	-1.2	V
Gain Bandwidth Product	f_T	$V_{CE}=-10\text{V}$, $I_C=-50\text{mA}$		120		MHz
Output Capacitance	C_{ob}	$V_{CB}=-10\text{V}$, $f=1\text{MHz}$		22		pF
Turn-On Time	t_{on}	See specified Test Circuit		0.04		μs
Storage Time	T_{STG}	See specified Test Circuit		0.7		μs
Fall Time	t_f	See specified Test Circuit		0.04		μs

Note: Pulse test: Pulse width=300 μs , Duty Cycle $\leq 2\%$

■ CLASSIFICATION OF h_{FE}

RANK	R	S	T
RANGE	100-200	140-280	200-400

■ SWITCHING TIME TEST CIRCUIT

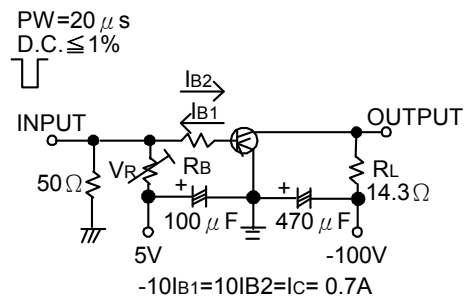

TYPICAL CHARACTERISTICS

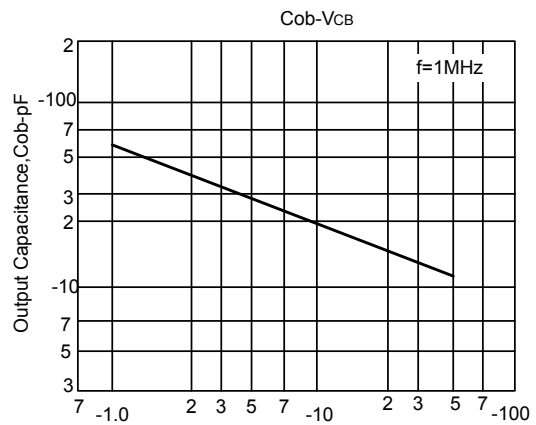
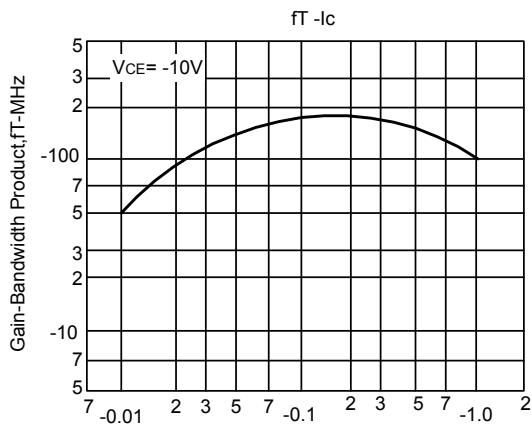
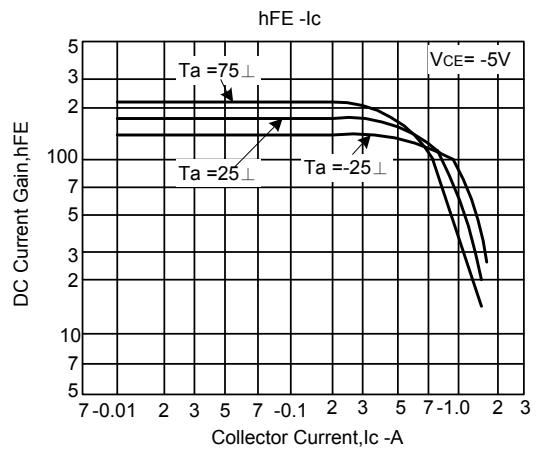
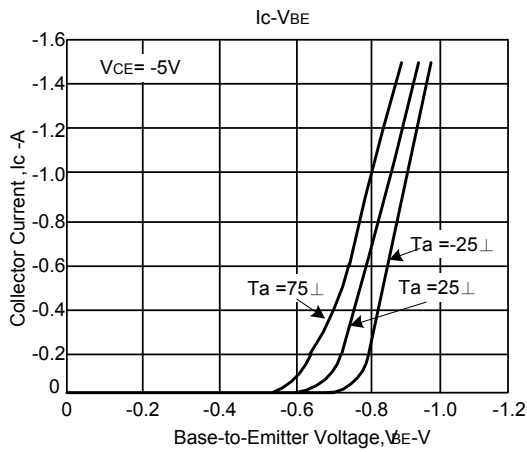
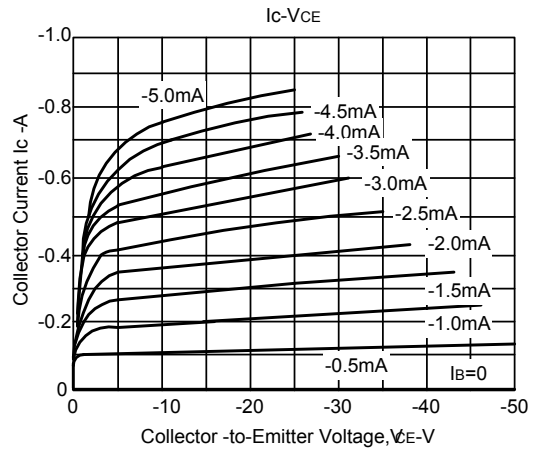
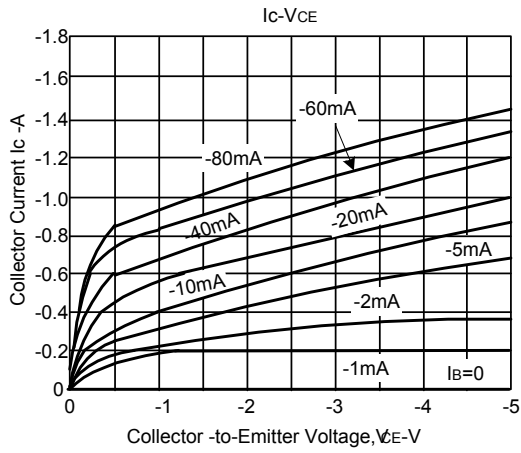

■ TYPICAL CHARACTERISTICS (Cont.)

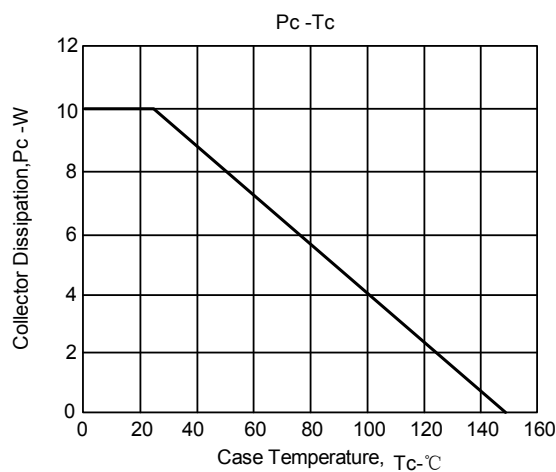
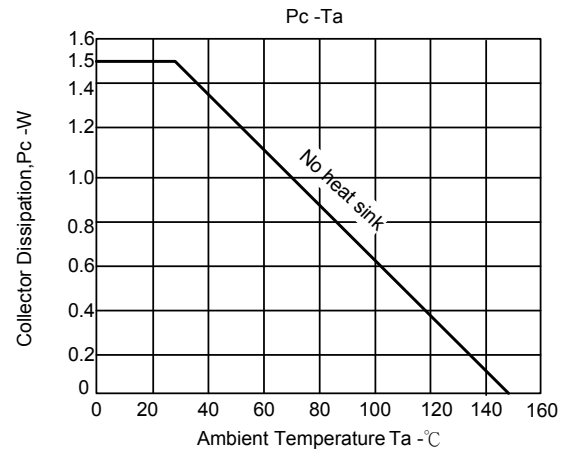
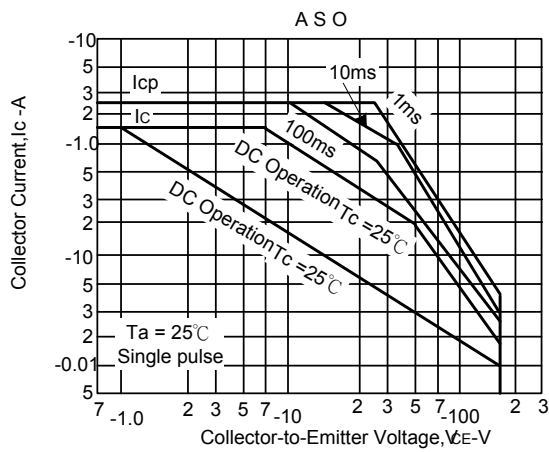
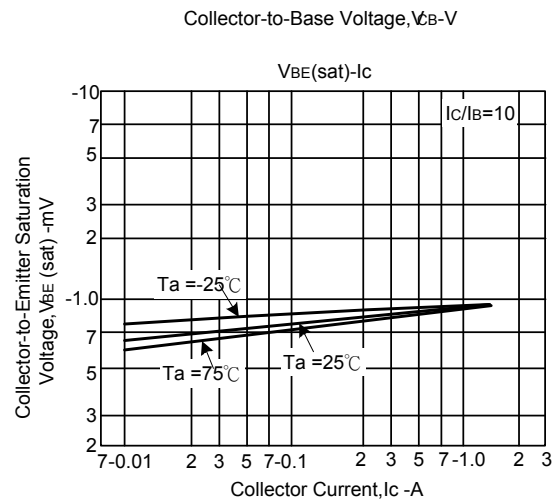
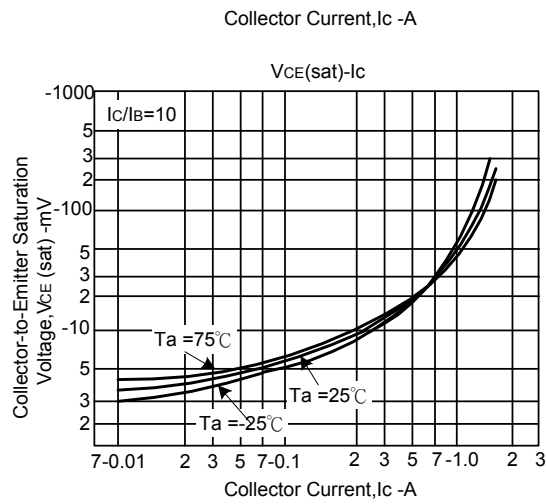

UTC assumes no responsibility for equipment failures that result from using products at values that exceed, even momentarily, rated values (such as maximum ratings, operating condition ranges, or other parameters) listed in products specifications of any and all UTC products described or contained herein. UTC products are not designed for use in life support appliances, devices or systems where malfunction of these products can be reasonably expected to result in personal injury. Reproduction in whole or in part is prohibited without the prior written consent of the copyright owner. UTC reserves the right to make changes to information published in this document, including without limitation specifications and product descriptions, at any time and without notice. This document supersedes and replaces all information supplied prior to the publication hereof.