

**Dual IGBT
 HVIGBT Module
 100 Amperes/3300 Volts**

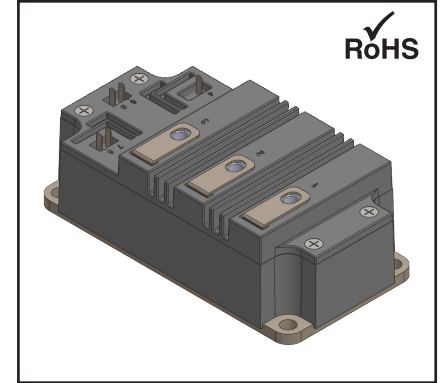
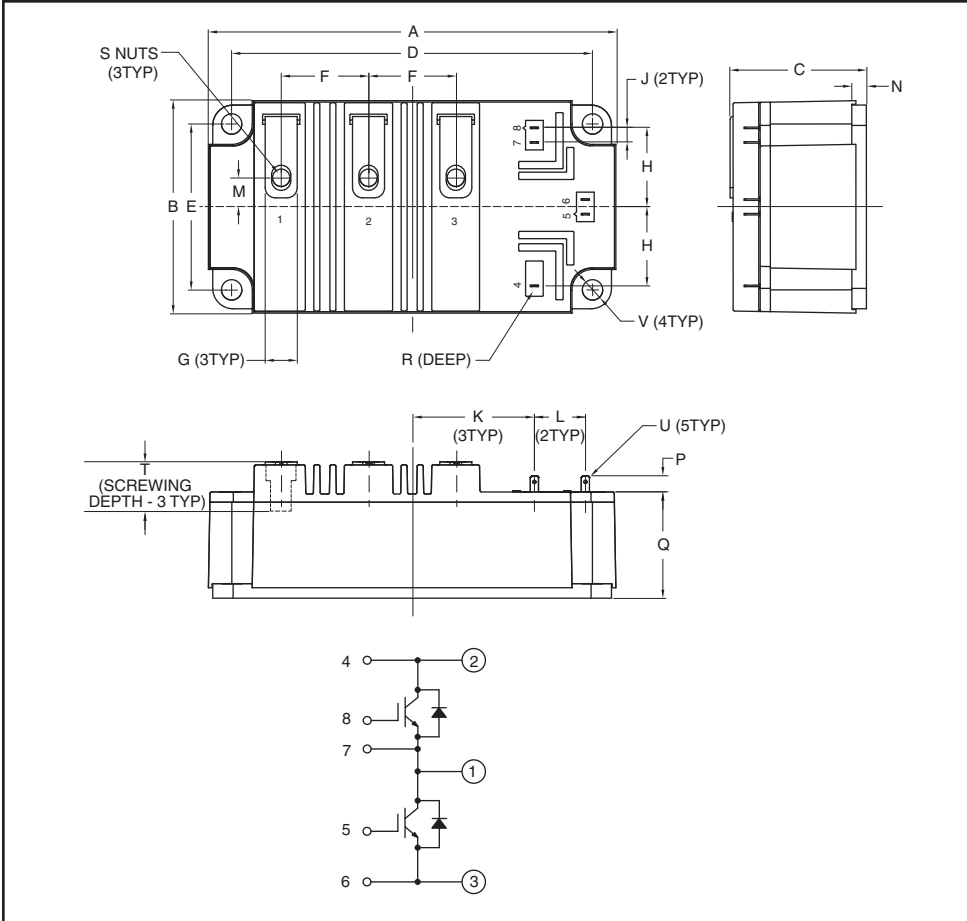

Description:

Powerex HVIGBTs feature highly insulating housings that offer enhanced protection by means of greater creepage and strike clearance distance for many demanding applications like medium voltage drives and auxiliary traction applications.

Features:

- 40 to 150°C Extended Temperature Range
- 100% Dynamic Tested
- 100% Partial Discharge Tested
- Advanced Mitsubishi R-Series Chip Technology
- Aluminum Nitride (AlN) Ceramic Substrate for Low Thermal Impedance
- Complementary Line-up in Expanding Current Ranges to Mitsubishi HVIGBT Power Modules
- Copper Baseplate
- Creepage and Clearance Meet IEC 60077-1
- Rugged SWSOA and RRSOA

Outline Drawing and Circuit Diagram

Dimensions	Inches	Millimeters
A	5.51	140.0
B	2.87	73.0
C	1.50	38.0
D	4.88±0.01	124.0±0.25
E	2.24±0.01	57.0±0.25
F	1.18	30.0
G	0.43	11.0
H	1.07	27.15
J	0.20	5.0
K	1.65	42.0

Dimensions	Inches	Millimeters
L	0.69±0.01	17.5±0.25
M	0.38	9.75
N	0.20	5.0
P	0.22	5.5
Q	1.04	26.5
R	0.16	4.0
S	M5 Metric	M5
T	0.63 Min.	16.0 Min.
U	0.11 x 0.02	2.8 x 0.5
V	0.28 Dia.	7.0 Dia.

Information presented is based upon manufacturers testing and projected capabilities. This information is subject to change without notice. The manufacturer makes no claim as to the suitability of use, reliability, capability, or future availability of this product.

QID3310006
Dual IGBT HVIGBT Module
 100 Amperes/3300 Volts

Absolute Maximum Ratings, $T_j = 25^\circ\text{C}$ unless otherwise specified

Ratings	Symbol	QID3310006	Units
Junction Temperature	T_j	-50 to +150	$^\circ\text{C}$
Operating Temperature	T_{op}	-50 to +150	$^\circ\text{C}$
Storage Temperature	T_{stg}	-55 to +150	$^\circ\text{C}$
Collector-Emitter Voltage ($V_{GE} = 0\text{V}$)	V_{CES}	3300	Volts
Gate-Emitter Voltage ($V_{CE} = 0\text{V}$)	V_{GES}	± 20	Volts
Collector Current ($T_C = 102^\circ\text{C}$)	I_C	100	Amperes
Collector Current ($T_C = 25^\circ\text{C}$)	I_C	185	Amperes
Peak Collector Current (Pulse)	I_{CM}	200*	Amperes
Diode Forward Current** ($T_C = 99^\circ\text{C}$)	I_F	100	Amperes
Diode Forward Surge Current** (Pulse)	I_{FM}	200*	Amperes
I^2t for Diode ($t = 10\text{ms}$, $V_R = 0\text{V}$, $T_j = 125^\circ\text{C}$)	I^2t	7.5	kA^2sec
Maximum Collector Dissipation ($T_C = 25^\circ\text{C}$, IGBT Part, $T_{j(max)} \leq 150^\circ\text{C}$)	P_C	1040	Watts
Mounting Torque, M5 Terminal Screws	—	35	in-lb
Mounting Torque, M6 Mounting Screws	—	44	in-lb
Module Weight (Typical)	—	800	Grams
Isolation Voltage (Charged Part to Baseplate, AC 60Hz 1 min.)	V_{iso}	6.0	kVolts
Partial Discharge ($V_1 = 3500 V_{RMS}$, $V_2 = 2600 V_{RMS}$, $f = 60\text{Hz}$ (Acc. to IEC 1287))	Q_{pd}	10	pC
Maximum Short-Circuit Pulse Width, ($V_{CC} \leq 2500\text{V}$, $V_{CE} \leq V_{CES}$, $V_{GE} = 15\text{V}$, $T_j = 125^\circ\text{C}$)	t_{psc}	10	μs

Electrical Characteristics, $T_j = 25^\circ\text{C}$ unless otherwise specified

Characteristics	Symbol	Test Conditions	Min.	Typ.	Max.	Units
Collector-Cutoff Current	I_{CES}	$V_{CE} = V_{CES}$, $V_{GE} = 0\text{V}$	—	—	1.0	mA
Gate Leakage Current	I_{GES}	$V_{GE} = V_{GES}$, $V_{CE} = 0\text{V}$	—	—	0.5	μA
Gate-Emitter Threshold Voltage	$V_{GE(th)}$	$I_C = 15\text{mA}$, $V_{CE} = 10\text{V}$	5.5	6.0	6.5	Volts
Collector-Emitter Saturation Voltage	$V_{CE(sat)}$	$I_C = 100\text{A}$, $V_{GE} = 15\text{V}$, $T_j = 25^\circ\text{C}$	—	2.7***	3.0	Volts
		$I_C = 100\text{A}$, $V_{GE} = 15\text{V}$, $T_j = 125^\circ\text{C}$	—	3.4	4.0	Volts
		$I_C = 100\text{A}$, $V_{GE} = 15\text{V}$, $T_j = 150^\circ\text{C}$	—	3.6	—	Volts
Total Gate Charge	Q_G	$V_{CC} = 1800\text{V}$, $I_C = 85\text{A}$, $V_{GE} = 15\text{V}$	—	0.9	—	μC
Emitter-Collector Voltage**	V_{EC}	$I_E = 100\text{A}$, $V_{GE} = 0\text{V}$, $T_j = 25^\circ\text{C}$	—	2.3	3.0	Volts
		$I_E = 100\text{A}$, $V_{GE} = 0\text{V}$, $T_j = 125^\circ\text{C}$	—	2.45	—	Volts
		$I_E = 100\text{A}$, $V_{GE} = 0\text{V}$, $T_j = 150^\circ\text{C}$	—	2.55	—	Volts

* Pulse width and repetition rate should be such that device junction temperature (T_j) does not exceed $T_{j(max)}$ rating.

** Represents characteristics of the anti-parallel, emitter-to-collector free-wheel diode (FWDi).

*** Pulse width and repetition rate should be such that device junction temperature rise is negligible.

QID3310006
Dual IGBT HVIGBT Module
 100 Amperes/3300 Volts

Electrical Characteristics, $T_j = 25\text{ }^\circ\text{C}$ unless otherwise specified

Characteristics	Symbol	Test Conditions	Min.	Typ.	Max.	Units
Input Capacitance	C_{ies}		—	11.5	—	nF
Output Capacitance	C_{oes}	$V_{GE} = 0V, V_{CE} = 10V$	—	0.75	—	nF
Reverse Transfer Capacitance	C_{res}		—	0.35	—	nF
Turn-on Delay Time	$t_{d(on)}$	$V_{CC} = 1800V, I_C = 100A,$	—	800	—	ns
Rise Time	t_r	$V_{GE} = \pm 15V,$	—	160	—	ns
Turn-off Delay Time	$t_{d(off)}$	$R_{G(on)} = 30\Omega, R_{G(off)} = 100\Omega,$	—	3200	—	ns
Fall Time	t_f	$L_S = 100nH, \text{ Inductive Load}$	—	1300	—	ns
Turn-on Switching Energy	E_{on}	$T_j = 150^\circ\text{C}, I_C = 100A, V_{GE} = \pm 15V,$	—	250	—	mJ/P
Turn-off Switching Energy	E_{off}	$R_{G(on)} = 30\Omega, R_{G(off)} = 100\Omega,$ $V_{CC} = 1800V, L_S = 100nH, \text{ Inductive Load}$	—	180	—	mJ/P
Diode Reverse Recovery Time**	t_{rr}	$V_{CC} = 1800V, I_E = 100A,$	—	500	—	ns
Diode Reverse Recovery Charge**	Q_{rr}	$V_{GE} = \pm 15V, R_{G(on)} = 30\Omega,$	—	90*	—	μC
Diode Reverse Recovery Energy	E_{rec}	$L_S = 100nH, \text{ Inductive Load}, T_j = 150^\circ\text{C}$	—	133	—	mJ/P
Stray Inductance (C1-E2)	L_{SCE}		—	75	—	nH
Lead Resistance Terminal-Chip	R_{CE}		—	1.5	—	$m\Omega$

Thermal and Mechanical Characteristics, $T_j = 25\text{ }^\circ\text{C}$ unless otherwise specified

Characteristics	Symbol	Test Conditions	Min.	Typ.	Max.	Units
Thermal Resistance, Junction to Case***	$R_{th(j-c)} Q$	Per IGBT	—	0.12	—	$^\circ\text{C/W}$
Thermal Resistance, Junction to Case***	$R_{th(j-c)} D$	Per FWDi	—	0.19	—	$^\circ\text{C/W}$
Contact Thermal Resistance, Case to Fin	$R_{th(c-f)}$	Per Module, Thermal Grease Applied, $\lambda_{grease} = 1W/mK$	—	0.018	—	$^\circ\text{C/W}$
Comparative Tracking Index	CTI		600	—	—	
Clearance Distance in Air (Terminal to Base)	$d_{a(t-b)}$		35.0	—	—	mm
Creepage Distance Along Surface (Terminal to Base)	$d_{s(t-b)}$		64	—	—	mm
Clearance Distance in Air (Terminal to Terminal)	$d_{a(t-t)}$		19	—	—	mm
Creepage Distance Along Surface (Terminal to Terminal)	$d_{s(t-t)}$		54	—	—	mm

*Pulse width and repetition rate should be such that device junction temperature rise is negligible.

**Represents characteristics of the anti-parallel, emitter-to-collector free-wheel diode (FWDi).

*** T_c measurement point is just under the chips.

QID3310006
Dual IGBT HVIGBT Module
 100 Amperes/3300 Volts

OUTPUT CHARACTERISTICS (TYPICAL)

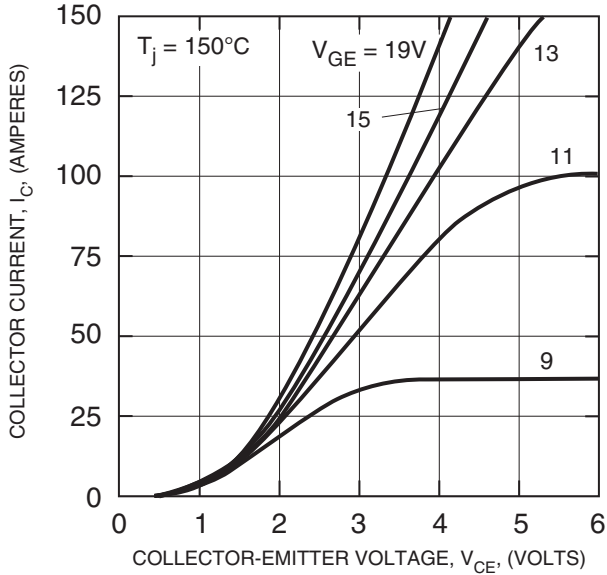

COLLECTOR-EMITTER SATURATION VOLTAGE CHARACTERISTICS (TYPICAL)

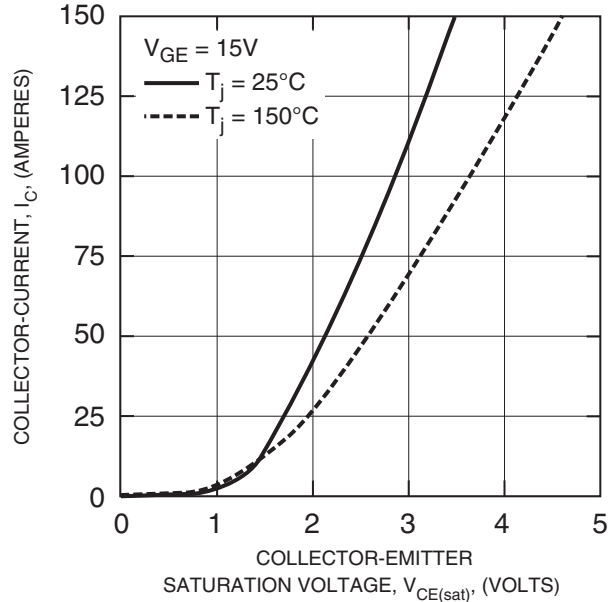

TRANSFER CHARACTERISTICS (TYPICAL)

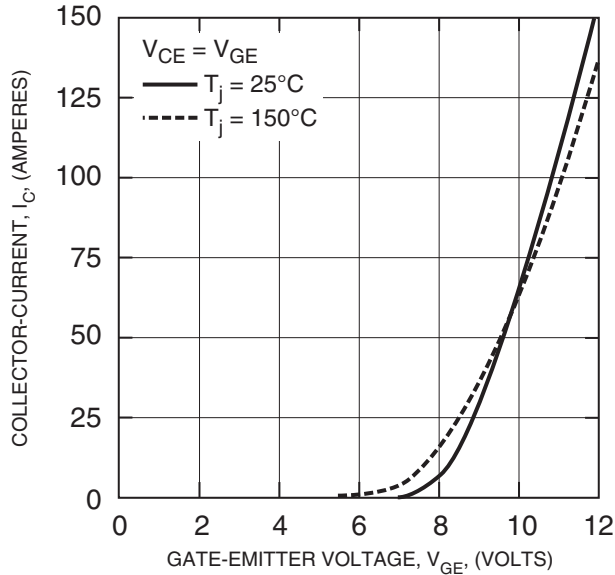

FREE-WHEEL DIODE FORWARD CHARACTERISTICS (TYPICAL)

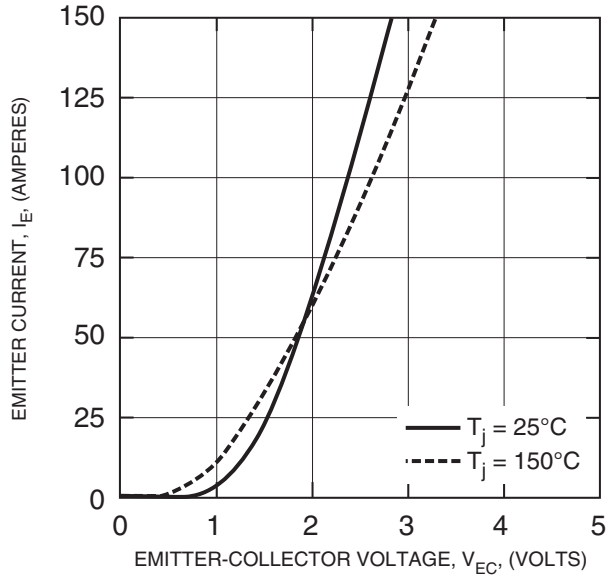

Information presented is based upon manufacturers testing and projected capabilities. This information is subject to change without notice. The manufacturer makes no claim as to the suitability of use, reliability, capability, or future availability of this product.

QID3310006
Dual IGBT HVIGBT Module
 100 Amperes/3300 Volts

CAPACITANCE VS. V_{CE}
 (TYPICAL)

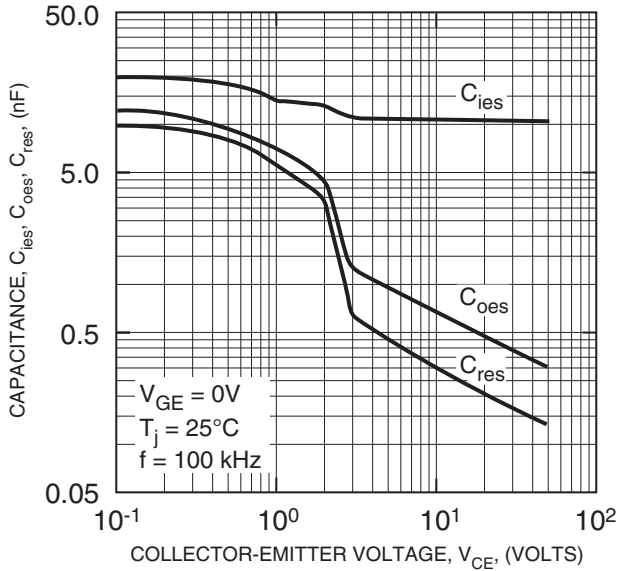

GATE CHARGE VS. V_{GE}

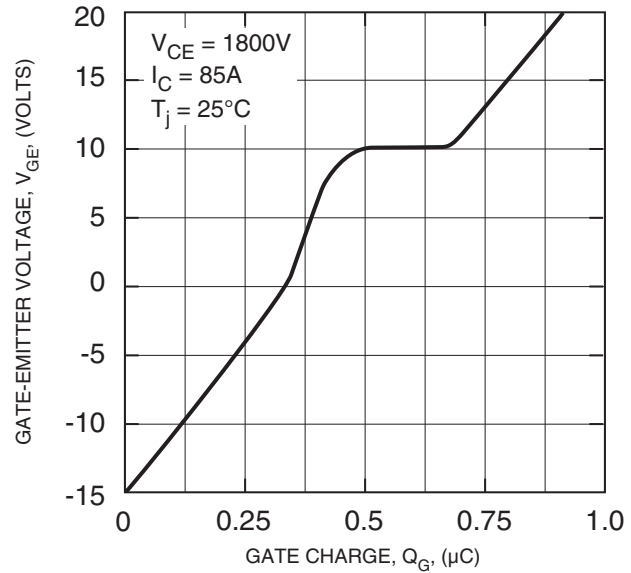

SWITCHING ENERGY CHARACTERISTICS (TYPICAL)

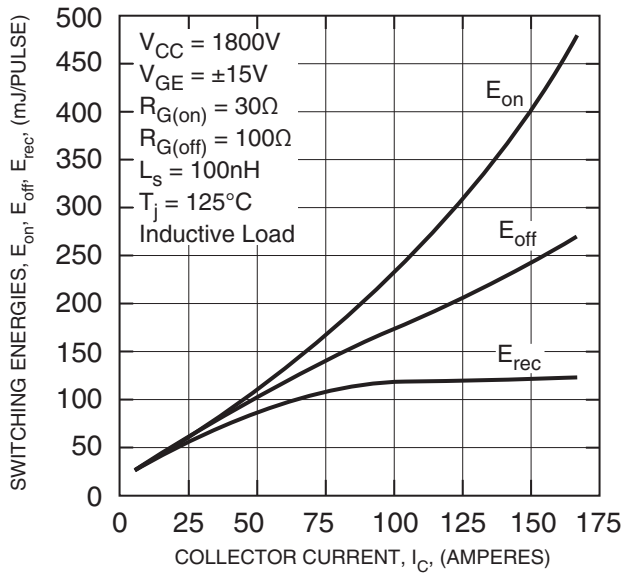

HALF-BRIDGE SWITCHING ENERGY CHARACTERISTICS (TYPICAL)

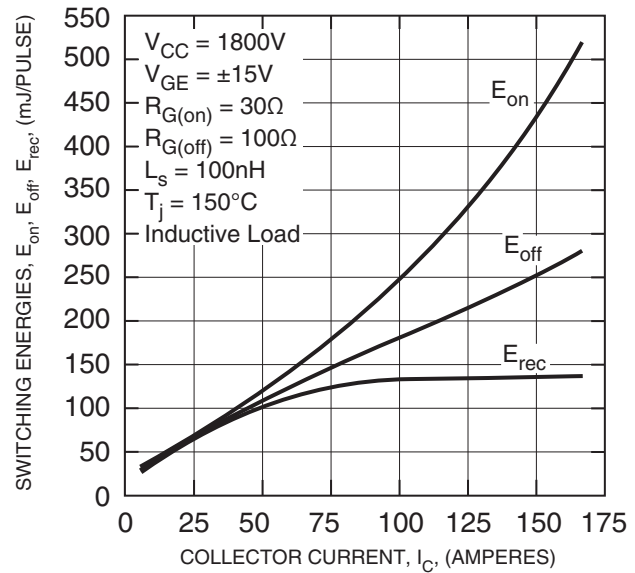

QID3310006
Dual IGBT HVIGBT Module
 100 Amperes/3300 Volts

REVERSE BIAS SAFE OPERATING AREA (TYPICAL)

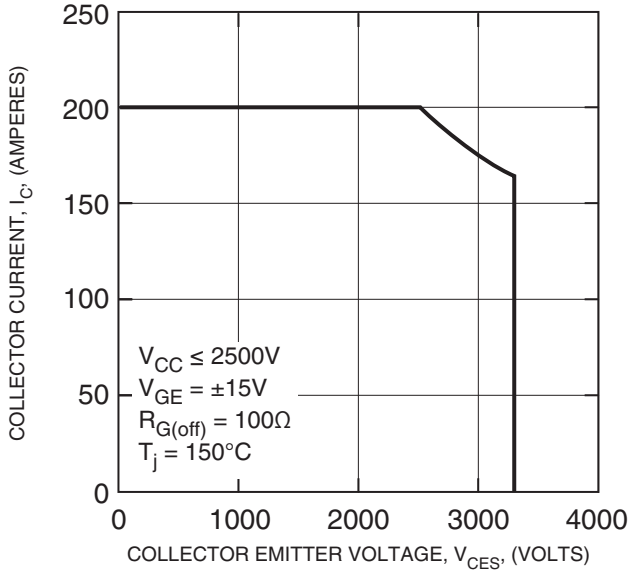

FREE-WHEEL DIODE REVERSE RECOVERY SAFE OPERATING AREA (TYPICAL)

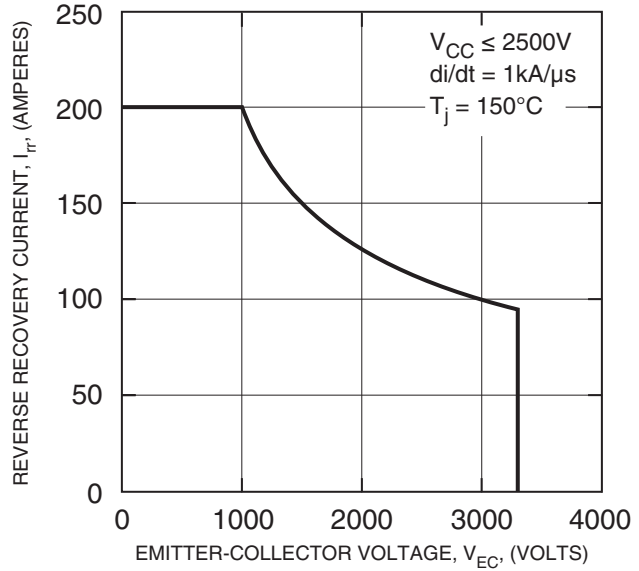

TRANSIENT THERMAL IMPEDANCE CHARACTERISTICS (IGBT & FWDi)

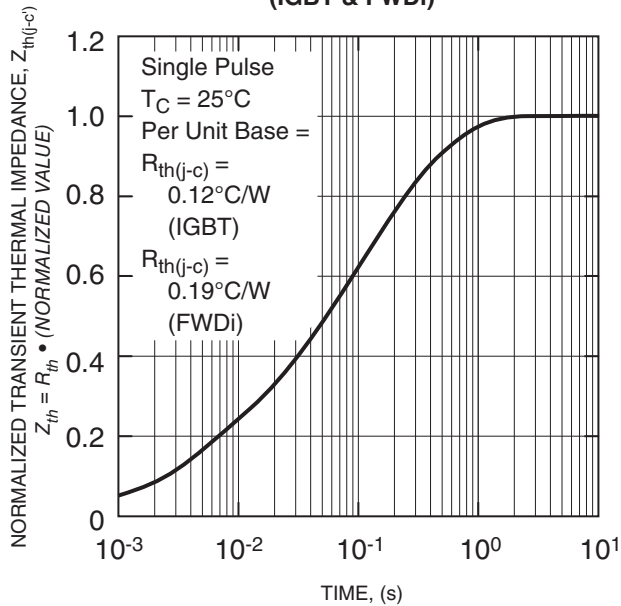

Information presented is based upon manufacturers testing and projected capabilities. This information is subject to change without notice. The manufacturer makes no claim as to the suitability of use, reliability, capability, or future availability of this product.