



## PZTA94

PNP SILICON TRANSISTOR

### HIGH VOLTAGE TRANSISTOR

#### FEATURES

- \* Collector-Emitter voltage:  
 $V_{CE0} = -400V$
- \* Collector Dissipation:  
 $P_{D(MAX)} = 625mW$
- \* Low collector-Emitter saturation voltage

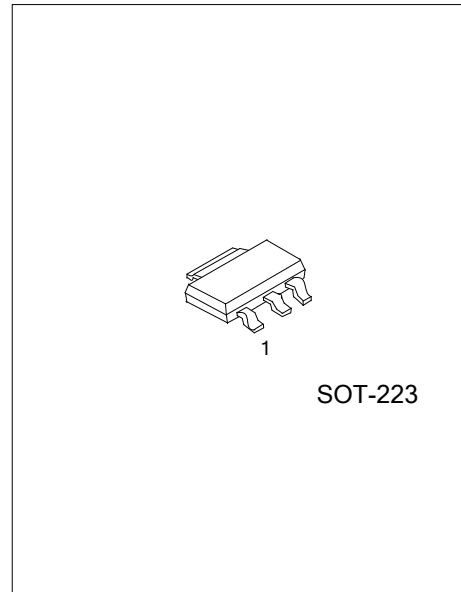

SOT-223

#### ORDERING INFORMATION

Ordering Number		Package	Pin Assignment			Packing
Lead Free	Halogen Free		1	2	3	
PZTA94L-AA3-R	PZTA94G-AA3-R	SOT-223	B	C	E	Tape Reel

Note: Pin Assignment: E: Emitter C: Case B: Base

<p>PZTA94G-AA3-R</p> <ul style="list-style-type: none"> <li>(1) Packing Type</li> <li>(2) Package Type</li> <li>(3) Green Package</li> </ul>	<ul style="list-style-type: none"> <li>(1) R: Tape Reel</li> <li>(2) AA3: SOT-223</li> <li>(3) G: Halogen Free and Lead Free, L: Lead Free</li> </ul>
--	---

#### MARKING

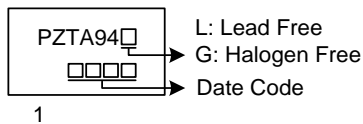

1

■ **ABSOLUTE MAXIMUM RATING** (Operating temperature range applies unless otherwise specified)

PARAMETER	SYMBOL	RATINGS	UNIT
Collector-Base Voltage	$V_{CBO}$	-400	V
Collector-Emitter Voltage	$V_{CEO}$	-400	V
Emitter-Base Voltage	$V_{EBO}$	-6	V
Collector Power Dissipation ( $T_A=25^\circ\text{C}$ )	$P_D$	625	mW
Collector Current	$I_C$	-300	mA
Junction Temperature	$T_J$	+150	$^\circ\text{C}$
Storage Temperature	$T_{STG}$	-40 ~ +150	$^\circ\text{C}$

Note: Absolute maximum ratings are those values beyond which the device could be permanently damaged. Absolute maximum ratings are stress ratings only and functional device operation is not implied.

■ **ELECTRICAL CHARACTERISTICS** ( $T_J=25^\circ\text{C}$ , unless otherwise specified)

PARAMETER	SYMBOL	TEST CONDITIONS	MIN	TYP	MAX	UNIT
Collector-Base Breakdown Voltage	$BV_{CBO}$	$I_C=-100\mu\text{A}, I_E=0$	-400			V
Collector-Emitter Breakdown Voltage	$BV_{CEO}$	$I_C=-1\text{mA}, I_B=0$	-400			V
Collector-Emitter Breakdown Voltage	$BV_{CES}$	$I_C=-100\mu\text{A}, V_{BE}=0$	-400			V
Emitter-Base Breakdown Voltage	$BV_{EBO}$	$I_E=-100\mu\text{A}, I_C=0$	-5			V
Collector Cut-off Current	$I_{CBO}$	$V_{CB}=-300\text{V}, I_E=0$			-100	nA
Collector Cut-off Current	$I_{CES}$	$V_{CE}=-400\text{V}, V_{BE}=0$			-1	$\mu\text{A}$
Emitter Cut-off Current	$I_{EBO}$	$V_{EB}=-4\text{V}, I_C=0$			100	nA
DC Current Gain(note)	$h_{FE}$	$V_{CE}=-10\text{V}, I_C=-1\text{mA}$	60		300	
		$V_{CE}=-10\text{V}, I_C=-10\text{mA}$	70			
		$V_{CE}=-10\text{V}, I_C=-50\text{mA}$	70			
		$V_{CE}=-10\text{V}, I_C=-100\text{mA}$	40			
Collector-Emitter Saturation Voltage	$V_{CE(SAT)}$	$I_C=-10\text{mA}, I_B=-1\text{mA}$ $I_C=-50\text{mA}, I_B=-5\text{mA}$			-0.20 -0.5	V
Base-Emitter Saturation Voltage	$V_{BE(SAT)}$	$I_C=-10\text{mA}, I_B=-1\text{mA}$			-0.75	V
Output Capacitance	$C_{ob}$	$V_{CB}=-20\text{V}, I_E=0, f=1\text{MHz}$			7	pF

Note: Pulse test: Pulse Width<300 $\mu\text{s}$ , Duty Cycle<2%.

## ■ TYPICAL CHARACTERISTICS

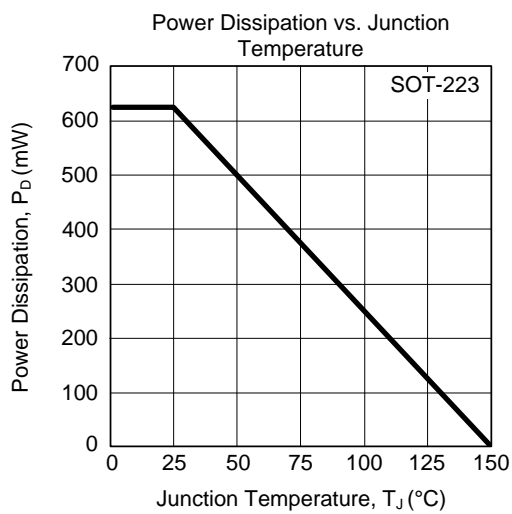
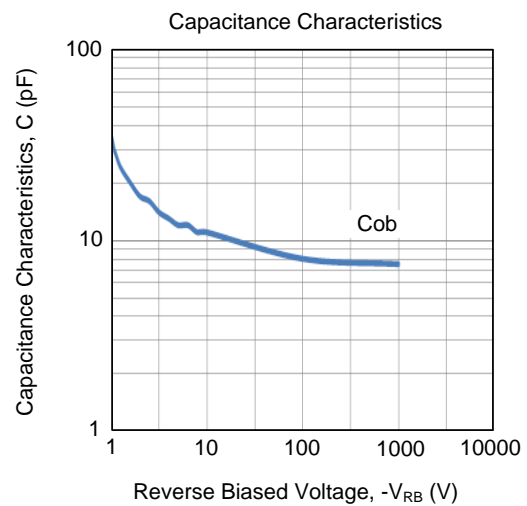
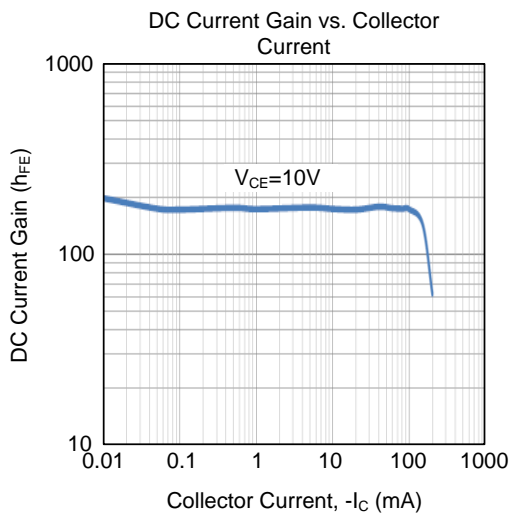
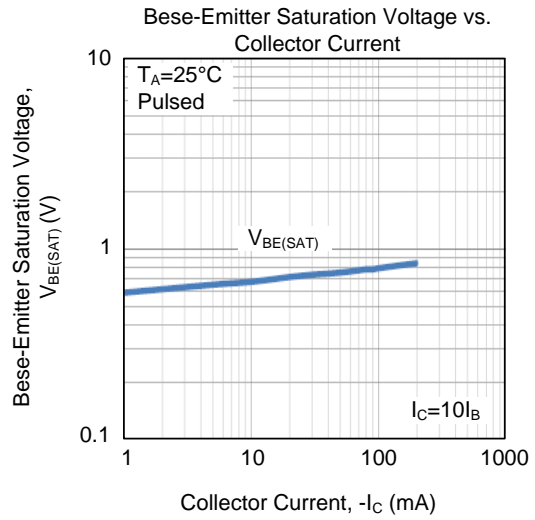
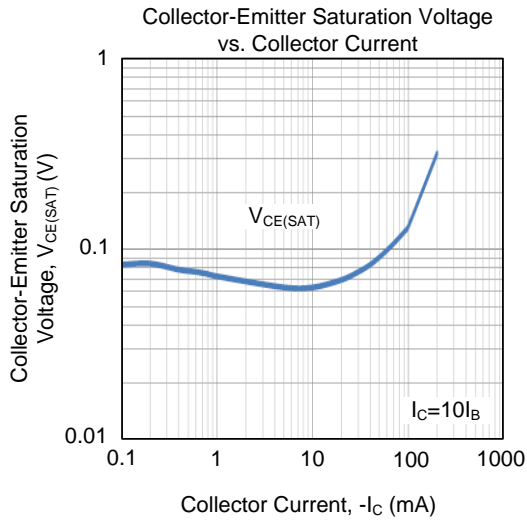

UTC assumes no responsibility for equipment failures that result from using products at values that exceed, even momentarily, rated values (such as maximum ratings, operating condition ranges, or other parameters) listed in products specifications of any and all UTC products described or contained herein. UTC products are not designed for use in life support appliances, devices or systems where malfunction of these products can be reasonably expected to result in personal injury. Reproduction in whole or in part is prohibited without the prior written consent of the copyright owner. UTC reserves the right to make changes to information published in this document, including without limitation specifications and product descriptions, at any time and without notice. This document supersedes and replaces all information supplied prior to the publication hereof.