



Specifications for
TFT-LCD Monitor
(5.7" VGA 640 x RGB x 480 Landscape)

Version 4.0

(Please be sure to check the specifications latest version.)

MODEL COM57T5N07RSS

Customer's Approval

Signature:

Name:

Section:

Title:

Date:

ORTUSTECH

TOPPAN INC.
Electronics Division
Ortus Subdivision

Approved by

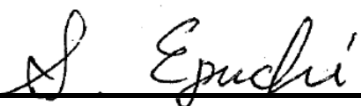





Checked by



Prepared by



Version History

Ver.	Date	Page	Description	
0.0	Jul.19,2019	-	-	Tentative issue
1.0	Jun.10,2020	-	-	First issue
		-	-	Completely revised
2.0  ×7	Nov.6,2020	P.9 P.10 P.18 P.22 P.28	Delete Correct Correct Correct Add Correct Correct	7. Recommended Operating Conditions Condition (Input voltage for logic) 8.1.2 Backlight Condition (Forward voltage / Estimated Life of LED) 11.1 Optical Characteristics Comment (Backlight) Center brightness 11.2 Temperature Characteristics Comment (Backlight) 14. Reliability Test Packing test Reliability Criteria Error correct (Contrast ratio) APPENDIX (1. Measurement Condition) Comment (Backlight)
3.0  ×7	Jan.13,2021	P.1 P.4 P.7 P.10 P.12 P.18 P.29	Change Add Change Delete Correct Correct Correct	Cover Model name 1. Application RoHS(2.0) directive 4. LCD Datacode Display Items 8.1.1 Display Module Error delete 8.2 AC Characteristics (Switching Waveform Characteristics) Error correct 11.1 Optical Characteristics [Data] APPENDIX (2. Test Method) [Data]
4.0  ×9	Nov.12,2021	All P.7 P.8 P.13 P.14 P.15 P.22 P.23 P.26	Change Change Add Add Add Add Delete Correct Correct	Company name notation TOPPAN PRINTING CO.,LTD. → TOPPAN INC. TOPPAN PRINTING → TOPPAN 4. LCD Datacode Error correct 5. Pin Assignment DE mode function 8.3 Input Timing Characteristics DE mode function 8.4 Driving Timing Chart DE mode function 8.5 Example of Driving Timing Chart DE mode function 14. Reliability Test Error delete 15. Packing Specifications Packing Specifications 16.4 Storage Condition for Shipping Cartons Maximum piling up

Contents

1. Application	4
2. Outline Specifications		
2.1 Features of the Product	5
2.2 Display Method	5
3. Dimensions and Shape		
3.1 Dimensions	5
3.2 Outward Form	6
4. LCD Datacode	7
5. Pin Assignment	8
6. Absolute Maximum Rating	9
7. Recommended Operating Conditions	9
8. Electrical Characteristics		
8.1 DC Characteristics		
8.1.1 Display Module	10
8.1.2 Backlight	10
8.2 AC Characteristics	11
8.3 Input Timing Characteristics	13
8.4 Driving Timing Chart	14
8.5 Example of Driving Timing Chart	15
9. Description of Sequence		
9.1 Power ON Sequence	16
9.2 Power OFF Sequence	16
10. LED Circuit	17
11. Characteristics		
11.1 Optical Characteristics	18
11.2 Temperature Characteristics	18
12. Inspection Criteria		
12.1 Inspection Condition	19
12.2 Light Method	19
12.3 Definition Of Inspection Area	19
13. Item and Criteria		
13.1 Visual inspection criterion in cosmetic	20
13.2 Defective Display and Screen Quality	21
14. Reliability Test	22
15. Packing Specifications	23
16. Handling Instruction		
16.1 Cautions for Handling LCD panels	24
16.2 Precautions for Handling	25
16.3 Precautions for Operation	25
16.4 Storage Condition for Shipping Cartons	26
16.5 Precautions for Peeling off the Protective film	27
16.6 Warranty	27
APPENDIX	28

1. Application

This Specification is applicable to 144mm (5.7 inch) TFT-LCD monitor for non-military use.

- ◎ TOPPAN makes no warranty or assume no liability that use of this Product and/or any information including drawings in this Specification by Purchaser is not infringing any patent or other intellectual property rights owned by third parties, and TOPPAN shall not grant to Purchaser any right to use any patent or other intellectual property rights owned by third parties. Since this Specification contains TOPPAN's confidential information and copy right, Purchaser shall use them with high degree of care to prevent any unauthorized use, disclosure, duplication, publication or dissemination of TOPPAN's confidential information and copy right.
- ◎ If Purchaser intends to use this Products for an application which requires higher level of reliability and/or safety in functionality and/or accuracy such as transport equipment (aircraft, train, automobile, etc.), disaster-prevention/security equipment or various safety equipment, Purchaser shall consult TOPPAN on such use in advance.
- ◎ This Product shall not be used for application which requires extremely higher level of reliability and/or safety such as aerospace equipment, telecommunication equipment for trunk lines, control equipment for nuclear facilities or life-support medical equipment.
- ◎ It must be noted as an mechanical design manner, especial attention in housing design to prevent actuation/flexure or caused by stress to the LCD module shall be considered.
- ◎ TOPPAN assumes no liability for any damage resulting from misuse, abuse, and/or miss-operation of the Product deviating from the operating conditions and precautions described in the Specification.
- ◎ TOPPAN is not responsible for any nonconformities and defects that are not specified in this specifications.
- ◎ If any issue arises as to information provided in this Specification or any other information, TOPPAN and Purchaser shall discuss them in good faith and seek solution.
- ◎ TOPPAN assumes no liability for defects such as electrostatic discharge failure occurred during peeling off the protective film or Purchaser's assembly process.
- ◎ This Product is compatible for RoHS(2.0) directive.

Object substance	Maximum content [ppm]
Cadmium and its compound	100
Hexavalent Chromium Compound	1000
Lead & Lead compound	1000
Mercury & Mercury compound	1000
Polybrominated biphenyl series(PBB series)	1000
Polybrominated biphenyl ether series(PBDE series)	1000
Bis(2-ethylhexyl)phthalate series(DEHP series)	1000
Butyl benzyl phthalate series(BBP series)	1000
Dibutyl phthalate series(DBP series)	1000
Diisobutyl phthalate series(DIBP series)	1000

2. Outline Specifications

2.1 Features of the Product

- 5.7 inch diagonal display, 1,920 [H] x 480 [V] dots.
- 6-bit 262,144 color display capability.
- Power supply operation of 3.3V(MODULE) + BACKLIGHT POWER.
- Built in Timing generator (TG), Counter-electrode driving circuitry and power supply circuit.
- High bright white LED back-light.
- Pb FREE mount technology use.(fix RoHS Phase 3)

2.2 Display Method

Items	Specifications	Remarks
Display type	FFS type 262,144 colors. Transmission type, Normally black.	
Driving method	a-Si TFT Active matrix. Line-scanning, Non-interlace.	
Dot arrangement	RGB stripe arrangement.	Refer to "Dot arrangement".
Signal input method	6-bit RGB, parallel input.	
Backlight type	High bright white LED.	

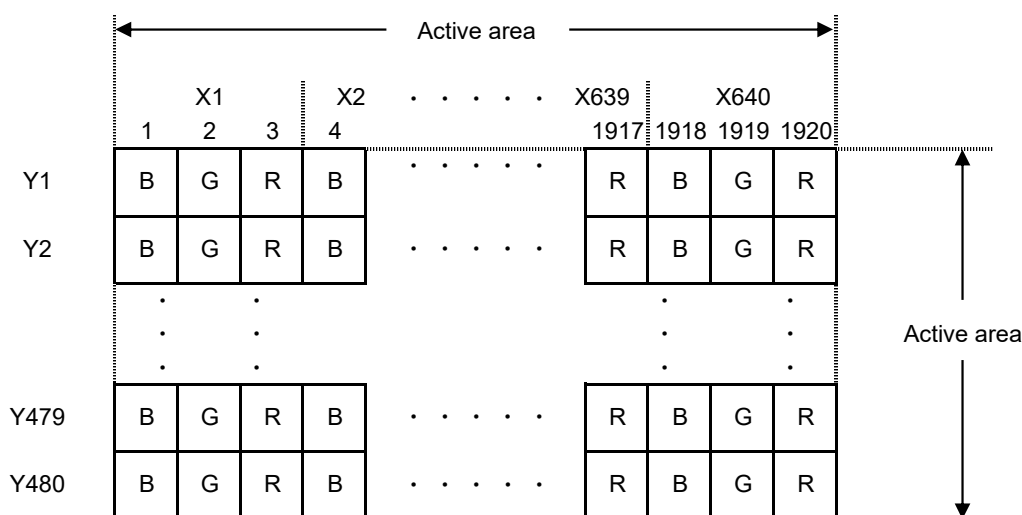

Dot arrangement (FPC insertion placed left)

3. Dimensions and Shape

3.1 Dimensions

Items	Specifications	Unit	Remarks
Outline dimensions	127.20[H] × 100.40[V] × 5.70[D]	mm	Exclude FPC cable.
Active area	115.20[H] × 86.40[V]	mm	144.0mm diagonal.
Number of dots	1,920[H] × 480[V]	dot	
Dot pitch	60.00[H] × 180.00[V]	μm	
Surface hardness of the polarizer	3	H	Load:2.0N / Surface finishing: Clear
Weight	101.7	g	

3.2 Outward Form

EC No.	REV. No.	REVISE	DATE (Y-M-D)	APPROVED	CHECKED	PREPARED
--------	----------	--------	--------------	----------	---------	----------

(6/29)
19TLM024
Issue: Nov.12,2021

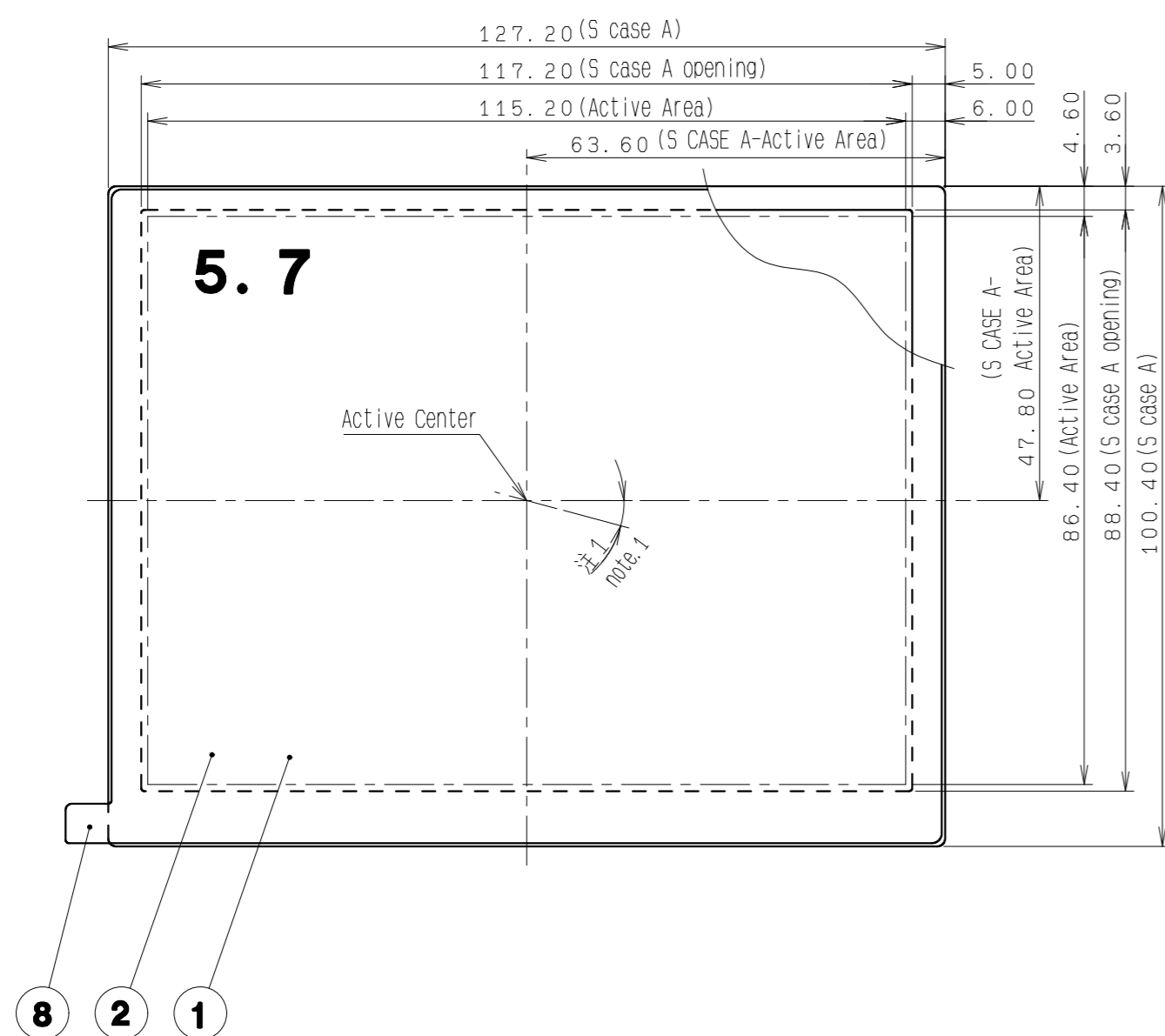

3.74±0.3
(0.45)
(S CASE A-Pol)

3

5.70±0.3
11.00MAX
Hight of FPC A frosting
FPC Aの凝結

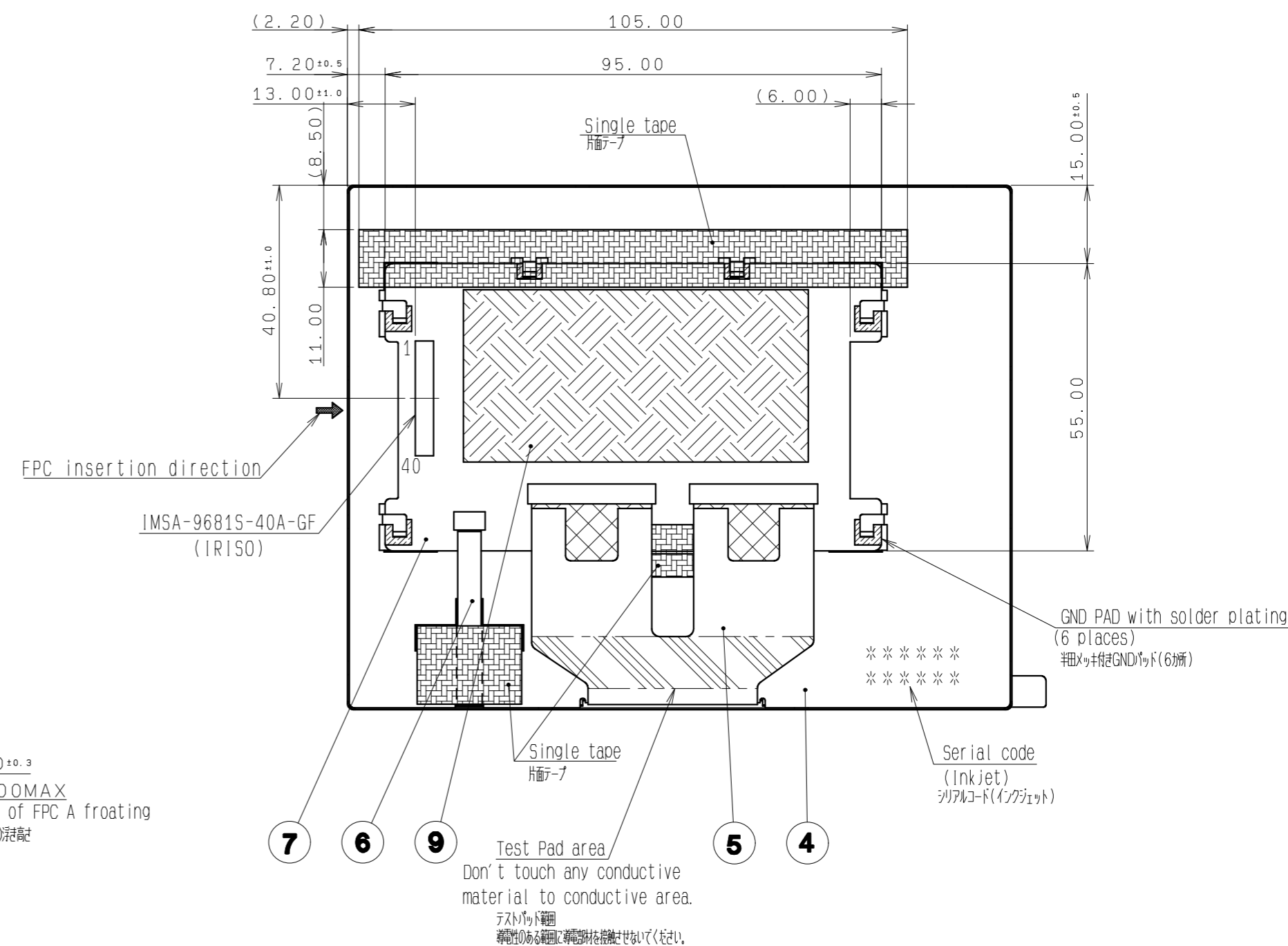

Test Pad area
Don't touch any conductive material to conductive area.
テストパッド範囲
導電性のある範囲に導電部を接触させてはいけません。

Angular deviation of LCD cell from the TFT-LCD monitor's reference note axis shall be less than $\pm 50'$.
注1. TFT-LCD PANELの角度スレは、モニター基準軸に対し $\pm 50'$ 以下とする。
Burr's direction of S CASE is outward. (Burr's size is less than 0.03mm.)
2. S CASEのバリ方向は外側になります。(MAXO. 03mm)

Insulation Tape	9		
Protection Film	8		
PCB A	7		
FPC B	6		Use of LED
FPC A	5		Use of LCD
S CASE C	4		SUS(t=0.3)
S CASE A	3		SUS(t=0.3)
Polarizer	2		
TFT-LCD PANEL	1	Glass substrate thickness=0.5t±0.5t	
PART NAME	ITEM	MATERIAL GRADE	REMARK

APPROVED 尾木	GENERAL TOLERANCE ±0.5	SCALE 1/1	UNIT mm	<p>TOPPAN INC. DO NOT DUPLICATE, CONFIDENTIAL AND PROPRIETARY</p>
CHECKED 加藤	ISSUE (Y-M-D) 20:04:21	MODEL COM57T5N07R**		
CHECKED	NAME			
DESIGN 増田剛				
DRAW 増田剛		OUTLINE-G5N07		DRAWING No. RJD529981D201 REV. SHEET DIV.



4. LCD Datacode

1) Display Items

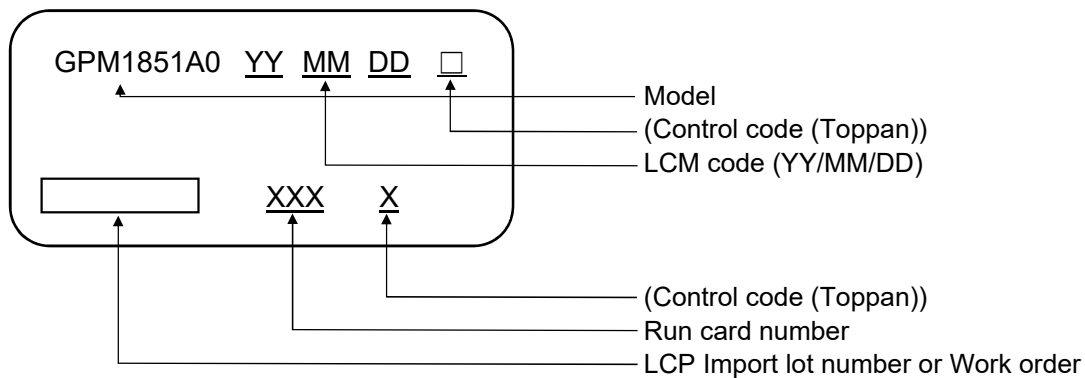

2) Location of LCD Datacode

Refer to 3.2 "Outward Form".

3) Others

Please note that it is likely to disappear with an organic solvent about the LCD Datacode.



5. Pin Assignment

No.	Symbol	Function
1	GND	GND.
2	CK	System clock input.(Falling edge use)
3	HSYNC	Horizontal sync signal input.(negative polarity) If use DE mode,connect to VDD.
4	VSYNC	Vertical sync signal input.(negative polarity) If use DE mode,connect to VDD.
5	GND	GND.
6	R0	Display data(R). 00h: Black R0:LSB R5:MSB Driver has internal gamma conversion.
7	R1	
8	R2	
9	R3	
10	R4	
11	R5	
12	GND	GND.
13	G0	Display data(G). 00h: Black G0:LSB G5:MSB Driver has internal gamma conversion.
14	G1	
15	G2	
16	G3	
17	G4	
18	G5	
19	GND	GND.
20	B0	Display data(B). 00h: Black B0:LSB B5:MSB Driver has internal gamma conversion.
21	B1	
22	B2	
23	B3	
24	B4	
25	B5	
26	GND(TEST)	TEST (Connect to GND)
27	ENAB	Input data effective signal. (Hi: active)
28	VDD	Power supply input.
29	VDD	Power supply input.
30	R/L	Right / Left switching terminal (Low : Normally)
31	U/D	Up / Down switching terminal (High: Normally)
32	NC	No connect.
33	CA1	Backlight cathode power 1.
34	CA2	Backlight cathode power 2.
35	CA3	Backlight cathode power 3.
36	CA4	No connect.
37	AN1	Backlight anode power 1.
38	AN2	Backlight anode power 2.
39	AN3	Backlight anode power 3.
40	AN4	No connect.

- Used connector: IRISO [IMSA-9681S-40A-GF]
- Please make sure to check a consistency between pin assignment in "3.2 Outward Form" and your connector pin assignment when designing your circuit.
Inconsistency in input signal assignment may cause a malfunction.
- Since FFC connector has gold plated terminals, gilt finish contact shoe connector is recommended.
note: under situation is normal display.

(R/L=L, U/D=H)

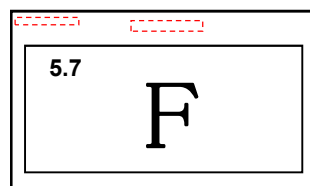

6. Absolute Maximum Rating

GND=0V

Item	Symbol	Condition	Rating		Unit	Applicable terminal
			MIN	MAX		
Supply voltage	VDD	Ta=25°C	-0.3	3.96	V	VDD
Input voltage for logic	VI		-0.3	VDD+0.3	V	CK, VSYNC, HSYNC, ENAB, R[5:0], G[5:0], B[5:0], R/L, U/D
LED direction current of order	IL	Ta=25°C	--	35	mA	CA[3:1], AN[3:1]
		Ta=70°C	--	15		
Storage temperature range	Tstg		-30	80	°C	
Storage humidity range	Hstg	Non condensing in an environmental moisture at or less than 40°C90%RH.				

Absolute maximum ratings is parametric values, should never be exceed any value at any moment.

Beyond which, it could be suffered from changes in characteristics and never be restored.

Moreover, it could even be suffered from permanent destruction.

Therefore, please note enough the fluctuation of input voltage, the characteristics of connected parts, I/O signal line serge, and ambient temperature, on designing the circuit.

7. Recommended Operating Conditions

GND=0V

Item	Symbol	Condition	Rating			Unit	Applicable terminal
			MIN	TYP	MAX		
Supply voltage	VDD		3.2	3.3	3.4	V	VDD
Input voltage for logic	VI		0	--	VDD	V	CK, VSYNC, HSYNC, ENAB, R[5:0], G[5:0], B[5:0], R/L, U/D
Operating temperature range	Top	Note 1,2	-20	25	70	°C	Panel surface temperature
Operating humidity range	Hop	Ta ≤ 30°C	20	--	80	%	
		Ta > 30°C	Non condensing in an environmental moisture at or less than 30°C80%RH.				

Note1: The temperature within the display will increase due to the heat radiated from the back light while in operation.

Necessary measures have to be taken in the product design to make sure that the display has proper ventilation so that temperature on any surface of this display should not exceed 70°C.

Note2: This monitor is operatable in this temperature range. With regard to optical characteristics, refer to Item ". 11.CHARACTERISTICS".

Note3: Acceptable Forward Current to LED is up to 15mA, when Ta=+70°C.

Do not exceed Allowable Forward Current shown on the chart below.

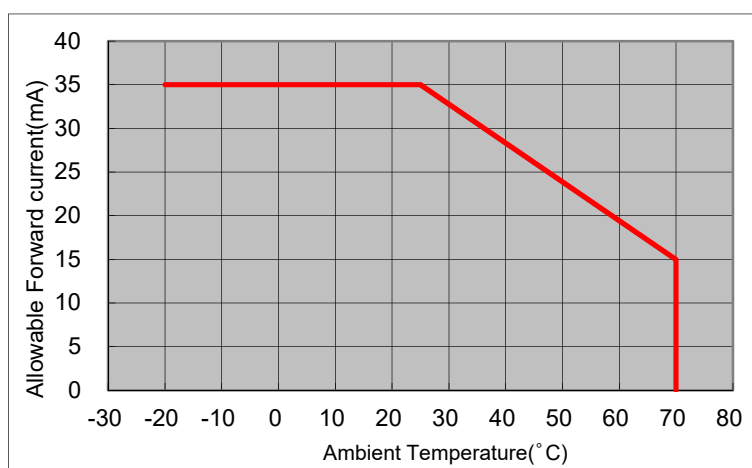

8. Electrical Characteristics

8.1 DC Characteristics

8.1.1 Display Module

(Unless otherwise noted, Ta=25°C, VDD=3.3V, GND=0V)

Item	Symbol	Condition	Rating			Unit	Applicable terminal
			MIN	TYP	MAX		
Input voltage for logic	VIH		0.7×VDD	--	VDD	V	CK, VSYNC, HSYNC, ENAB, R[5:0], G[5:0], B[5:0], R/L, U/D
	VIL		0	--	0.3×VDD	V	
Current consumption	IDD	fCLK=22.2MHz Color bar display	--	60	120	mA	VDD

8.1.2 Backlight

Item	Symbol	Condition	Rating			Unit	Applicable terminal
			MIN	TYP	MAX		
Forward current	IL25	Ta=25°C	--	15	35.0	mA	CA[3:1], AN[3:1]
	IL70	Ta=70°C	--	--	15.0	mA	
Forward voltage	VL	Ta=25°C, IL=15.0mA	12.5	14.0	15.3	V	
Estimated Life of LED	LL	Ta=25°C, IL=15.0mA Note	--	50,000	--	hrs	

- Note: - The lifetime of the LED is defined as a period till the brightness of the LED decreases to the half of its initial value.
- This figure is given as a reference purpose only, and not as a guarantee.
 - This figure is estimated for an LED operating alone.
- As the performance of an LED may differ when assembled as a monitor together with a TFT panel due to different environmental temperature.
- Estimated lifetime could vary on a different temperature and usually higher temperature could reduce the life significantly.

8.2 AC Characteristics

(Unless otherwise noted, Ta=25°C, VDD=3.3V, GND=0V)

Item	Symbol	Condition	Rating			Unit	Applicable terminal
			MIN	TYP	MAX		
CLK frequency	fCLK		20.5	22.2	25.4	MHz	CK
CLK Low period	tw1L	0.3×VDD or less.	6	--	-	ns	
CLK High period	tw1H	0.7×VDD or more.	6	--	-	ns	
Setup time	tsp		5	--	--	ns	CK, VSYNC, HSYNC, ENAB, R[5:0], G[5:0], B[5:0], R/L, U/D
Hold time	thd		5	--	--	ns	

Switching Waveform Characteristics

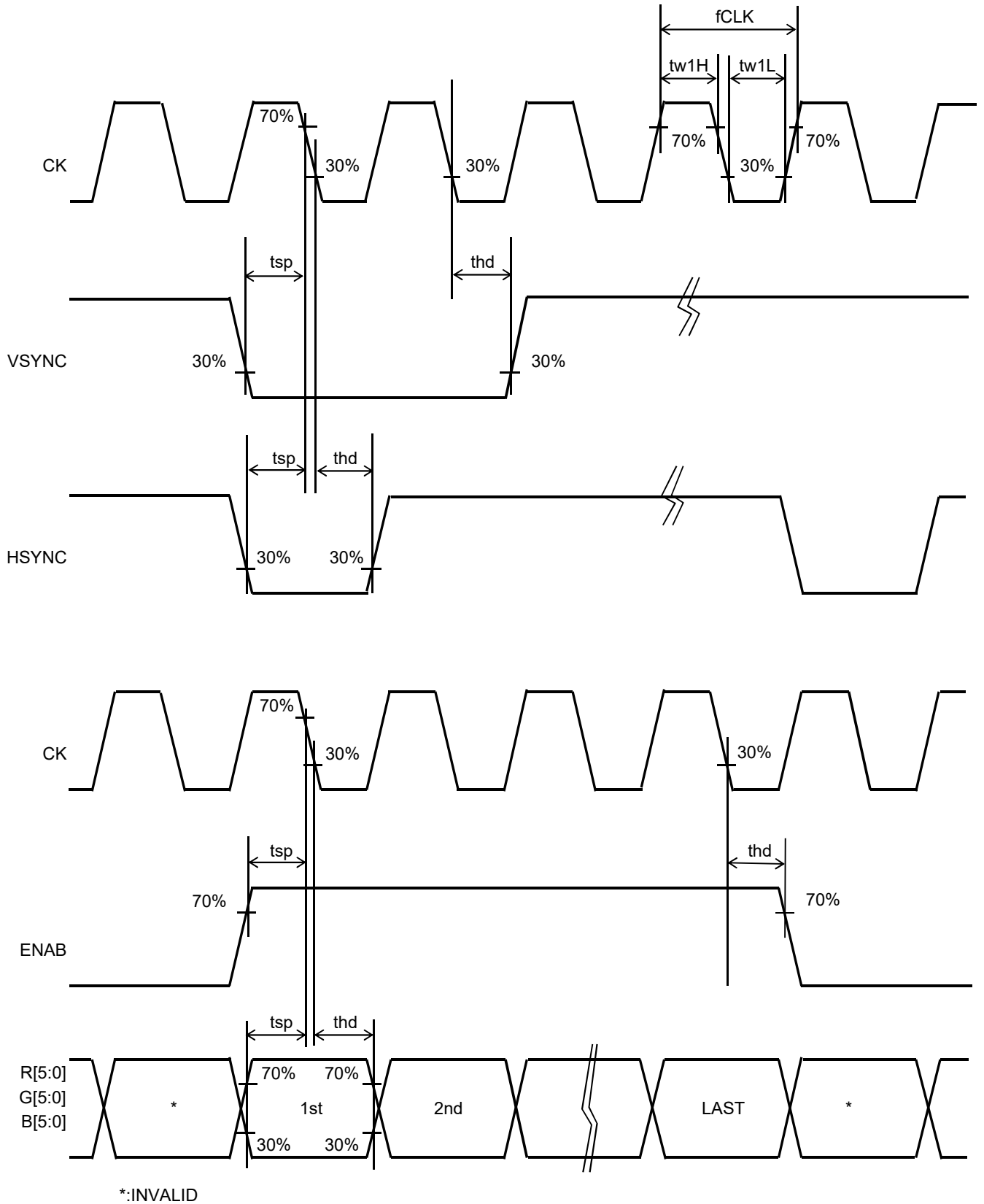

 8.3 Input Timing Characteristics

Item	Symbol	Rating			Unit	Applicable terminal
		MIN	TYP	MAX		
CLK frequency	fCLK	20.5	22.2	25.4	MHz	CK
VSYNC signal cycle time	Note2 Tv	490	528	576	H	VSYNC,HSYNC
VSYNC frequency	Note1 1/Tv	54	60	66	Hz	VSYNC
VSYNC pulse width	Tvpw	1	2	90	H	VSYNC,HSYNC
Vertical back porch	Note2 Tvbp	5	5	91	H	VSYNC,HSYNC,ENAB, R[5:0],G[5:0],B[5:0]
Vertical front porch	Note2 Tvfp	5	43	91	H	
Vertical display period	Tvd	480			H	
HSYNC signal cycle time	Note3 Th	696	700	736	CLK	HSYNC,CK
HSYNC pulse width	Thpw	1	2	76	CLK	
Horizontal back porch	Note3 Thbp	5	16	77	CLK	HSYNC,ENAB, R[5:0],G[5:0],B[5:0]
Horizontal front porch	Note3 Thfp	19	44	91	CLK	
Horizontal display period	Thd	640			CLK	

Note1: The characteristic of this item is recommended standard.

Please use it after it confirms it enough like the display fineness etc.

When it comes off from this characteristic and it is used.

Note2: VSYNC signal cycle time $T_v = T_{vbp} + T_{vfp} + T_{vd}$

Note3: HSYNC signal cycle time $T_h = T_{hbp} + T_{hfp} + T_{hd}$



8.4 Driving Timing Chart

When using in DE mode, VSYNC and HSYNC connect to VDD.

-Vertical Timing

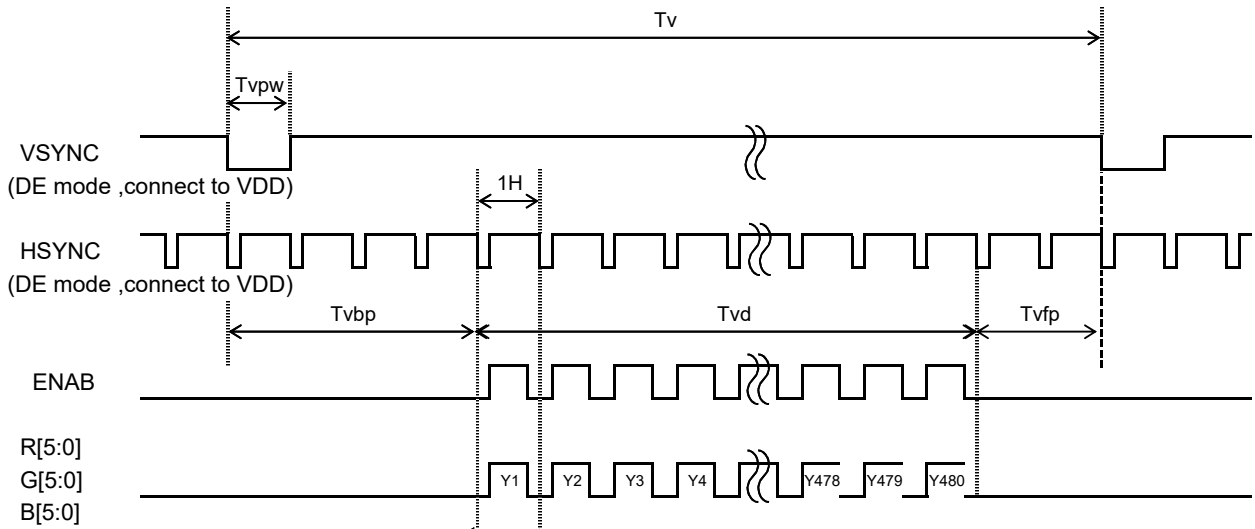

-Horizontal Timing

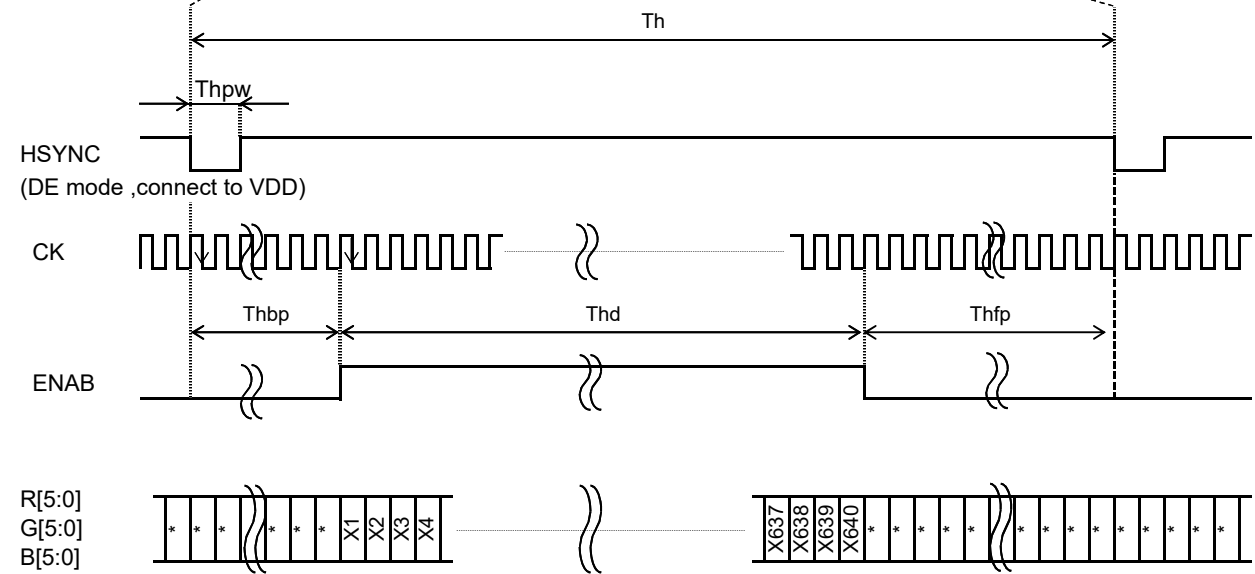



8.5 Example of Driving Timing Chart

-Vertical Timing

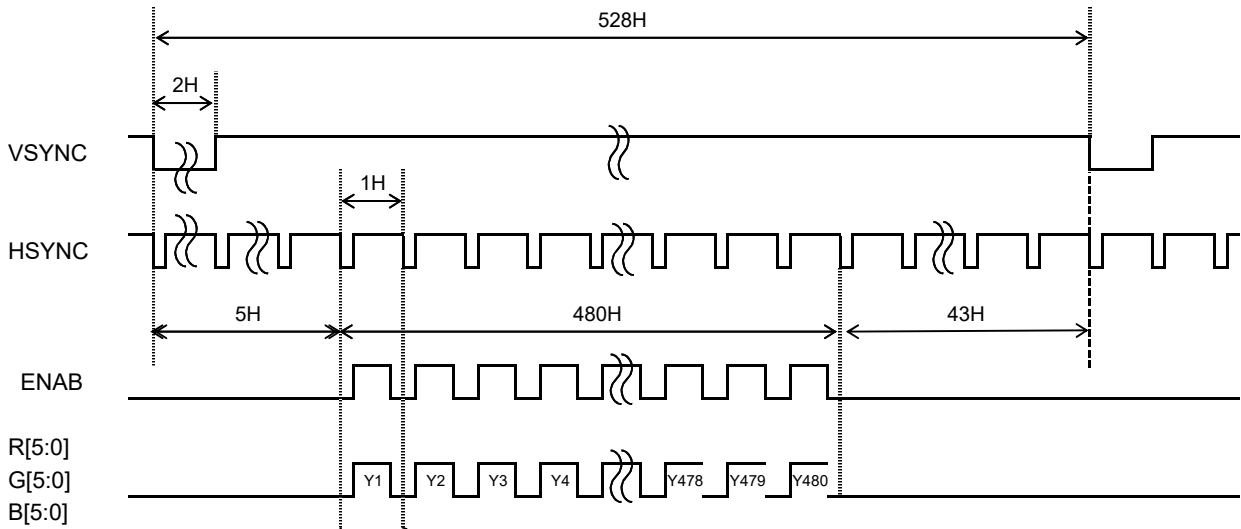

-Horizontal Timing

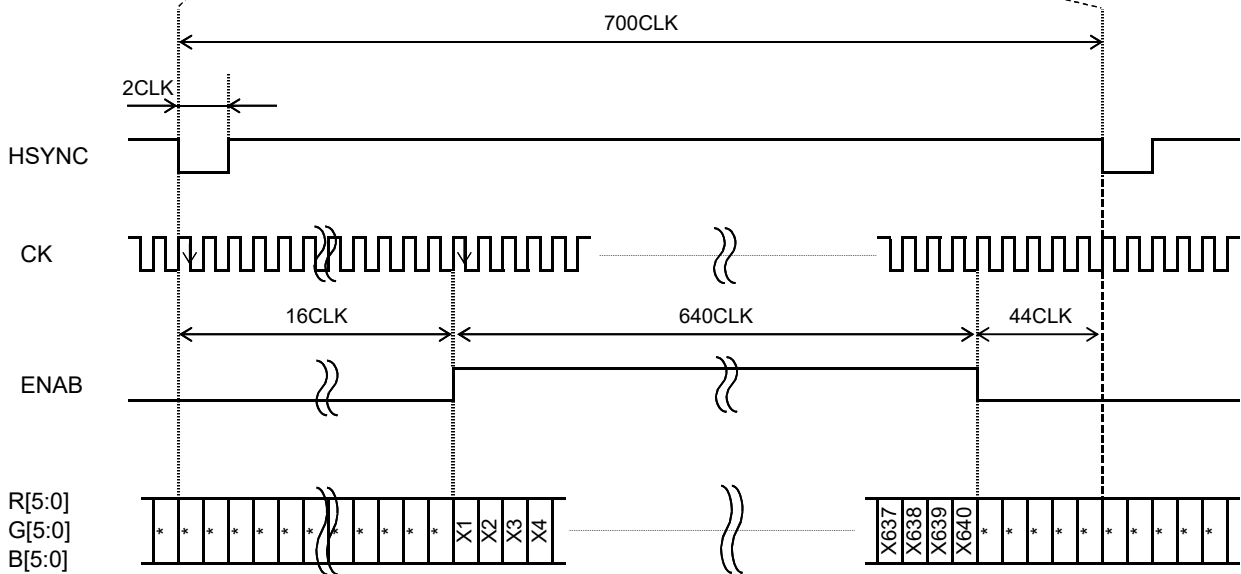

9. Description of Sequence

9.1 Power ON Sequence

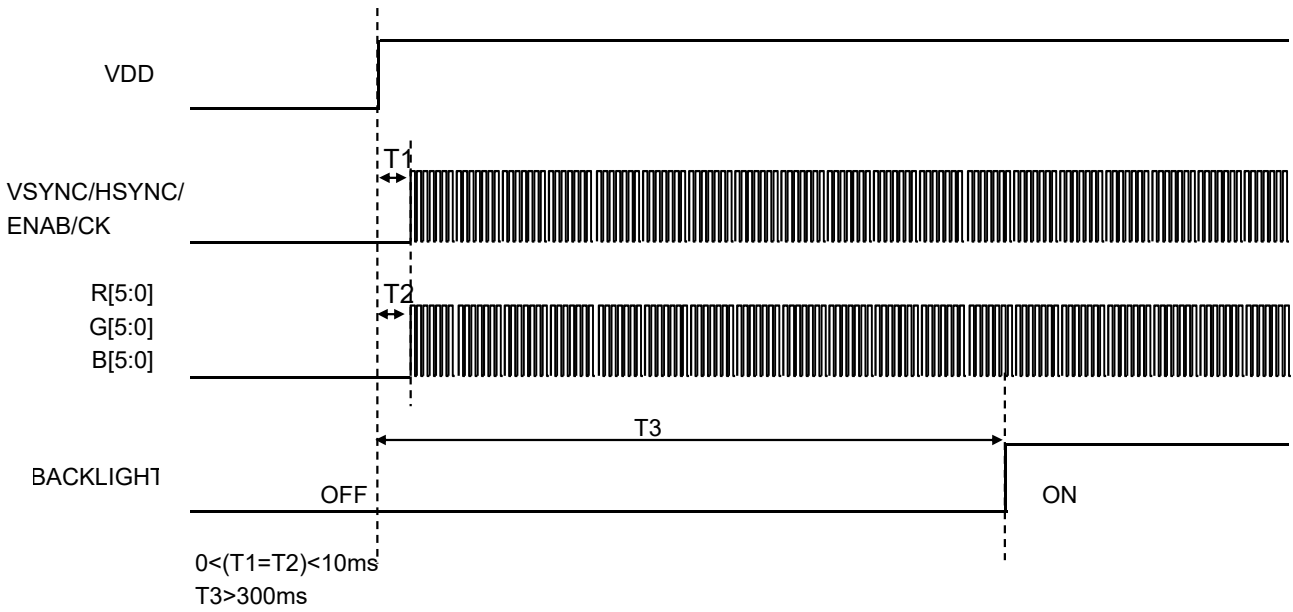

9.2 Power OFF Sequence

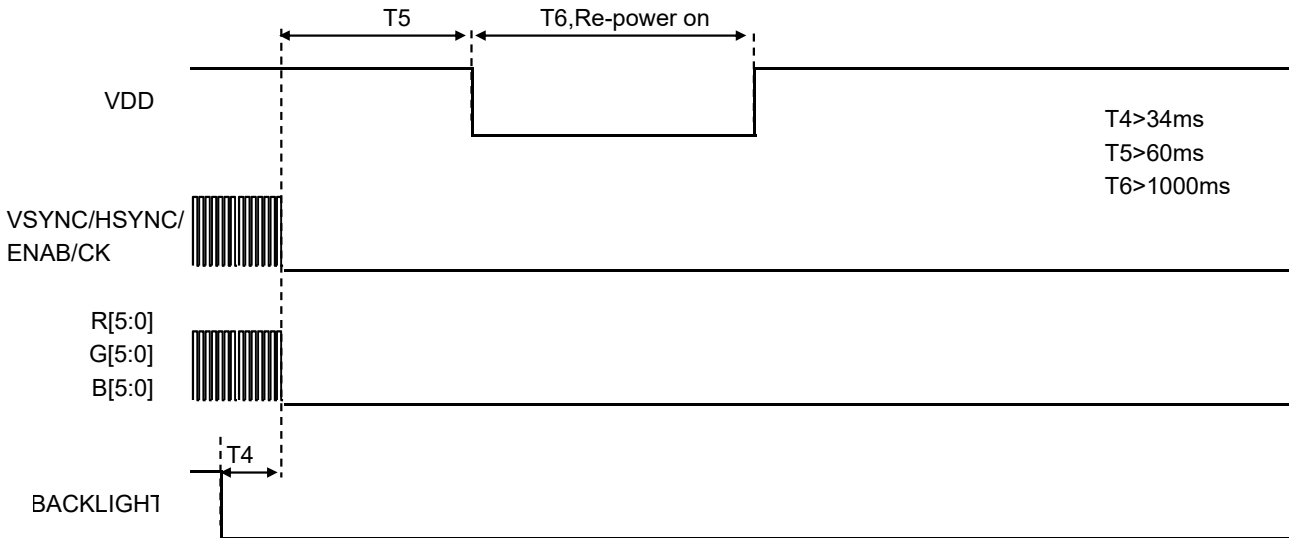

10. LED Circuit

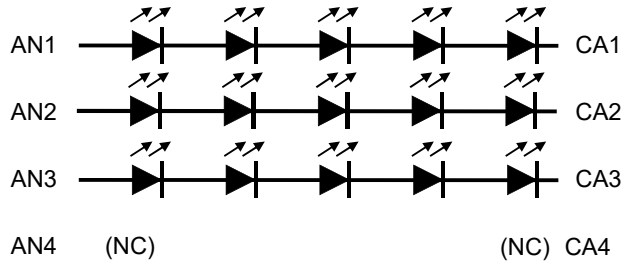

11. Characteristics

11.1 Optical Characteristics

< Measurement Condition >

Measuring instruments: CS2000 (KONICA MINOLTA) , LCD7200(OTSUKA ELECTRONICS) ,
EZcontrast XL88 (ELDIM)

Driving condition: VDD = 3.3V, GND = 0V

Optimized VCOMDC

Backlight: IL=15mA

*Current value per circuit line (AN1-CA1, AN2-CA2, & AN3-CA3)

Measured temperature: Ta=25°C

Item	Symbol	Condition	MIN	TYP	MAX	Unit	Note No.	Remark
Response time	Rise time	TON	[Data]= 00h → 3Fh	—	—	60	ms	1
	Fall time	TOFF	[Data]= 3Fh → 00h	—	—	40	ms	
Contrast ratio	CR	[Data]= 3Fh / 00h	700	1000	—		2	
Viewing angle	Left	θL	[Data]= 3Fh / 00h CR ≥ 10	—	80	—	deg	3
	Right	θR		—	80	—	deg	
	Up	φU		—	80	—	deg	
	Down	φD		—	80	—	deg	
White Chromaticity	x	[Data]=3Fh	0.265	0.315	0.365		4	
	y		0.285	0.335	0.385			
Center brightness		[Data]=3Fh	350	500	—	cd/m ²	5	
Brightness distribution		[Data]=3Fh	70	—	—	%	6	
NTSC ratio			—	50	—	%		

* Note number 1 to 6: Refer to the APPENDIX of "Reference Method for Measuring Optical Characteristics".

11.2 Temperature Characteristics

< Measurement Condition >

Measuring instruments: CS2000 (KONICA MINOLTA) , LCD7200(OTSUKA ELECTRONICS) ,

Driving condition: VDD = 3.3V, GND = 0V

Optimized VCOMDC

Backlight: IL=15mA

*Current value per circuit line (AN1-CA1, AN2-CA2, & AN3-CA3)

Item	Symbol	Specification		Remark
		Ta=-20°C	Ta=70°C	
Contrast ratio	CR	200 or more	200 or more	Backlight ON
Response time	Rise time	TON	300 msec or less	50 msec or less
	Fall time	TOFF	200 msec or less	30 msec or less
Display Quality		No noticeable display defect or ununiformity should be observed.		

12. Inspection Criteria

12.1 Inspection Condition

12.1.1 Environmental conditions

The environmental conditions for inspection shall be as follows

Room temperature: $23\pm 5^{\circ}\text{C}$

Humidity: $50\pm 20\% \text{RH}$

12.1.2 The external visual inspection

With a single 1000 ± 200 lux fluorescent lamp as the light source, the inspection was in the distance of 30cm or more from the LCD to the inspector's eyes.

12.2 Light Method

Environment lamp under 1000 ± 200 lux,

Viewing direction for inspection over 300mm.

The distance from eye to defect around 300mm, the distance from ND Filter to defect around 25~30mm

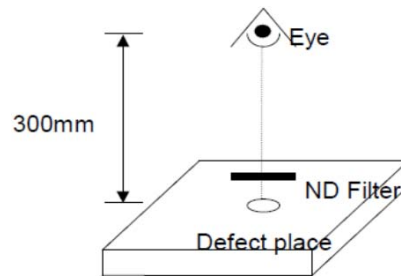

12.3 Definition Of Inspection Area

A.A.:Active Area (X:115.20mm, Y:86.40mm)

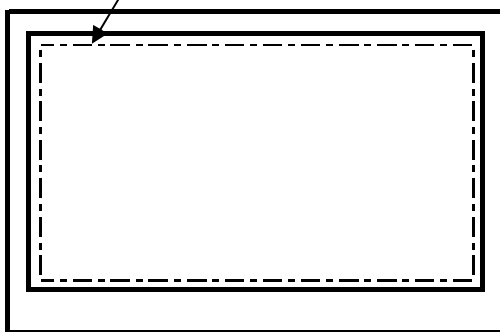

13. Item and Criteria

13.1 Visual inspection criterion in cosmetic

13.1.1 LCM appearance defect with in A.A.

Item	Criteria		
Round type	Spec	Permissible Q'ty	$\varphi = (L + W) / 2$ L : Length W : Width
	$\varphi < 0.20\text{mm}$	Disregard	
	$0.20\text{mm} \leq \varphi \leq 0.50\text{mm}$	5	
	$0.50\text{mm} < \varphi$	0	
Liner type	Spec	Permissible Q'ty	L : Length W : Width
	$L \leq 10\text{mm}$ and $W \leq 0.10\text{mm}$	Disregard	
	$L \leq 10\text{mm}$ and $0.10\text{mm} < W \leq 0.25\text{mm}$	4	
	$10\text{mm} < L$ or $0.25\text{mm} < W$	0	
Polarizer Bubble	Spec	Permissible Q'ty	$\varphi = (L + W) / 2$ L : Length W : Width
	$\varphi < 0.25\text{mm}$	Disregard	
	$0.25\text{mm} \leq \varphi \leq 0.50\text{mm}$	2	
	$0.50\text{mm} < \varphi$	0	
Polarizer Dent	Spec	Permissible Q'ty	
	$\varphi < 0.25\text{mm}$	Disregard	
	$0.25\text{mm} \leq \varphi \leq 0.50\text{mm}$	4	
	$0.50\text{mm} < \varphi$	0	

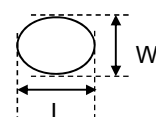
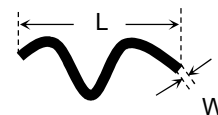
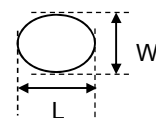

13.2 Defective Display and Screen Quality

Item	Defect content	Criteria		
Defective Display	Line defect 	Reject		
	Dot defect	Uneven brightness on dot-by-dot base due to defective TFT or CF, or dust is counted as dot defect Refer to Table 1 Note1) 1dot : 1R / 1G / 1B Note2) Point defect area $\geq 1/2$ dot.		
Item	Criteria			
Screen Quality	Round type	Spec	Permissible Q'ty	$\phi = (L + W) / 2$ L: Length W: Width 
		$\phi < 0.20\text{mm}$	Disregard	
		$0.20\text{mm} \leq \phi \leq 0.50\text{mm}$	5	
		$0.50\text{mm} < \phi$	0	
	Liner type	Spec	Permissible Q'ty	L: Length W: Width 
		$L \leq 10\text{mm}$ and $W \leq 0.10\text{mm}$	Disregard	
$L \leq 10\text{mm}$ and $0.10\text{mm} < W \leq 0.25\text{mm}$		4		
$10\text{mm} < L$ or $0.25\text{mm} < W$		0		
Mura	Black	Invisible through 10% ND filter		
	White / Gray / R / G / B	Invisible through 5% ND filter		

Table 1

Item	Zone		Total
	A	B	
Bright dot	0		0
Dark dot	1		1
Bright dot + Dark dot	1		1
Two adjacent dot	Reject		-

(Zone)



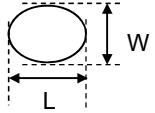
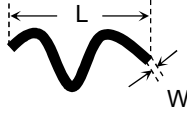
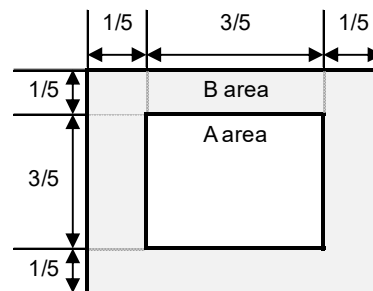

14. Reliability Test

Test Item		Test condition	Number of failures / Number of examinations
Durability test	High temperature storage	Ta = 80°C 240hrs	0 / 3
	Low temperature storage	Ta = -30°C 240hrs	0 / 3
	High temperature and High humidity storage	Ta = 60°C, RH = 90% non condensing ※	0 / 3
	High temperature operation	Tp = 70°C 240hrs	0 / 3
	Low temperature operation	Tp = -20°C 240hrs	0 / 3
	High temperature and High humidity operation	Tp = 40°C, RH = 90% non condensing ※	0 / 3
	Thermal shock storage	-30°C ↔ 80°C (30min/30min) 100cycle	0 / 3
	Mechanical test	Surface discharge test (Non operation)	C = 250pF, R = 100Ω, V = ±12kV Each 5 times of discharge in both polarities on the center of screen with the case grounded.
Vibration test		Total amplitude 1.5mm, f = 10~55Hz, X,Y,Z directions for each 1 hours	0 / 3
Packing test	Packing vibration-proof test	Acceleration of 19.6m/s ² with frequency of 10→55→10Hz, X,Y, Zdirection for each 30 minutes	0 / 1 packing
	Packing drop test	Drop from 70cm high. 1 time to each 6 surfaces, 3 edges, 1 corner	0 / 1 packing

Note: Ta = ambient temperature / Tp = Panel temperature

※ The profile of high temperature / humidity storage and High Temperature/humidity operation (Pure water of over 10MΩ·cm shall be used.)

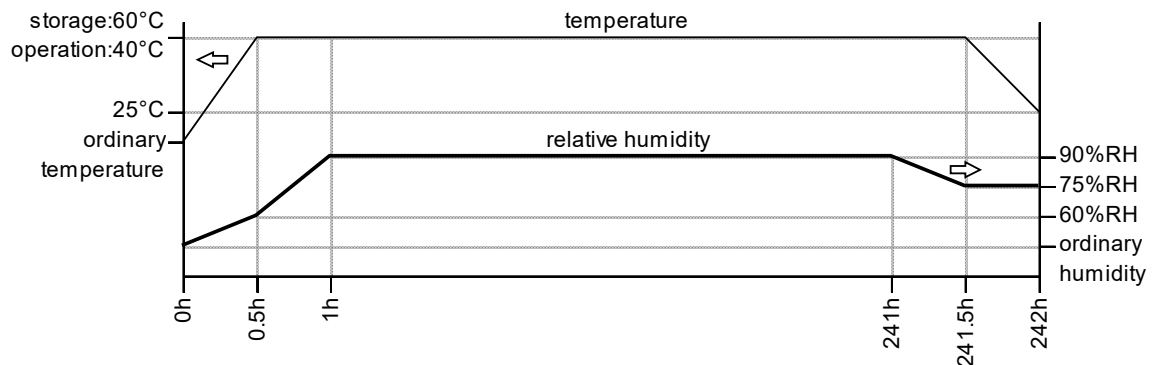

Reliability Criteria

Measure the parameters after leaving the monitor at the ordinary temperature for 24 hours or more after the test completion.

Item	Standard	Remark
Display quality	No visible abnormality shall be seen.	
Contrast ratio	200 or more	Backlight ON



15. Packing Specifications

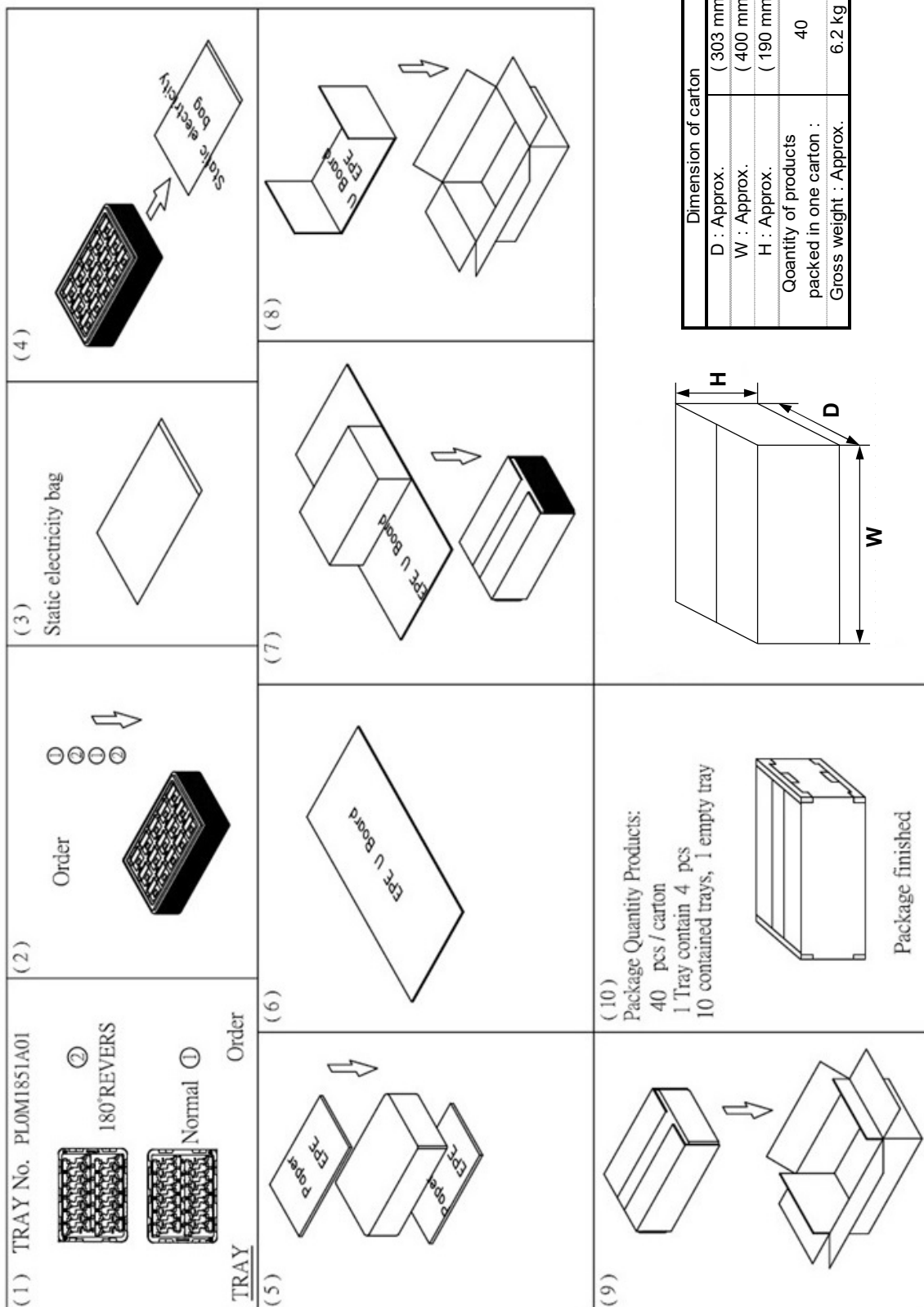

Dimension of carton	
D : Approx.	(303 mm)
W : Approx.	(400 mm)
H : Approx.	(190 mm)
Quantity of products packed in one carton :	40
Gross weight : Approx.	6.2 kg

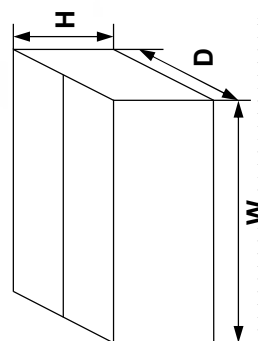

Note:

1. Tape on the carton.
2. Stored up the by 11 trays then put it in to the static electricity bag and seal it as well.

16. Handling Instruction

16.1 Cautions for Handling LCD panels

**Caution**

- (1) Do not make an impact on the LCD panel glass because it may break and you may get injured from it.
- (2) If the glass breaks, do not touch it with bare hands.
(Fragment of broken glass may stick you or you cut yourself on it.)
- (3) If you get injured, receive adequate first aid and consult a medial doctor.
- (4) Do not let liquid crystal get into your mouth.
(If the LCD panel glass breaks, try not let liquid crystal get into your mouth even toxic property of liquid crystal has not been confirmed.)
- (5) If liquid crystal adheres, rinse it out thoroughly.
(If liquid crystal adheres to your cloth or skin, wipe it off with rubbing alcohol or wash it thoroughly with soap. If liquid crystal gets into eyes, rinse it with clean water for at least 15 minutes and consult an eye doctor.)
- (6) If you scrap this products, follow a disposal standard of industrial waste that is legally valid in the community, country or territory where you reside.
- (7) Do not connect or disconnect this product while its application products is powered on.
- (8) Do not attempt to disassemble or modify this product as it is precision component.
- (9) If a part of soldering part has been exposed, and avoid contact (short-circuit) with a metallic part of the case etc. about substrate of this model, please. Please insulate it with the insulating tape etc. if necessary.
The defective operation is caused, and there is a possibility to generation of heat and the ignition.
- (10) The devices on the substrate are damageable to electrostatic discharge, because the terminals of the devices are exposed.
Wear grounded wrist-straps and use electrostatic neutralization blowers to prevent static charge and discharge when handling the TFT monitors.
Designate an appropriate operating area, and set equipment, tools, and machines properly when handling this product.
- (11) Since excess current protection circuit is not built in this TFT module, there is the possibility that LCD module or peripheral circuit become feverish and burned in case abnormal operation is generated.
We recommend you to add excess current protection circuit to power supply.

**Caution**

This mark is used to indicate a precaution or an instruction which, if not correctly observed, may result in bodily injury, or material damages alone.

16.2 Precautions for Handling

- 1) Wear finger tips at incoming inspection and for handling the TFT monitors to keep display quality and keep the working area clean.
Do not touch the surface of the monitor as it is easily scratched.
- 2) Wear grounded wrist-straps and use electrostatic neutralization blowers to prevent static charge and discharge when handling the TFT monitors as the LED in this TFT monitors is damageable to electrostatic discharge.
Designate an appropriate operating area, and set equipment, tools, and machines properly when handling this product.
- 3) Avoid strong mechanical shock including knocking, hitting or dropping to the TFT monitors for protecting their glass parts. Do not use the TFT monitors that have been experienced dropping or strong mechanical shock.
- 4) Do not use or storage the TFT monitors at high temperature and high humidity environment. Particularly, never use or storage the TFT monitors at a location where condensation builds up.
- 5) Avoid using and storing TFT monitors at a location where they are exposed to direct sunlight or ultraviolet rays to prevent the LCD panels from deterioration by ultraviolet rays.
- 6) Do not stain or damage the contacts of the FPC cable .
FPC cable needs to be inserted until it can reach to the end of connector slot.
During insertion, make sure to keep the cable in a horizontal position to avoid an oblique insertion.
Otherwise, it may cause poor contact or deteriorate reliability of the FPC cable.
- 7) Peel off the protective film on the TFT monitors during mounting process.
Refer to the section 16.5 on how to peel off the protective film.
We are not responsible for electrostatic discharge failures or other defects occur when peeling off the protective film.

16.3 Precautions for Operation

- 1) In case of powering up or powering off this LCD module,
be sure to comply the sequence as instructed in this specification.
- 2) Do not plug in or out the connector while power supply is switch on.
Plug the connector in and out while power supply is switched off.
- 3) Do not operate the TFT monitors in the strong magnetic field. It may break the TFT monitors.
- 4) Do not display a fixed image on the screen for a long time.
Use a screen-saver or other measures to avoid a fixed image displayed on the screen for a long time.
Otherwise, it may cause burn-in image on the screen due the characteristics of liquid crystal.



16.4 Storage Condition for Shipping Cartons

Storage environment

- Temperature 0 to 40° C
- Humidity 60%RH or less
No-condensing occurs under low temperature with high humidity condition.
- Atmosphere No poisonous gas that can erode electronic components and/or wiring materials should be detected.
- Time period 1 year
- Unpacking To prevent damages caused by static electricity, anti-static precautionary measures (e.g. earthing, anti-static mat) should be implemented.
After unpack, keep product in the appropriate condition, otherwise bubble seal of Protective film may be printed on Polarizer.
- Maximum piling up 5 cartons

*Conditions to storage after unpacking

Storage environment

- Temperature 0 to 40° C
- Humidity 60%RH or less
No-condensing occurs under low temperature with high humidity condition.
- Atmosphere No poisonous gas that can erode electronic components and/or wiring materials should be detected.
- Time period 1 year (Shelf life)
- Others Keep/ store away from direct sunlight
Storage goods on original tray made by TOPPAN.

16.5 Precautions for Peeling off the Protective film

The followings work environment and work method are recommended to prevent the TFT monitors from static damage or adhesion of dust when peeling off the protective films.

A) Work Environment

- a) Humidity: 50 to 70 %RH, Temperature 15 to 27° C
- b) Operators should wear conductive shoes, conductive clothes, conductive finger tips and grounded wrist-straps.
Use an electrostatic neutralization blower.
Anti-static treatment should be implemented to work area's floor.
- c) Use a room shielded against outside dust with sticky floor mat laid at the entrance to eliminate dirt.

B) Work Method

The following procedures should taken to prevent the driver ICs from charging and discharging.

- a) Use an electrostatic neutralization blower to blow air on the TFT monitors to its lower left.
Optimize direction of the blowing air and the distance between the TFT monitors and the electrostatic neutralization blower.
- b) Peel off the Tab of Protection film slowly (spending more than 2 secs to complete) by pulling it to opposite direction.

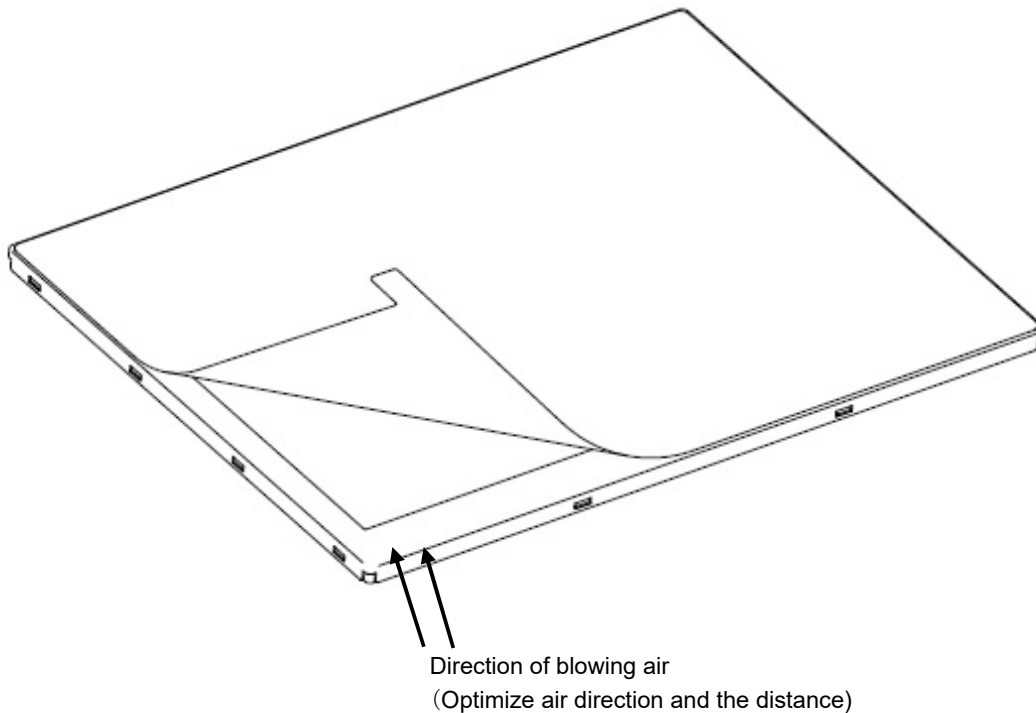

16.6 Warranty

TOPPAN is only liable to defective goods which is stored and used under the condition complying with this specifications and returned within 1 (one) year.

Warranty caused by manufacturing defect shall be conducted by replacement of goods or refundment at unit price.

APPENDIX

Reference Method for Measuring Optical Characteristics and Performance

1. Measurement Condition

Measuring instruments: CS2000 (KONICA MINOLTA) , LCD7200(OTSUKA ELECTRONICS) ,EZcontrast XL88 (ELDIM)

Driving condition: Refer to the section "Optical Characteristics"

Measured temperature: 25°C unless specified

Measurement system: See the chart below. The luminance meter is placed on the normal line of measurement system.

Measurement point: At the center of the screen unless otherwise specified

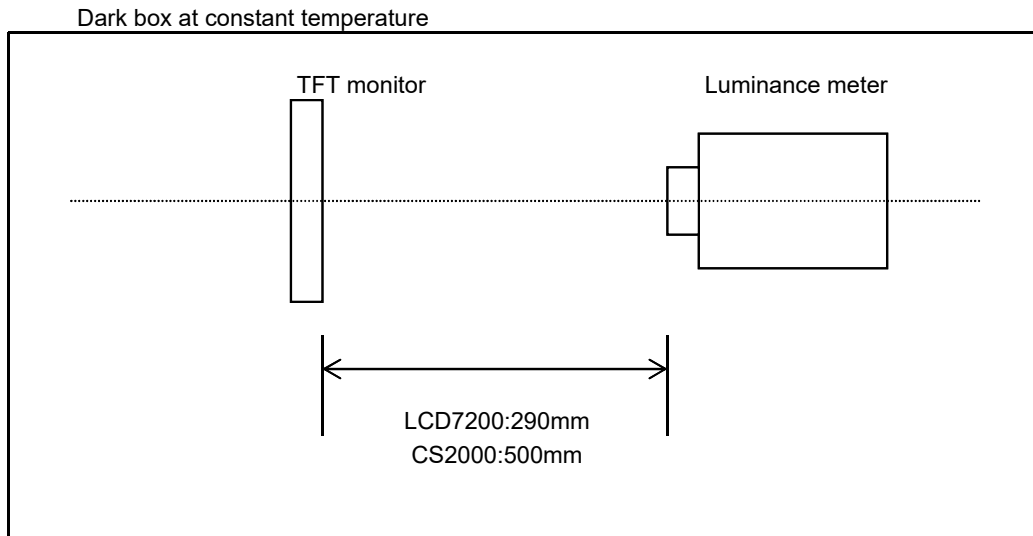

Measurement is made after 30 minutes of lighting of the backlight.

Measurement point: At the center point of the screen

Brightness distribution: 9 points shown in the following drawing.

<Landscape model>

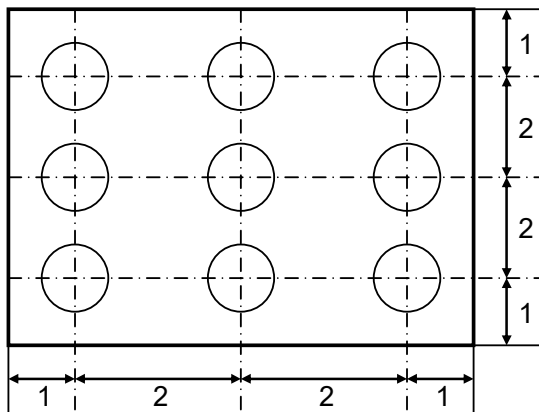

Dimensional ratio of active area

Backlight IL=15mA

*Current value per circuit line (AN1-CA1, AN2-CA2, & AN3-CA3)

2. Test Method

Notice	Item	Test method	Measuring instrument	Remark
1	Response time	<p>Measure output signal waveform by the luminance meter when raster of window pattern is changed from white to black and from black to white.</p> <p style="text-align: center;">Black White Black</p> <p>White brightness</p> <p>100%</p> <p>90%</p> <p>10%</p> <p>0%</p> <p>Black brightness</p> <p>TON</p> <p>TOFF</p>	LCD7200	Black display [Data]=00h White display [Data]=3Fh TON Rise time TOFF Fall time
2	Contrast ratio	<p>Measure maximum luminance $Y1$ ([Data]=3Fh) and minimum luminance $Y2$ ([Data]=00h) at the center of the screen by displaying raster or window pattern. Then calculate the ratio between these two values.</p> <p style="text-align: center;">Contrast ratio = $Y1/Y2$</p> <p style="text-align: center;">Diameter of measuring point: 7.8mmϕ</p>	CS2000	
3	Viewing angle Horizontal θ Vertical ϕ	Move the luminance meter from right to left and up and down and determine the angles where contrast ratio is 10.	EZcontrast XL88	
4	White chromaticity	<p>Measure chromaticity coordinates x and y of CIE1931 colorimetric system at [Data] = 3Fh</p> <p style="text-align: center;">Color matching function: 2°view measurement angle: 1°</p>	CS2000	
5	Center brightness	Measure the brightness at the center of the screen.	CS2000	
6	Brightness distribution	<p>(Brightness distribution) = $100 \times B/A \%$</p> <p>A : max. brightness of the 9 points</p> <p>B : min. brightness of the 9 points</p>	CS2000	