

# Specifications for

## Blanview TFT-LCD Monitor

( 2.7" QVGA 240 x RGB x 320 Portrait)

Version 1.0

(Please be sure to check the specifications latest version. )

MODEL COM27H2P86ULC

Customer's Approval

Signature :

Name :

Section :

Title :

Date :

# ORTUSTECH



TOPPAN INC.  
Electronics Division  
Ortus Subdivision

Approved by

S. Epuclii

Checked by

J. Matsuzaki

Prepared by

M. Tojo

## Version History

Ver.	Date	Page	Description
0.0	Oct.5,2022	-	- Tentative issue
1.0	May.19,2023	-	- First issue
△ ×10		P.1	Cover
		Change	Department name
		P.5	2.1 Features of the Product
		Correct	Model overview
		Change	2.2 Display Method
		P.11	Signal input method
		5. Absolute Maximum Rating	
		Delete	Condition (Supply voltage/Input voltage for logic)
		P.12	7.1 DC Characteristics
		Add	Rating
		P.13	8. Switching Waveform Characteristics
		Correct	DH hold Specified waveform
		P.14	9.1 Input Timing Characteristics
		Correct	Item,Rating
P.16	9.3 Example of Driving Timing Chart (fCLK=5.6MHz)		
Add	Example of Driving Timing Chart		
P.22	15.1 Defective Display and Screen Quality		
Add	Signal condition		
P.24	16. Reliability Test		
Add	number of failures /number of examinations		
Add	Test condition (Surface discharge test(Non operation))		

## Contents

1. Application	.....	4
2. Outline Specifications		
2.1 Features of the Product	.....	5
2.2 Display Method	.....	5
3. Dimensions and Shape		
3.1 Dimensions	.....	7
3.2 Outward Form	.....	8
3.3 Serial № print (S-print)	.....	9
4. Pin Assignment	.....	10
5. Absolute Maximum Rating	.....	11
6. Recommended Operating Conditions	.....	11
7. Electrical Characteristics		
7.1 DC Characteristics	.....	12
7.2 AC Characteristics	.....	12
8. Switching Waveform Characteristics	.....	13
9. Input Timing		
9.1 Input Timing Characteristics	.....	14
9.2 Driving Timing Chart	.....	15
9.3 Example of Driving Timing Chart	.....	16
10. Power ON/OFF sequence	.....	17
11. Display ON/OFF sequence	.....	18
12. Reset sequence	.....	18
13. LED Circuit	.....	19
14. Characteristics		
14.1 Optical Characteristics	.....	20
14.2 Temperature Characteristics	.....	21
15. Criteria of Judgment		
15.1 Defective Display and Screen Quality	.....	22
15.2 Screen and Other Appearance	.....	23
16. Reliability Test	.....	24
17. Packing Specifications	.....	26
18. Handling Instruction		
18.1 Cautions for Handling LCD panels	.....	27
18.2 Precautions for Handling	.....	28
18.3 Precautions for Operation	.....	28
18.4 Storage Condition for Shipping Cartons	.....	29
18.5 Precautions for Peeling off the Protective film	.....	30
18.6 Warranty	.....	30
APPENDIX	.....	31

## 1. Application

This Specification is applicable to 68.4 mm (2.7 inch) Blanview TFT-LCD monitor for non-military use.

- ◎ TOPPAN makes no warranty or assume no liability that use of this Product and/or any information including drawings in this Specification by Purchaser is not infringing any patent or other intellectual property rights owned by third parties, and TOPPAN shall not grant to Purchaser any right to use any patent or other intellectual property rights owned by third parties. Since this Specification contains TOPPAN's confidential information and copy right, Purchaser shall use them with high degree of care to prevent any unauthorized use, disclosure, duplication, publication or dissemination of TOPPAN's confidential information and copy right.
- ◎ If Purchaser intends to use this Products for an application which requires higher level of reliability and/or safety in functionality and/or accuracy such as transport equipment (aircraft, train, automobile, etc.), disaster-prevention/security equipment or various safety equipment, Purchaser shall consult TOPPAN on such use in advance.
- ◎ This Product shall not be used for application which requires extremely higher level of reliability and/or safety such as aerospace equipment, telecommunication equipment for trunk lines, control equipment for nuclear facilities or life-support medical equipment.
- ◎ It must be noted as an mechanical design manner, especial attention in housing design to prevent arcuation/flexure caused by stress to the LCD module shall be considered.
- ◎ TOPPAN assumes no liability for any damage resulting from misuse, abuse, and/or miss-operation of the Product deviating from the operating conditions and precautions described in the Specification.
- ◎ It shall be mutually conferred if nonconforming defect which result from unspecified cause in this specification arises.
- ◎ If any issue arises as to information provided in this Specification or any other information, TOPPAN and Purchaser shall discuss them in good faith and seek solution.
- ◎ TOPPAN assumes no liability for defects such as electrostatic discharge failure occurred during peeling off the protective film or Purchaser's assembly process.
- ◎ This Product is compatible for RoHS(2.0) directive.

Object substance	Maximum content [ppm]
Cadmium and its compound	100
Hexavalent Chromium Compound	1000
Lead & Lead compound	1000
Mercury & Mercury compound	1000
Polybrominated biphenyl series (PBB series)	1000
Polybrominated biphenyl ether series (PBDE series)	1000
Bis(2-ethylhexyl)phthalate series(DEHP series)	1000
Butyl benzyl phthalate series(BBP series)	1000
Dibutyl phthalate series(DBP series)	1000
Diisobutyl phthalate series(DIBP series)	1000

2. Outline Specifications

**A** 2.1 Features of the Product

- 2.7" diagonal with resolution of 720[H]x320[V] dots. 240RGB x 320 pixel.
- 6-bit / 262,144 colors.
- Single power supply operation of 3V.
- Timing generator [TG], Counter-electrode driving circuitry, Built-in power supply circuit.
- Long life & High bright white LED back-light.
- Blanview TFT-LCD, improved outdoor readability.

	Indoor		Outdoor	
	Readability	Power Efficiency (Battery Life)	Readability	Power Efficiency (Battery Life)
Transmissive	Good	Good	Fair	Poor
Transflective	Fair	Poor	Good	Good
Blanview	Good	Good	Good	Good

**A** 2.2 Display Method

Items	Specifications	Remarks
Display type	VA type 262,144 Colors. Blanview, Normally Black.	
Driving method	a-Si TFT Active matrix Line-scanning, Non-interlace	
Dot arrangement	RGB stripe arrangement	Refer to Fig. 1
Signal input method	6-bit : RGB interface	
Backlight	Long life & High bright white LED.	
NTSC ratio	50%	

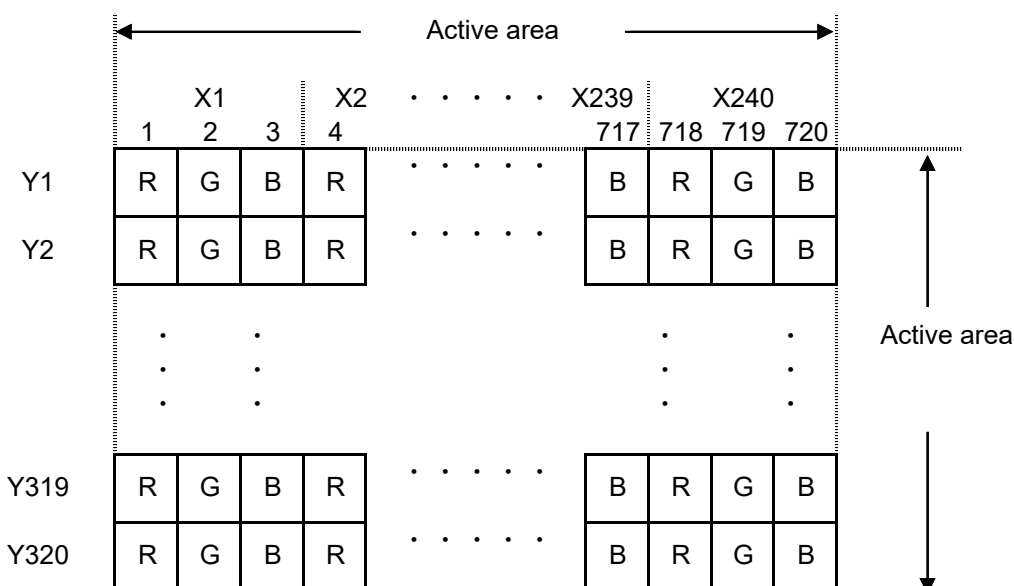
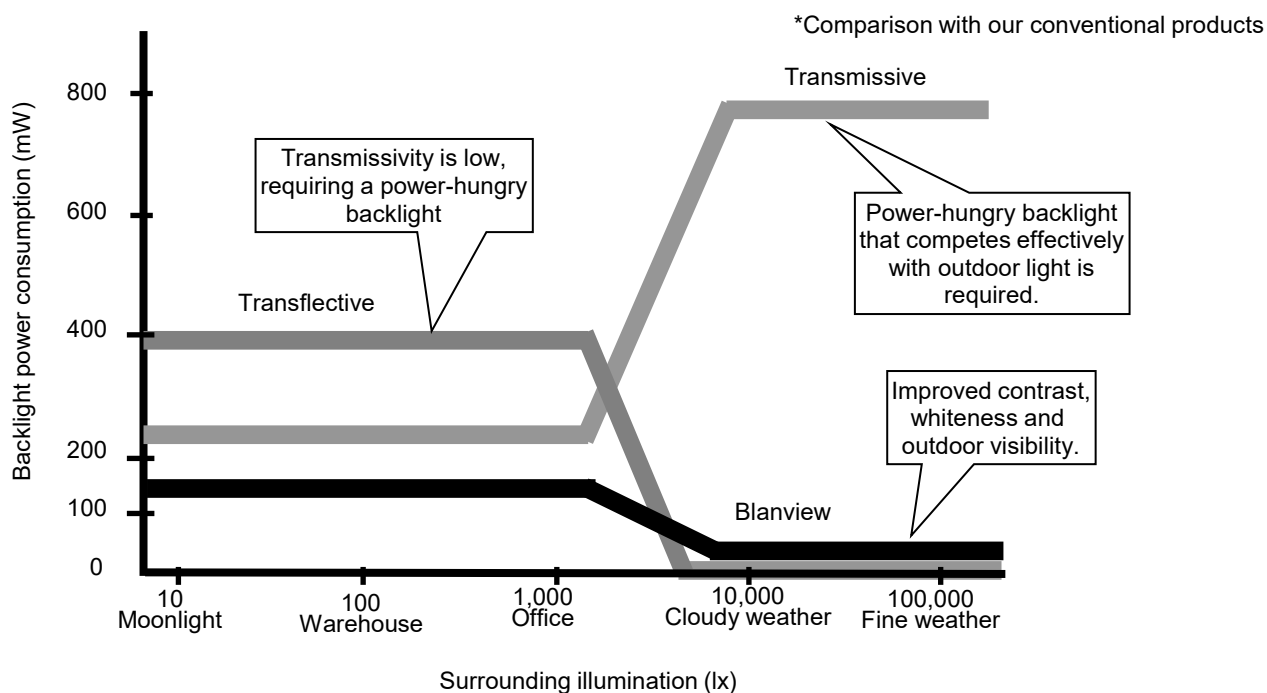

Fig. 1: Dot arrangement (FPC cable placed left)

<Features of Blanview>

- Backlight power consumption required to assure visibility. (equivalent to 3.5"QVGA )



- Contrast characteristics under 100,000lx. (same condition as direct sunlight.)

With better contrast (higher contrast ratio), Blanview TFT-LCD has the best outdoor readability in three different types of TFT-LCD.

Below chart shows contrast value against panel surface brightness. (Horizontal: Panel surface brightness/ Vertical: Contrast value) LCD panel has enough outdoor readability above our Standard line. (TOPPAN criteria)

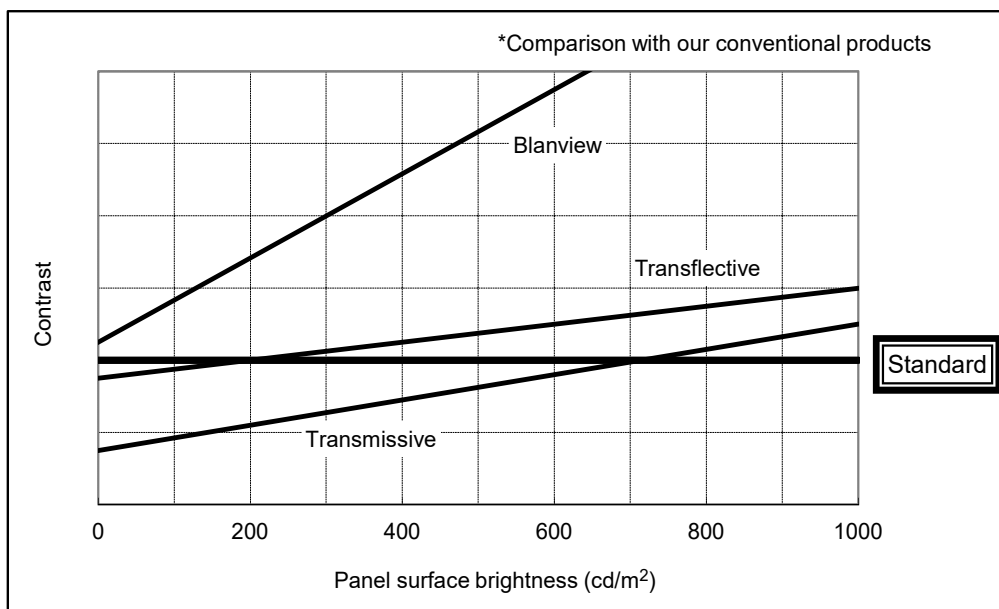

## 3. Dimensions and Shape

## 3.1 Dimensions

Items	Specifications	Unit	Remarks
Monitor outline dimensions	47.00[H] × 66.00[V] × 2.89[D]	mm	Exclude FPC cable and parts on FPC.
Active area	41.04[H] × 54.72[V]	mm	68.4mm diagonal
Number of dots	720[H] × 320[V]	dot	
Dot pitch	57.0[H] × 171.0[V]	μ m	
Surface hardness of the polarizer	2	H	
Weight	19.0	g	Include FPC cable

3.2 Outward Form

(8/33)  
22TLM046  
Issue: May.19,2023

EC No.	REV. No.	REVISE	DATE (Y:M:D)	APPROVED	CHECKED	PREPARED
###			##:##:##	##	##	

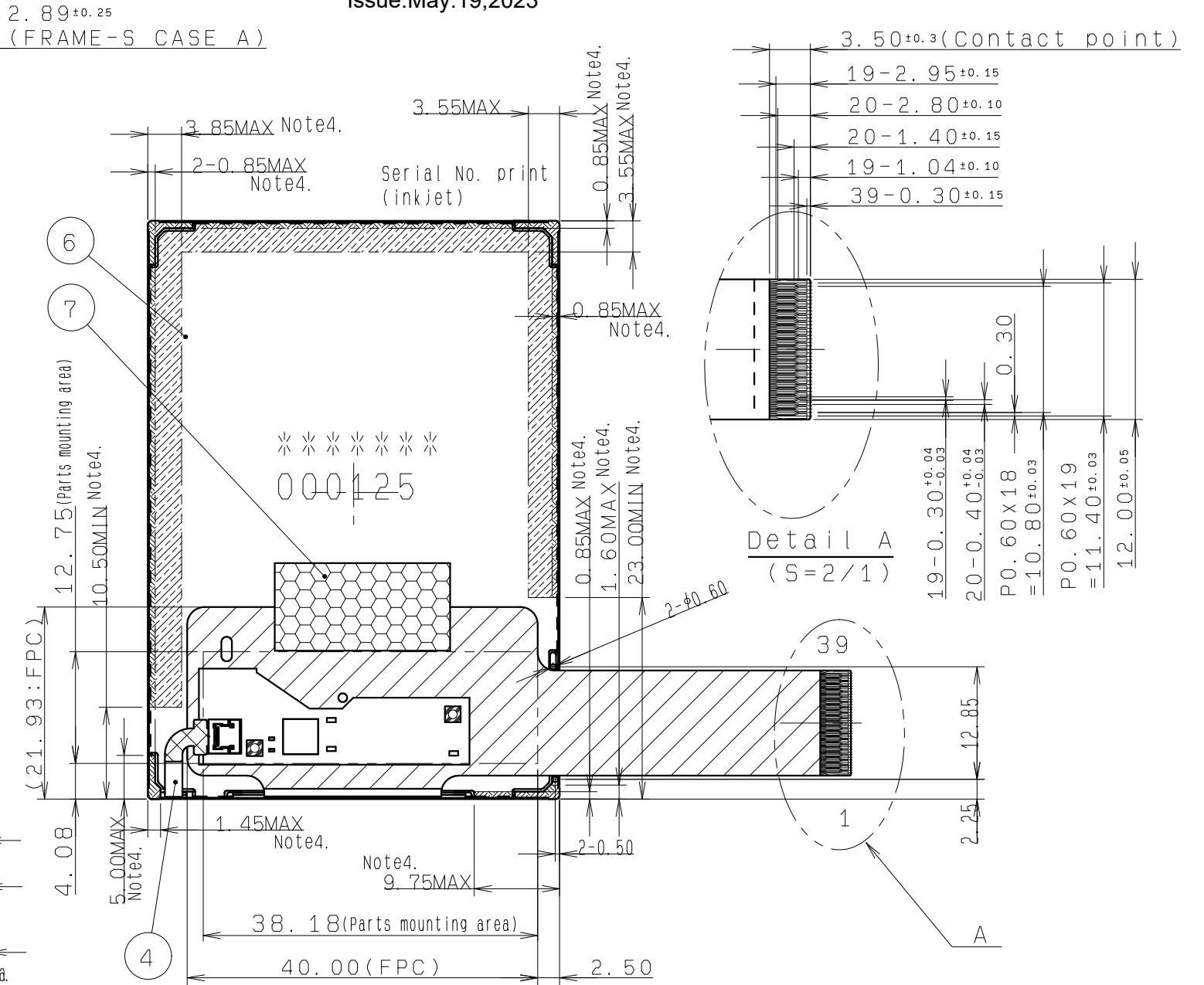
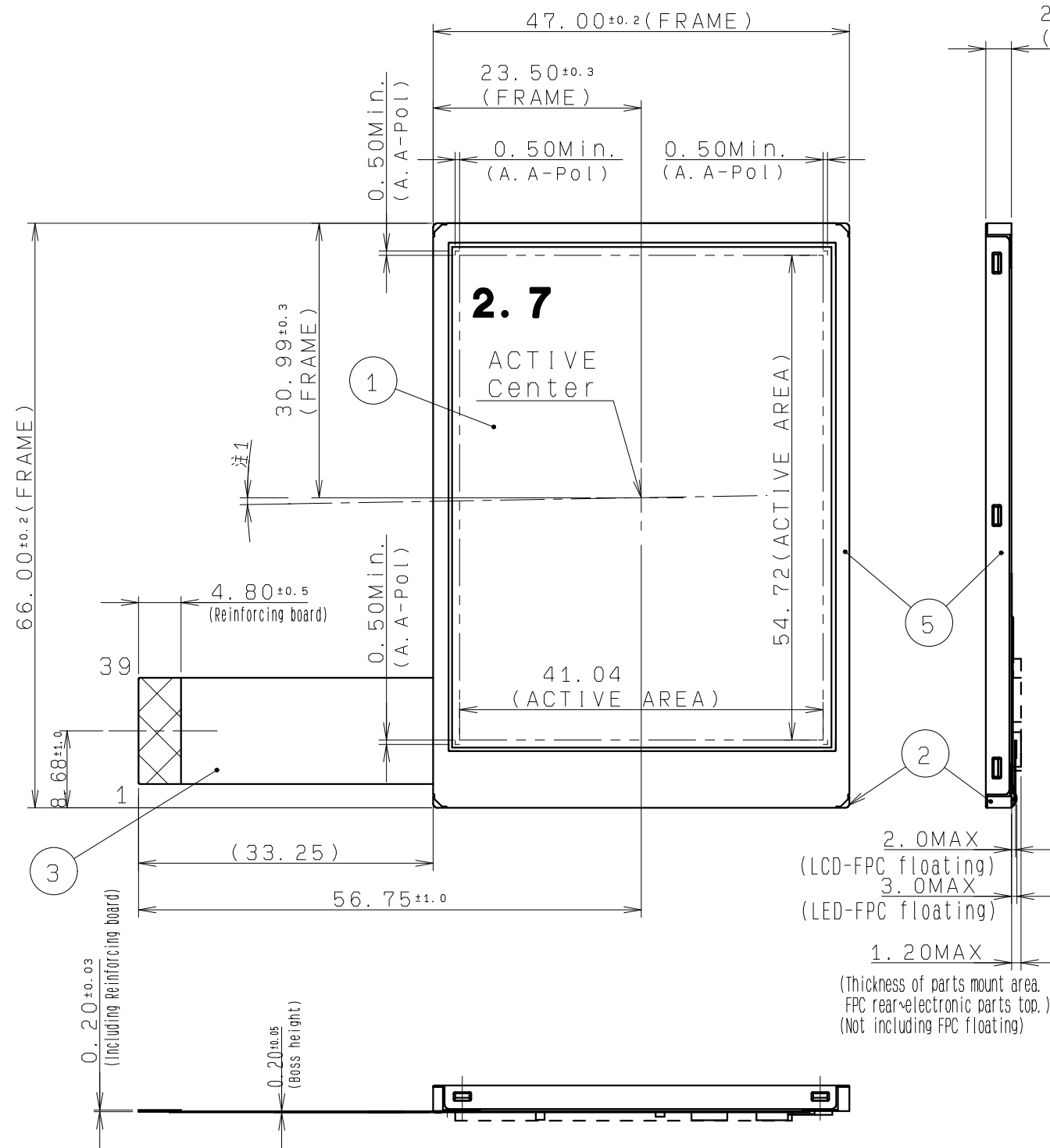

2.0MAX (LCD-FPC floating)  
3.0MAX (LED-FPC floating)  
1.20MAX (Thickness of parts mount area. FPC rear-electronic parts top.) (Not including FPC floating)

Note 1. Angular deviation of LCD cell from the TFT-LCD monitor's reference axis shall be less than [±40' ].

Note 2. Recommended FPC connectors  
For LCD : HIROSE, part number: FH23-39S-0.3SHW(05)

Note 3. Protective film is affixed on front surface of the screen.  
Location tolerance of the protective film shall be ±1.5 mm to the polarizing film.

Note 4. In case TFT-LCD monitor is fixed to the case of your product, it's recommended that monitor is fixed in to [hatched] area.  
If the burden on [hatched] area are smaller than [hatched] area, these area can be used too.  
Please choose a size implement the test.

Note 5. Refer to "15. CRITERIA OF JUDGMENT" about the appearance specification of a polarizer.

I-TAPE	7			t=0.05
S CASE C	6		SUS304	
S CASE A	5		SUS304	
FPC B	4			Use for LED
FPC A	3			Use for LCD
FRAME	2		PC	
LCD	1			Glass substrate thickness=0.5t
PART NAME	ITEM	PART CODE	MODEL NUMBER	REMARK

APPROVED 木下大輔	GENERAL TOLERANCE ±0.5	SCALE Free	UNIT mm
CHECKED 加藤真一	ISSUE (Y:M:D) 23:04:24	MODEL COM27H2P86U**	
CHECKED	NAME		
DESIGN 富田恵太			
DRAW 富田恵太			

<b>TOPPAN</b> TOPPAN INC.			
DO NOT DUPLICATE, CONFIDENTIAL AND PROPRIETARY			
DRAWING No.	REV.	SHEET	DIV.
RJD603987D301	#	/	

OUTLINE-D2P86

### 3.3 Serial № print (S-print)

#### 3.3.1 Display Items

S-print indicates the least significant digit of manufacture year (1digit), manufacture month with below alphabet (1letter), model code (5characters), serial number (6digits).

#### \* Contents of Display

*	*	*****	*****
-	-	-----	-----
a	b	c	d

Contents of display				
a	The least significant digit of manufacture year			
b	Manufacture month	Jan-A Feb-B Mar-C Apr-D	May-E Jun-F Jul-G Aug-H	Sep-I Oct-J Nov-K Dec-L
c	Model code	27GXC (Made in Japan) 27GYC (Made in Malaysia)		
d	Serial number			

#### \* Example of indication of Serial № print (S-print)

- Made in Japan

2L27GXC000125

means "manufactured in December 2022, 2.7"GX type, C specifications, serial number 000125"

- Made in Malaysia

2L27GYC000125

means "manufactured in December 2022, 2.7" GY type, C specifications, serial number 000125"

#### 3.3.2 Location of Serial № print (S-print)

Refer to 3.2 "Outward Form".

#### 3.3.3 Others

Please note that it is likely to disappear with an organic solvent about the Serial print.

## 4. Pin Assignment

No.	Symbol	Functions	IO
1	VSS	Ground	P
2	VSS	Ground	P
3	VDD	Power supply	P
4	VDD	Power supply	P
5	VSS	Ground	P
6	RESETB	Reset signal. When RESETB is Lo, an internal reset is performed.	I
7	HSYNC	Horizontal sync signal input. (Low active)	I
8	VSYNC	Vertical sync signal input. (Low active)	I
9	CLK	Clock signal for data latching and internal counter of the timing controller	I
10	VSS	Ground	P
11	D00	Display data(B) 00h: Black D00:LSB D05:MSB Driver has internal gamma conversion.	I
12	D01		I
13	D02		I
14	D03		I
15	D04		I
16	D05		I
17	D10	Display data(G) 00h: Black D10:LSB D15:MSB Driver has internal gamma conversion.	I
18	D11		I
19	D12		I
20	D13		I
21	D14		I
22	D15		I
23	D20	Display data(R) 00h: Black D20:LSB D25:MSB Driver has internal gamma conversion.	I
24	D21		I
25	D22		I
26	D23		I
27	D24		I
28	D25		I
29	VSS	Ground	P
30	DE	Input data effective signal. (It is effective for the period of "H")	I
31	STBYB	Standby signal (Lo:Standby operation,Hi:Normal operation)	I
32	TEST1	Connect to Ground.	I
33	NC	Open	-
34	NC	Open	-
35	NC	Open	-
36	NC	Open	-
37	TEST2	Connect to Ground.	I
38	BLH	LED drive power source (Anode side)	P
39	BLL	LED drive power source (Cathode side)	P

- Recommended connector: HIROSE ELECTRIC FH23 series [FH23-39S-0.3SHW(05)]
- Please refer to the section "3.2 Outward Form" for pin assignment.
- Since FPC cable has gold plated terminals, gilt finish contact shoe connector is recommended.



## 5. Absolute Maximum Rating

VSS=0V

Item	Symbol	Condition	Rating		Unit	Applicable terminal
			MIN	MAX		
Supply voltage	VDD		-0.3	4.6	V	VDD
Input voltage for logic	VI		-0.3	VDD+0.3	V	CLK, VSYNC, HSYNC, DE D[05:00], D[15:10], D[25:20] STBYB, RESETB TEST1, TEST2
LED forward current	IL	Ta = 25 °C	—	35	mA	BLH - BLL
		Ta = 70 °C	—	15		
Storage temperature range	Tstg		-30	80	°C	
Storage humidity range	Hstg	Non condensing in an environmental moisture at or less than 40 °C 90%RH			%	

## 6. Recommended Operating Conditions

VSS=0V

Item	Symbol	Condition	Rating			Unit	Applicable terminal
			MIN	TYP	MAX		
Supply voltage	VDD		2.7	3.0	3.6	V	VDD
Input voltage for logic	VI		0	—	VDD	V	CLK, VSYNC, HSYNC DE, D[05:00] D[15:10], D[25:20] STBYB, RESETB TEST1, TEST2
Operational temperature range Note 1	Top	Note 1, 2	-20	+25	+70	°C	Surface of panel
Operating humidity range	Hop	Ta ≤ 40 °C	20	—	85	%	
		Ta > 40 °C	Non condensing in an environmental moisture at or less than 40 °C 85%RH.				

Note 1: This monitor is operable in this temperature range. With regard to optical characteristics, refer to Item "14. Characteristics".

Note 2: Acceptable Forward Current to LED is up to 15mA, when Ta=+70 °C.  
Do not exceed Allowable Forward Current shown on the chart below.

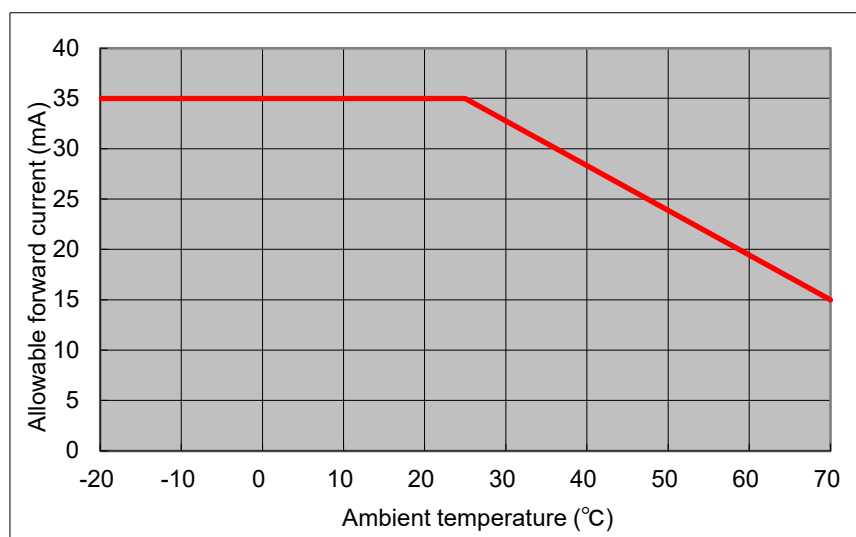

## 7. Electrical Characteristics



## 7.1 DC Characteristics

## 7.1.1 Display Module

(Unless otherwise noted,  $T_a=25^\circ\text{C}$ ,  $V_{DD}=3.0\text{V}$ ,  $V_{SS}=0\text{V}$ )

Item	Symbol	Condition	Rating			Unit	Applicable terminals
			MIN	TYP	MAX		
Input voltage for logic	$V_{IH}$		$0.7 \times V_{DD}$	—	$V_{DD}$	V	CLK, VSYNC, HSYNC DE, STBYB, RESETB
	$V_{IL}$		0	—	$0.3 \times V_{DD}$	V	D[05:00], D[15:10], D[25:20] TEST1, TEST2
Operating Current	$I_{DD}$	fCLK=5.6MHz Color bar display	—	6.5	13.0	mA	VDD

## 7.1.2 Backlight

Item	Symbol	Condition	Rating			Unit	Applicable terminal
			MIN	TYP	MAX		
Forward current	IL25	$T_a=25^\circ\text{C}$	—	7.0	35.0	mA	BLH - BLL  (Reference Value)
	IL70	$T_a=70^\circ\text{C}$	—	—	15.0	mA	
Forward voltage	VL	$T_a=25^\circ\text{C}$ , $I_L=7.0\text{mA}$	—	8.0	8.5	V	
Estimated Life of LED	LL	$T_a=25^\circ\text{C}$ , $I_L=7.0\text{mA}$ Note1	—	50,000	—	hrs	

Note1: - The lifetime of the LED is defined as a period till the brightness of the LED decreases to the half of its initial value.

- This figure is given as a reference purpose only, and not as a guarantee.
  - This figure is estimated for an LED operating alone.
- As the performance of an LED may differ when assembled as a monitor.
- Estimated lifetime could vary on a different temperature and usually higher temperature could reduce the life significantly.

## 7.2 AC Characteristics

(Unless otherwise noted,  $T_a=25^\circ\text{C}$ ,  $V_{DD}=3.0\text{V}$ ,  $V_{SS}=0\text{V}$ )

Item	Symbol	Condition	Rating			Unit	Applicable terminal
			MIN	TYP	MAX		
Clock frequency	fCLK		4.4	5.6	7.0	MHz	CLK
Clock Low period	tw1L	$0.3 \times V_{DD}$ or less	60	—	—	ns	CLK
Clock High period	tw1H	$0.7 \times V_{DD}$ or more	60	—	—	ns	CLK
VSYNC, HSYNC setup time	tsyncs		30	—	—	ns	CLK, VSYNC, HSYNC
DE setup time	tdes		25	—	—	ns	CLK, DE
DE hold time	tdeh		25	—	—	ns	
INPUT setup time	tsp		50	—	—	ns	CLK, D[05:00], D[15:10] D[25:20]
INPUT hold time	thd		50	—	—	ns	
Signal rising time	tr		—	—	15	ns	CLK, VSYNC, HSYNC
Signal falling time	tf		—	—	15	ns	DE, D[05:00], D[15:10] D[25:20]

Signal rising, falling time

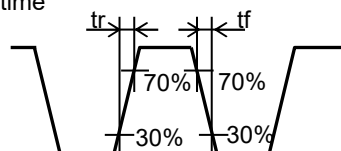



### 8. Switching Waveform Characteristics

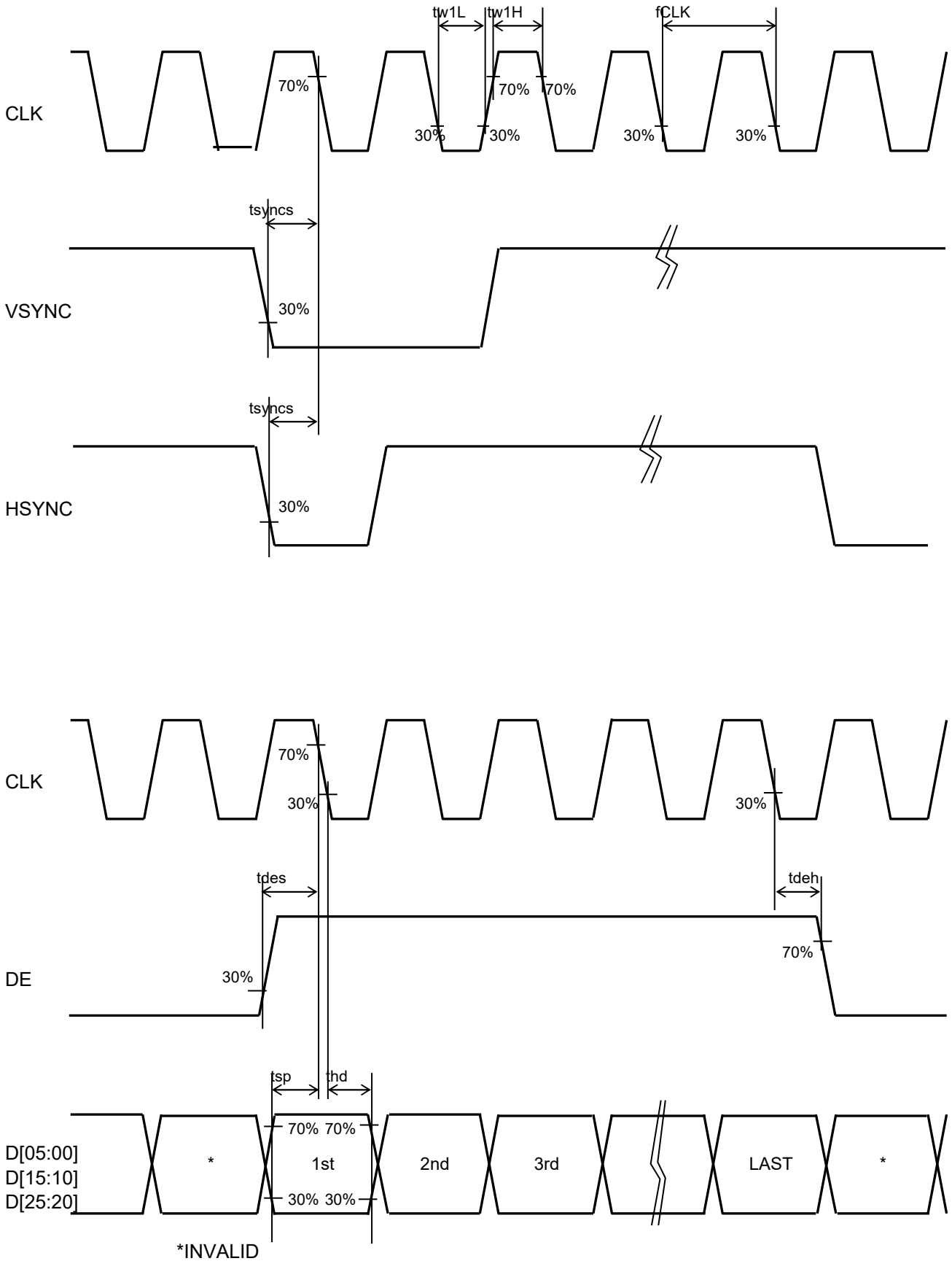

## 9. Input Timing

 9.1 Input Timing Characteristics

(Unless otherwise noted, Ta=25 °C,VDD=3.0V,VSS=0V)

Item	Symbol	Rating			Unit	Applicable terminals
		MIN	TYP	MAX		
CLK frequency	fCLK	4.4	5.6	7.0	MHz	CLK
VSYNC frequency	Note1 fVSYNC	54	60	66	Hz	VSYNC
VSYNC signal cycle time	tv	326	326	—	H	VSYNC,HSYNC
VSYNC pulse width	tw2H	2	2	tvb-2	H	VSYNC,HSYNC
Vertical back porch	tvb	4	4	127	H	VSYNC,HSYNC,DE D[05:00],D[15:10],D[25:20]
Vertical front porch	tvf	2	2	—	H	VSYNC,HSYNC,DE D[05:00],D[15:10],D[25:20]
Vertical display period	tvdp	—	320	—	H	VSYNC,HSYNC,DE D[05:00],D[15:10],D[25:20]
HSYNC frequency	fHSYNC	—	19.5	—	kHz	HSYNC
HSYNC signal cycle time	th	262	287	—	CLK	HSYNC,CLK
HSYNC pulse width	tw3H	2	2	thb-4	CLK	HSYNC,CLK
Horizontal back porch	thb	20	20	31	CLK	CLK,HSYNC,DE D[05:00],D[15:10],D[25:20]
Horizontal front porch	thf	2	27	—	CLK	CLK,HSYNC,DE D[05:00],D[15:10],D[25:20]
DE pulse width	tw4H	—	240	—	CLK	DE,CLK
Horizontal display period	thdp	—	240	—	CLK	CLK D[05:00],D[15:10],D[25:20]

Note: This is recommended spec to get high quality picture on display. It is customer's risk to use out of this frequency.

### 9.2 Driving Timing Chart

#### I. Vertical Timing

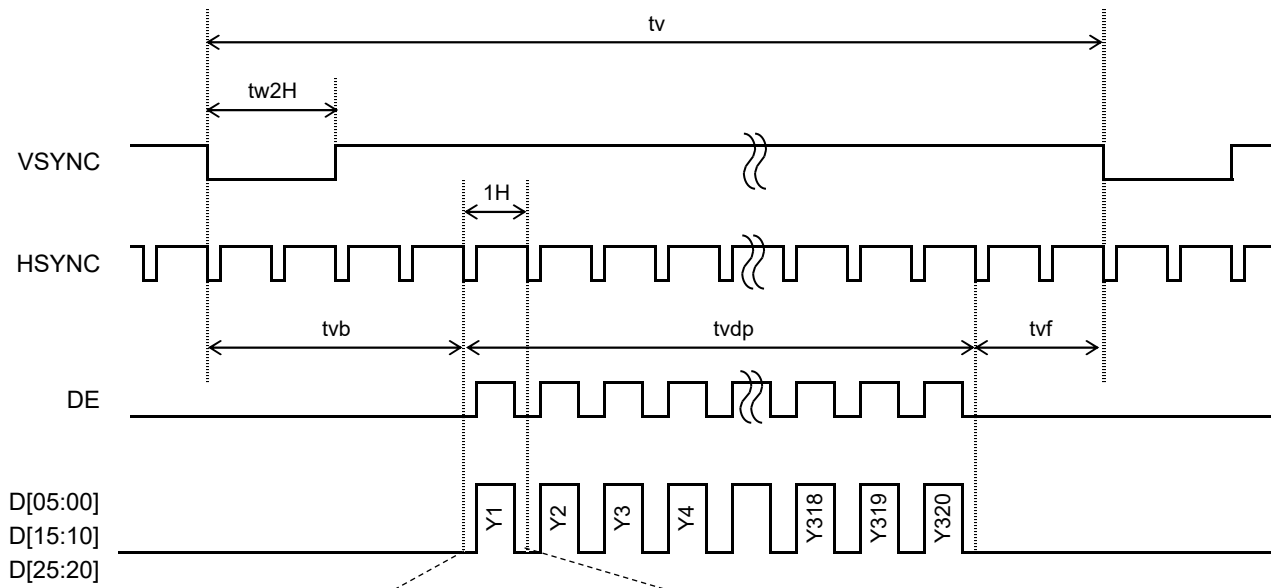

#### II. Horizontal Timing

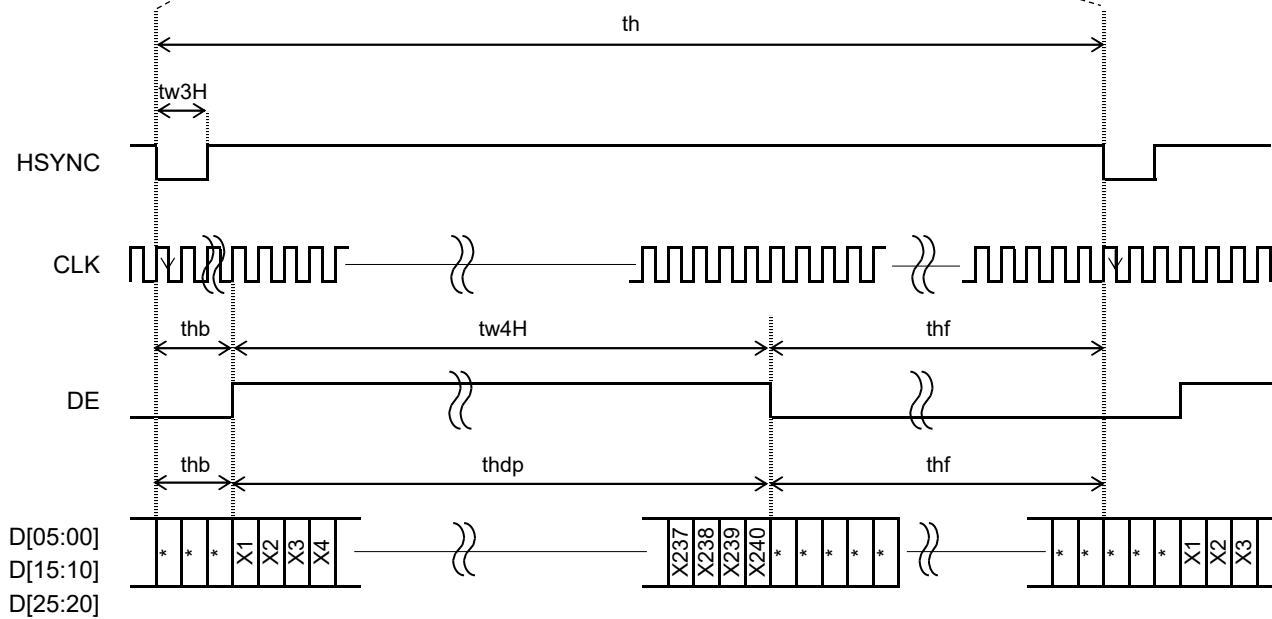



### 9.3 Example of Driving Timing Chart (fCLK=5.6MHz)

#### I. Vertical Timing

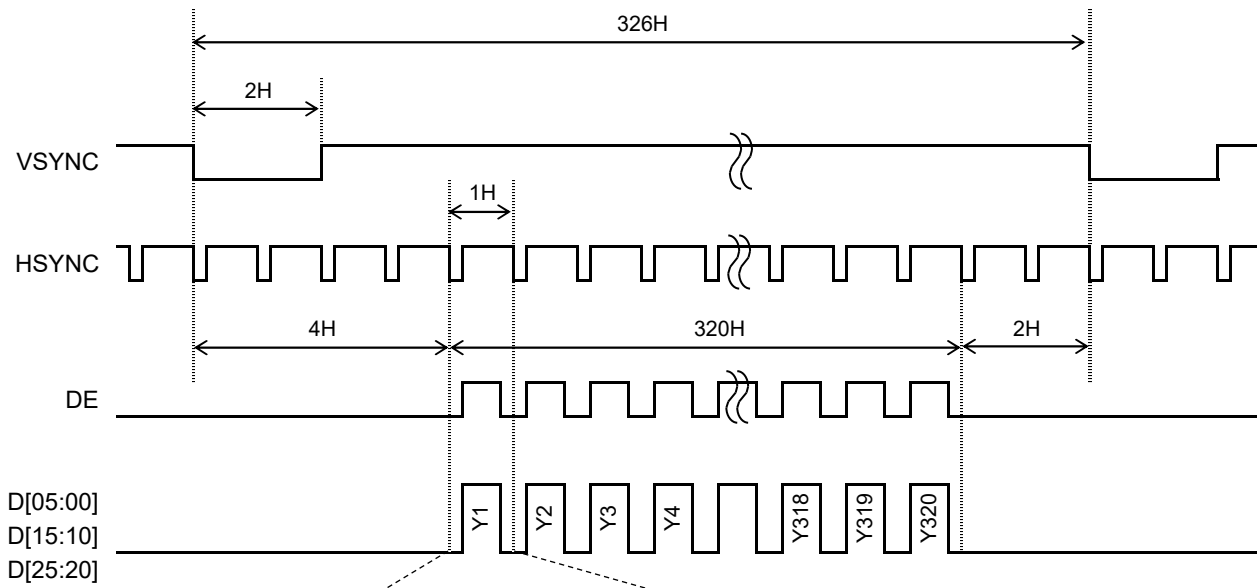

#### II. Horizontal Timing

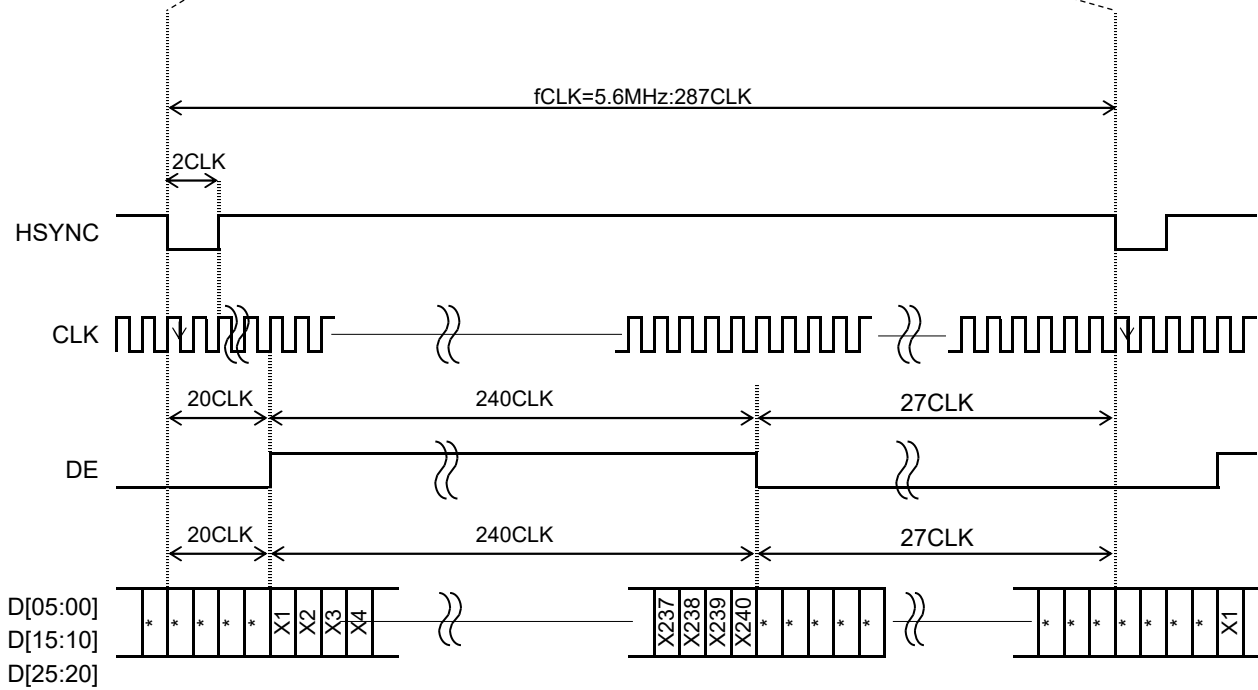

## 10. Power ON/OFF sequence

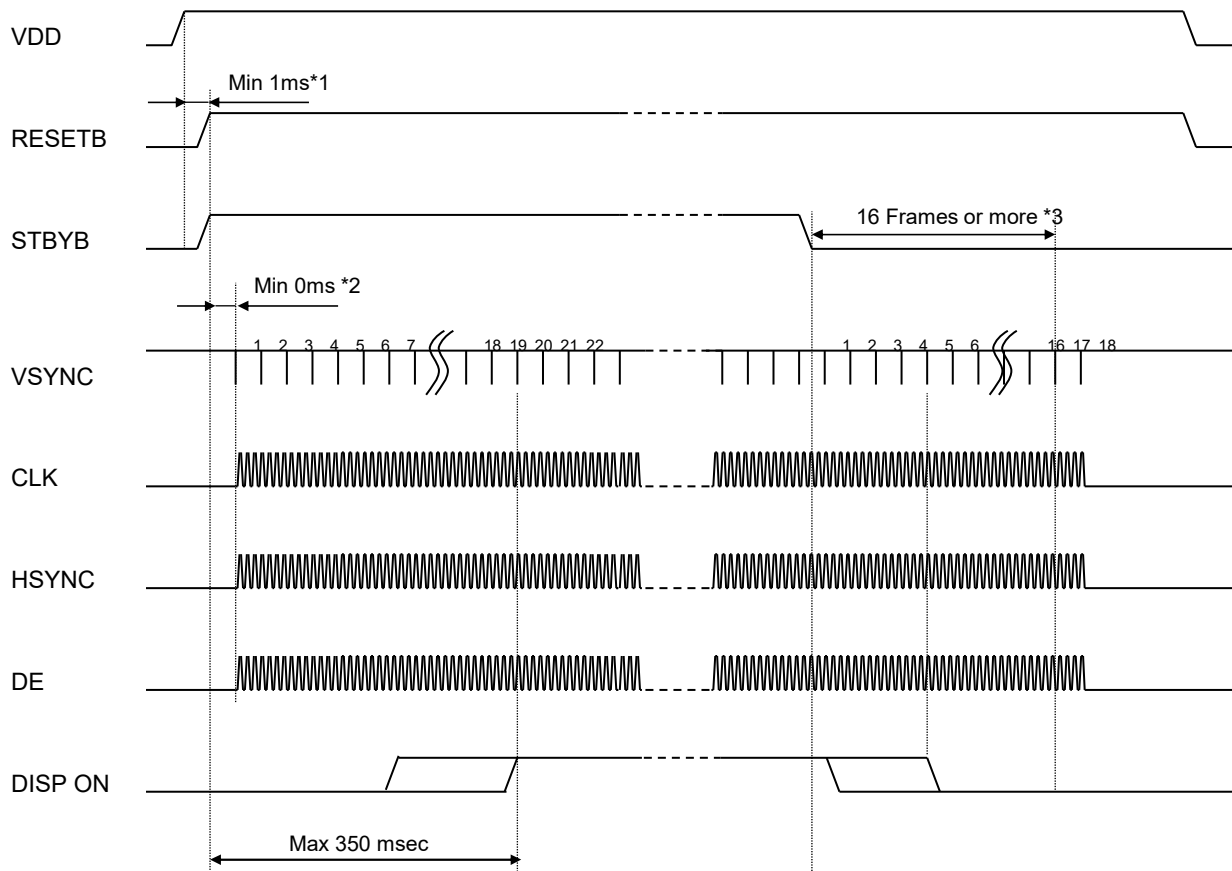

\*1 After the power supply, Please execute RESETB. (12. Reset sequence Reference)

\*2 There is no regulations at time until each signal is supplied from RESETB "H"  
But meanwhile, It is necessary to fix each signal to "H" or "L".

\*3 It is necessary to supply VSYNC and CLK(DOTCLK) for 16 frames or more from STBYB "L" to turning off the power supply without leaving the afterimage.

### 11. Display ON/OFF sequence

It explains the display sequence when display ON/OFF by the STBYB signal.

The following time will be needed by the time the displays begun from the standby release.

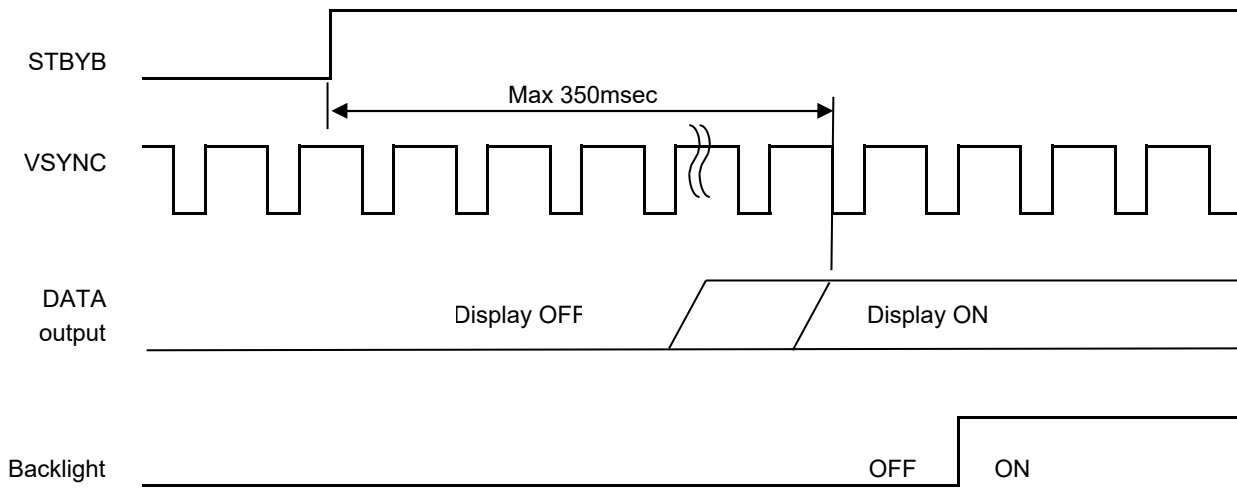

The following time will be needed by the time the standby sequence is ended from the standby setting.

Meanwhile, DOTCLK and the VSYNC signal should keep being supplied.

When DOTCLK and the VSYNC signal are stopped or the power supply is turned off to a regulated frame or less, the afterimage might remain.

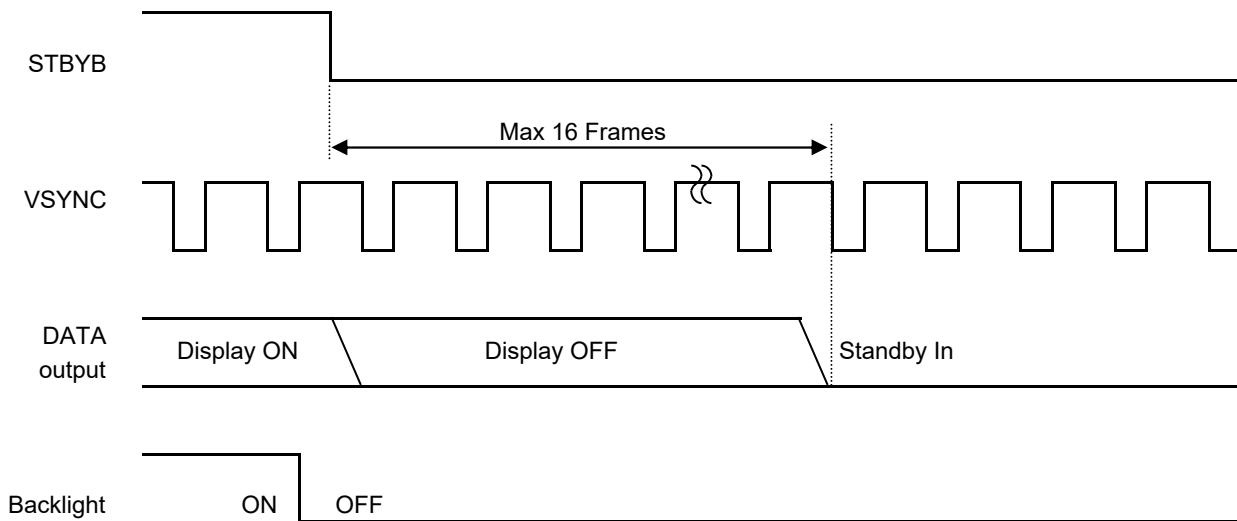

### 12. Reset sequence

There is a limitation between the power supply turning on and the RESETB input.

Please defend the following conditions.

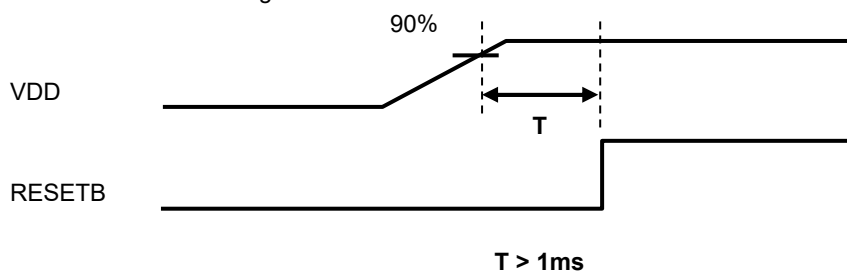

13. LED Circuit

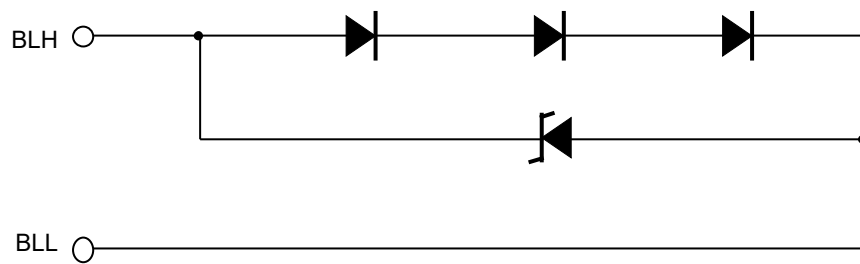

## 14. Characteristics

## 14.1 Optical Characteristics

(Measurement Condition)

Measuring instruments: CS2000 (KONICA MINOLTA), LCD7200 (OTSUKA ELECTRONICS), EZcontrastXL88 (ELDIM)

Driving condition: VDD = 3.0V, VSS = 0V, Optimized VCOMDC

Backlight: IL= 7.0 mA

Measured temperature: Ta = 25°C

Item		Symbol	Condition	MIN	TYP	MAX	Unit	Note №	Remark
Response time	Rise time	TON	[Data]= 00h ← → 3Fh	-	-	100	ms	1	
	+ Fall time	TOFF							
Contrast ratio	Backlight ON	CR	[Data]= 3Fh / 00h	400	800	-		2	
	Backlight OFF			-	2	-			
Viewing angle	Left	$\theta L$	[Data]= 3Fh / 00h CR $\geq$ 10	80	-	-	deg	3	
	Right	$\theta R$		80	-	-	deg		
	Up	$\varphi U$		80	-	-	deg		
	Down	$\varphi D$		80	-	-	deg		
White Chromaticity		x y	[Data]= 3Fh	White chromaticity range				4	
Center Brightness			[Data]= 3Fh	240	350	-	cd/m <sup>2</sup>	5	
Brightness distribution			[Data]= 3Fh	70	-	-	%	6	
Burn-in				No noticeable burn-in image shall be observed after 2 hours of window pattern display.				7	

\* Note number 1 to 7: Refer to the APPENDIX of "Reference Method for Measuring Optical Characteristics and Performance".

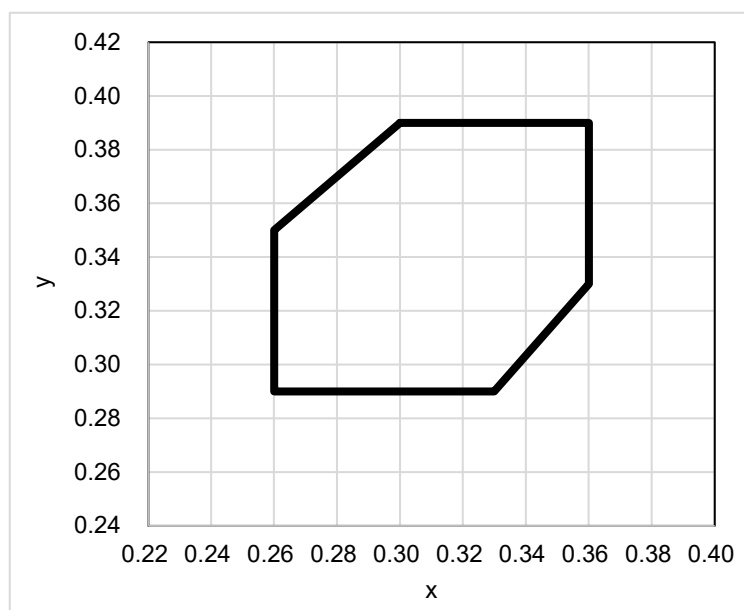

White Chromaticity Range

(White Chromaticity Range)

x	y
0.30	0.39
0.26	0.35
0.26	0.29
0.33	0.29
0.36	0.33
0.36	0.39

## 14.2 Temperature Characteristics

(Measurement Condition)

Measuring instruments: CS2000 (KONICA MINOLTA), LCD7200 (OTSUKA ELECTRONICS)

Driving condition: VDD = 3.0V, VSS = 0V, Optimized VCOMDC

Backlight: IL= 7.0 mA

Item		Symbol	Specification		Remark
			Ta = -20 °C	Ta = 70 °C	
Response time	Rise time + Fall time	TON + TOFF	1000 msec or less	80 msec or less	
Contrast ratio		CR	200 or more	200 or more	Backlight ON
Display Quality			No noticeable display defect or ununiformity should be observed.		

## 15. Criteria of Judgment

**A** 15.1 Defective Display and Screen Quality

Test Condition: Observed TFT-LCD monitor from front during operation with the following conditions

Driving Signal: Raster Patter (RGB, white, black)

Signal condition: [Data]:00h, 28h, 3Fh (3steps)

Observation distance: 30 cm

Illuminance: 200 to 350 lx

Backlight: IL=7.0mA

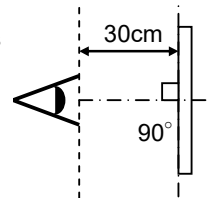

Defect item	Defect content	Criteria		
Display Quality	Line defect	Black, white or color line, 3 or more neighboring defective dots	Not exists	
	Dot defect	Uneven brightness on dot-by-dot base due to defective TFT or CF, or dust is counted as dot defect (brighter dot, darker dot)	Refer to table 1	
		High bright dot: Visible through 2% ND filter at [Data]=00h	Acceptable	
		Low bright dot: Visible through 5% ND filter at [Data]=00h		
	Dark dot: Appear dark through white display at [Data]=28h			
	Invisible through 5% ND filter at [Data]=00h	Acceptable		
Screen Quality	Stain	Uneven brightness (white stain, black stain etc)	Invisible through 5% ND filter at Black screen. Invisible through 1% ND filter at other screen.	
	Foreign particle	Point-like	$0.25\text{mm} < \varphi$	N=0
			$0.20\text{mm} < \varphi \leq 0.25\text{mm}$	$N \leq 2$
			$\varphi \leq 0.20\text{mm}$	Acceptable
	Liner	$3.0\text{mm} < \text{length and } 0.08\text{mm} < \text{width}$	N=0	
$\text{length} \leq 3.0\text{mm}$ or $\text{width} \leq 0.08\text{mm}$		Acceptable		
Others		Use boundary sample for judgment when necessary		

$\varphi$ (mm): Average diameter = (major axis + minor axis)/2  
Permissible number: N

Table1

Area	High bright dot	Low bright dot	Dark dot	Total	Criteria
A	0	2	2	3	Permissible distance between same color bright dots (includes neighboring dots): 3 mm or more Permissible distance between same color high bright dots (includes neighboring dots): 5 mm or more
B	2	4	4	5	
Total	2	4	4	5	

<Portrait model>

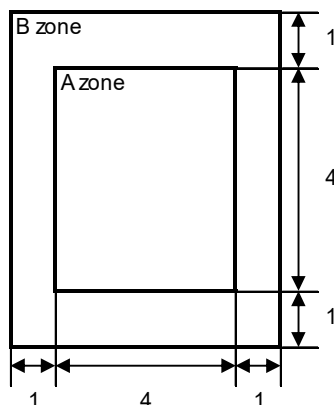

Division of A and B areas

B area: Active area

Dimensional ratio between A and B areas: 1: 4: 1

(Refer to the left figure)

## 15.2 Screen and Other Appearance

Testing conditions

Observation distance: 30 cm

Illuminance: 1200 ~ 2000 lx

Item		Criteria	Remark
Polarizer	Flaw	Ignore invisible defect when the backlight is on.	Applicable area: Active area only (Refer to the section 3.2 Outward Form)
	Stain		
	Dirt		
	Bubble		
	Dust		
	Dent		
S case		No functional defect occurs	
FPC		No functional defect occurs	



## 16. Reliability Test

Test item		Test condition	number of failures / number of examinations
Durability test	High temperature storage	Ta = 80°C 240hrs	0 / 3
	Low temperature storage	Ta = -30°C 240hrs	0 / 3
	High temperature & high humidity storage	Ta = 60°C, RH = 90%, non condensing ※	0 / 3
	High temperature operation	Tp = 70°C 240hrs	0 / 3
	Low temperature operation	Tp = -20°C 240hrs	0 / 3
	High temperature & high humidity operation	Tp = 40°C, RH = 90%, non condensing ※	0 / 3
	Thermal shock storage	-30°C ↔ 80°C (30min / 30min) 100cycles	0 / 3
	Lightfastness	Xenon Blackpanel 63±3°C non-shower 450W/m <sup>2</sup> (300~700nm) non-operating Integral dose 800MJ/m <sup>2</sup>	0 / 3
Mechanical environmental test	Electrostatic discharge test (Non operation)	Confirms to EIAJ ED-4701/300, C=200pF,R=0Ω,V=±200V Each 3 times of discharge on and power supply and other terminals.	0 / 3
	Surface discharge test (Non operation)	C=250pF, R=100Ω, V=±12kV Each 5 times of discharge in both polarities on the center of screen with the case grounded.	0 / 3
	Vibration test	Total amplitude 1.5mm, f=10~55Hz, X,Y,Z directions for each 2 hours	0 / 3
	Impact test	Use TOPPAN original jig (see next page) and make an impact with peak acceleration of 1000m/s <sup>2</sup> for 6 msec with half sine-curve at 3 times to each X, Y, Z directions in conformance with JIS C 60068-2-27-2011.	0 / 3
Packing test	Packing vibration-proof test	Acceleration of 19.6m/s <sup>2</sup> with frequency of 10→55→10Hz, X,Y, Zdirection for each 30 minutes.	0 / 1 packing
	Packing drop test	Drop from 75cm high. 1 time to each 6 surfaces, 3 edges, 1 corner	0 / 1 packing

Note:Ta=ambient temperature Tp=Panel temperature

※ The profile of high temperature/humidity storage and High Temperature/humidity operation (Pure water of over 10MΩ·cm shall be used.)

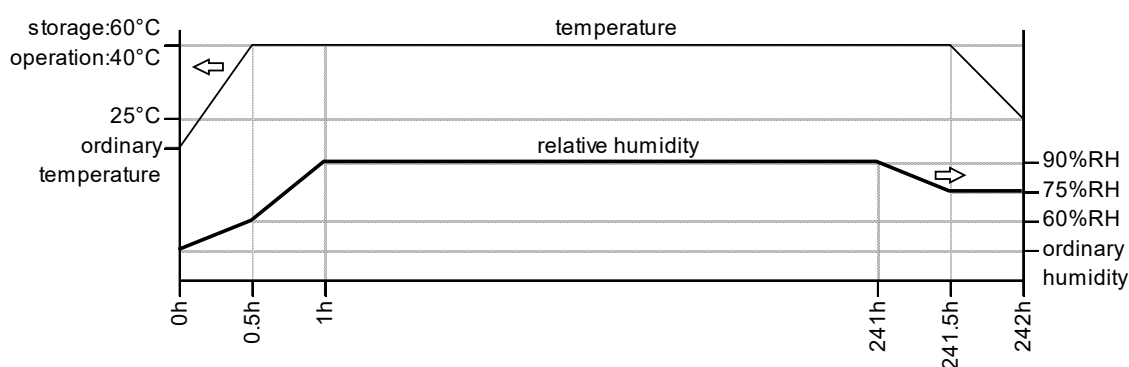
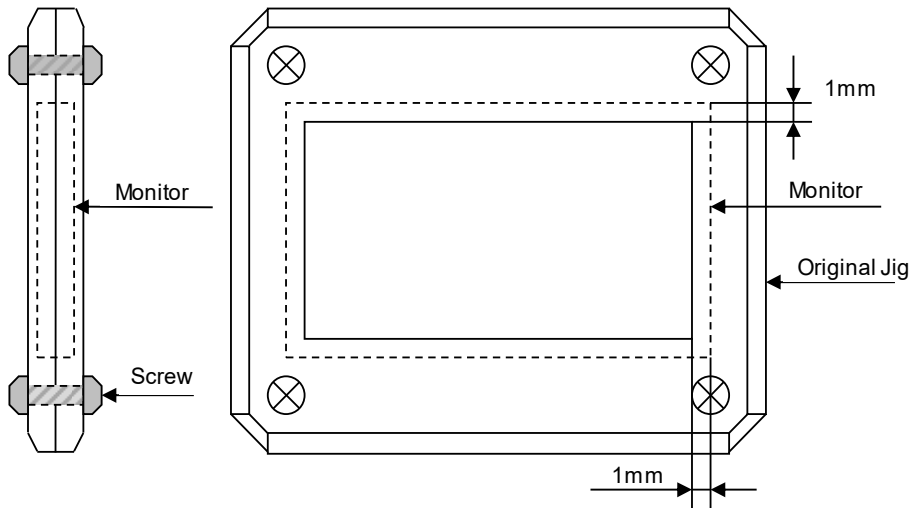

Table2. Reliability Criteria

The parameters should be measured after leaving the monitor at the ordinary temperature for 24 hours or more after the test completion.

Item	Standard	Remark
Display quality	No visible abnormality shall be seen. (Except for unevenness by PoI deterioration.)	
Contrast ratio	200 or more	Backlight ON

TOPPAN Original Jig



## 17. Packing Specifications

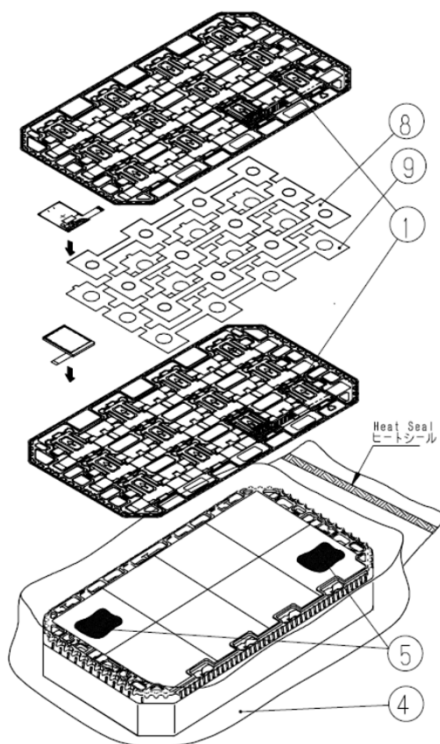

- Step 1. Each product is to be placed in one of the cut-outs of the tray with the display surface facing upward.  
Foam sheet A/B are to be placed on the products in the tray.  
Each product is to be placed in one of the cut-outs of the tray with the display surface facing downward.(24products per tray)
- Step 2. Each tray is to be piled up in same orientation and the trays be in a stack of 6.  
One empty tray is to be put on the top of stack of 6 trays.
- Step 3. 2 packs of moisture absorbers are to be placed on the top tray as shown in the drawing.  
Put piled trays into a sealing bag.
- Step 4. Vacuum and seal the sealing bag with the vacuum sealing machine.
- Step 5. The stack of trays in the plastic back is to be wrapped with B SHEET A.
- Step 6. The wrapped trays are placed in the carton.
- Step 7. B SHEET B are to be inserted into a outer carton with same orientation.  
The outer carton is to be sealed in H-shape with packing tape as shown in the drawing.
- Step 8. The model number, quantity of products, and shipping date are to be printed on the outer carton.  
If necessary, shipping labels or impression markings are to be put on the outer carton.

Remark: The return of packing materials is not required.

Packing item name	Specs., Material
① Tray	A-PET
② B SHEET A	Anti-static air bubble sheet
③ B SHEET B	Anti-static air bubble sheet
④ Sealing bag	
⑤ Drier	Moisture absorber
⑥ Packing tape	
⑦ Outer carton	Corrugated cardboard
⑧ FOAM SHEET A	Anti-static polyethylene
⑨ FOAM SHEET B	Anti-static polyethylene

Dimension of outer carton	
D : Approx.	( 337mm )
W : Approx.	( 618mm )
H : Approx.	( 179mm )
Quantity of products packed in one carton:	144
Gross weight : Approx.	5.2 kg

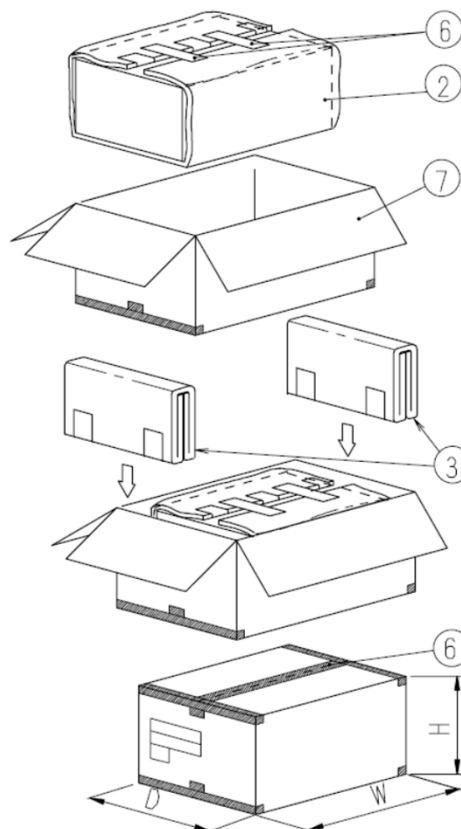

## 18. Handling Instruction

## 18.1 Cautions for Handling LCD panels

**Caution**

- (1) Do not make an impact on the LCD panel glass because it may break and you may get injured from it.
- (2) If the glass breaks, do not touch it with bare hands.  
(Fragment of broken glass may stick you or you cut yourself on it.)
- (3) If you get injured, receive adequate first aid and consult a medial doctor.
- (4) Do not let liquid crystal get into your mouth.  
(If the LCD panel glass breaks, try not let liquid crystal get into your mouth even toxic property of liquid crystal has not been confirmed.)
- (5) If liquid crystal adheres, rinse it out thoroughly.  
(If liquid crystal adheres to your cloth or skin, wipe it off with rubbing alcohol or wash it thoroughly with soap. If liquid crystal gets into eyes, rinse it with clean water for at least 15 minutes and consult an eye doctor.)
- (6) If you scrap this products, follow a disposal standard of industrial waste that is legally valid in the community, country or territory where you reside.
- (7) Do not connect or disconnect this product while its application products is powered on.
- (8) Do not attempt to disassemble or modify this product as it is precision component.
- (9) If a part of soldering part has been exposed, and avoid contact (short-circuit) with a metallic part of the case etc. about FPC of this model, please.  
Please insulate it with the insulating tape etc. if necessary.  
The defective operation is caused, and there is a possibility to generation of heat and the ignition.
- (10) Since excess current protection circuit is not built in this TFT module, there is the possibility that LCD module or peripheral circuit become feverish and burned in case abnormal operation is generated.  
We recommend you to add excess current protection circuit to power supply.
- (11) The devices on the FPC are damageable to electrostatic discharge, because the terminals of the devices are exposed.  
Wear grounded wrist-straps and use electrostatic neutralization blowers to prevent static charge and discharge when handling the TFT monitors.  
Designate an appropriate operating area, and set equipment, tools, and machines properly when handling this product.

**Caution**

This mark is used to indicate a precaution or an instruction which, if not correctly observed, may result in bodily injury, or material damages alone.

## 18.2 Precautions for Handling

- 1) Wear finger tips at incoming inspection and for handling the TFT monitors to keep display quality and keep the working area clean.  
Do not touch the surface of the monitor as it is easily scratched.
- 2) Wear grounded wrist-straps and use electrostatic neutralization blowers to prevent static charge and discharge when handling the TFT monitors as the LED in this TFT monitors is damageable to electrostatic discharge.  
Designate an appropriate operating area, and set equipment, tools, and machines properly when handling this product.
- 3) Avoid strong mechanical shock including knocking, hitting or dropping to the TFT monitors for protecting their glass parts.  
Do not use the TFT monitors that have been experienced dropping or strong mechanical shock.
- 4) Do not use or storage the TFT monitors at high temperature and high humidity environment.  
Particularly, never use or storage the TFT monitors at a location where condensation builds up.
- 5) Avoid using and storing TFT monitors at a location where they are exposed to direct sunlight or ultraviolet rays to prevent the LCD panels from deterioration by ultraviolet rays.
- 6) Do not stain or damage the contacts of the FPC cable .  
FPC cable needs to be inserted until it can reach to the end of connector slot.  
During insertion, make sure to keep the cable in a horizontal position to avoid an oblique insertion.  
Otherwise, it may cause poor contact or deteriorate reliability of the FPC cable.
- 7) The FPC cable is a design very weak to the bend and the pull as it is fixed with the tape.  
Do not bend or pull the FPC cable or carry the TFT monitor by holding the FPC cable.
- 8) Peel off the protective film on the TFT monitors during mounting process.  
Refer to the section 18.5 on how to peel off the protective film.  
We are not responsible for electrostatic discharge failures or other defects occur when peeling off the protective film.

## 18.3 Precautions for Operation

- 1) Since this TFT monitors are not equipped with light shielding for the driver IC,  
do not expose the driver IC to strong lights during operation as it may cause functional failures.
- 2) In case of powering up or powering off this LCD module,  
be sure to comply the sequence as instructed in this specification.
- 3) Do not plug in or out the FPC cable while power supply is switch on.  
Plug the FPC cable in and out while power supply is switched off.
- 4) Do not operate the TFT monitors in the strong magnetic field. It may break the TFT monitors.
- 5) Do not display a fixed image on the screen for a long time.  
Use a screen-saver or other measures to avoid a fixed image displayed on the screen for a long time.  
Otherwise, it may cause burn-in image on the screen due the characteristics of liquid crystal.

#### 18.4 Storage Condition for Shipping Cartons

(Storage environment)

- Temperature 0 to 40° C
- Humidity 60%RH or less  
No-condensing occurs under low temperature with high humidity condition.
- Atmosphere No poisonous gas that can erode electronic components and/or wiring materials should be detected.
- Time period 1 year
- Unpacking To prevent damages caused by static electricity, anti-static precautionary measures (e.g. earthing, anti-static mat) should be implemented.  
After unpack, keep product in the appropriate condition, otherwise bubble seal of Protective film may be printed on Polarizer.
- Maximum piling up 8 cartons (excluding the bottom)

\*Conditions to storage after unpacking

(Storage environment)

- Temperature 0 to 40° C
- Humidity 60%RH or less  
No-condensing occurs under low temperature with high humidity condition.
- Atmosphere No poisonous gas that can erode electronic components and/or wiring materials should be detected.
- Time period 1 year (Shelf life)
- Others Keep/ store away from direct sunlight  
Storage goods on original tray made by TOPPAN.

### 18.5 Precautions for Peeling off the Protective film

The followings work environment and work method are recommended to prevent the TFT monitors from static damage or adhesion of dust when peeling off the protective films.

#### A) Work Environment

- a) Humidity: 50 to 70 %RH, Temperature 15 to 27 ° C
- b) Operators should wear conductive shoes, conductive clothes, conductive finger tips and grounded wrist-straps.  
Use an electrostatic neutralization blower.
- c) Anti-static treatment should be implemented to work area's floor.  
Use a room shielded against outside dust with sticky floor mat laid at the entrance to eliminate dirt.

#### B) Work Method

The following procedures should taken to prevent the driver ICs from charging and discharging.

- a) Use an electrostatic neutralization blower to blow air on the TFT monitors to its lower left when FPC is placed at the left.  
Optimize direction of the blowing air and the distance between the TFT monitors and the electrostatic neutralization blower.
- b) Put an adhesive tape (Scotch tape, etc) at the lower left corner area of the protective film to prevent scratch on surface of TFT monitors.
- c) Peel off the adhesive tape slowly (spending more than 2 secs to complete) by pulling it to opposite direction.

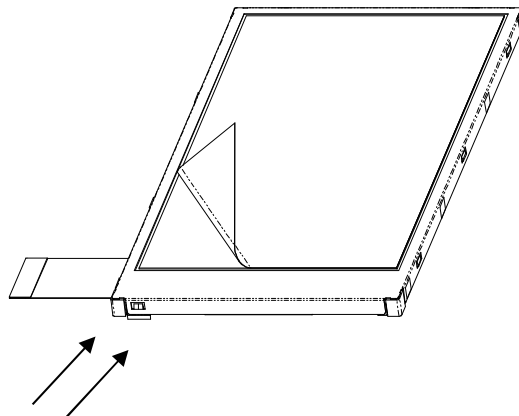

Blower wind direction  
(Set an ion blower with its adequate conditions.)

### 18.6 Warranty

TOPPAN is only liable to defective goods which is stored and used under the condition complying with this specifications and returned within 1 (one) year.

Warranty caused by manufacturing defect shall be conducted by replacement of goods or refundment at unit price.

**APPENDIX**

Reference Method for Measuring Optical Characteristics and Performance

1. Measurement Condition (Backlight ON)

Measuring instruments: CS2000 (KONICA MINOLTA), LCD7200 (OTSUKA ELECTRONICS), EZcontrastXL88 (ELDIM)

Driving condition: Refer to the section "Optical Characteristics"

Measured temperature: 25°C unless specified

Measurement system: See the chart below. The luminance meter is placed on the normal line of measurement system.

Measurement point: At the center of the screen unless otherwise specified

Dark box at constant temperature

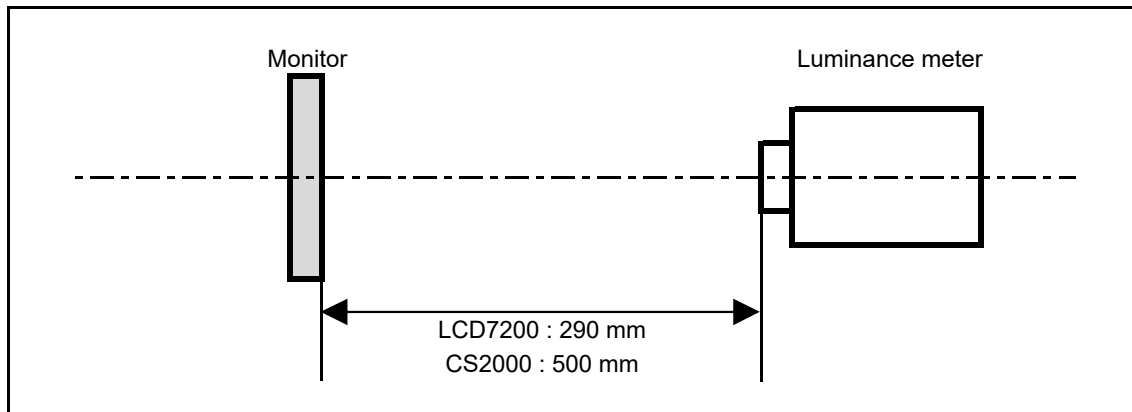

\*Measurement is made after 30 minutes of lighting of the backlight.

Measurement point: At the center point of the screen

Brightness distribution: 9 points shown in the following drawing.

<Portrait model>

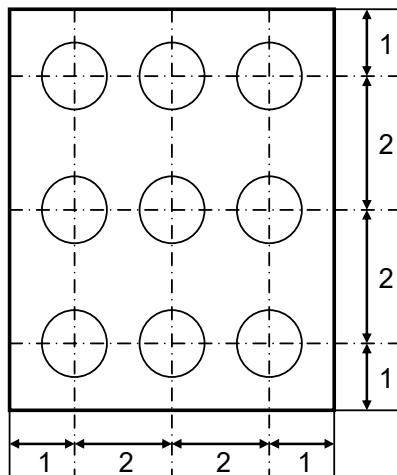

Dimensional ratio of active area

Backlight IL=7.0mA

Measurement Condition (Contrast ratio Backlight OFF only)

Measuring instruments: LCD7200(OTSUKA ELECTRONICS) , Ring Light (40,000 lx,  $\phi 58$ )

Driving condition: Refer to the section "Optical Characteristics"

Measured temperature: 25°C unless specified

Measurement system: See the chart below.

Measurement point: At the center of the screen unless otherwise specified

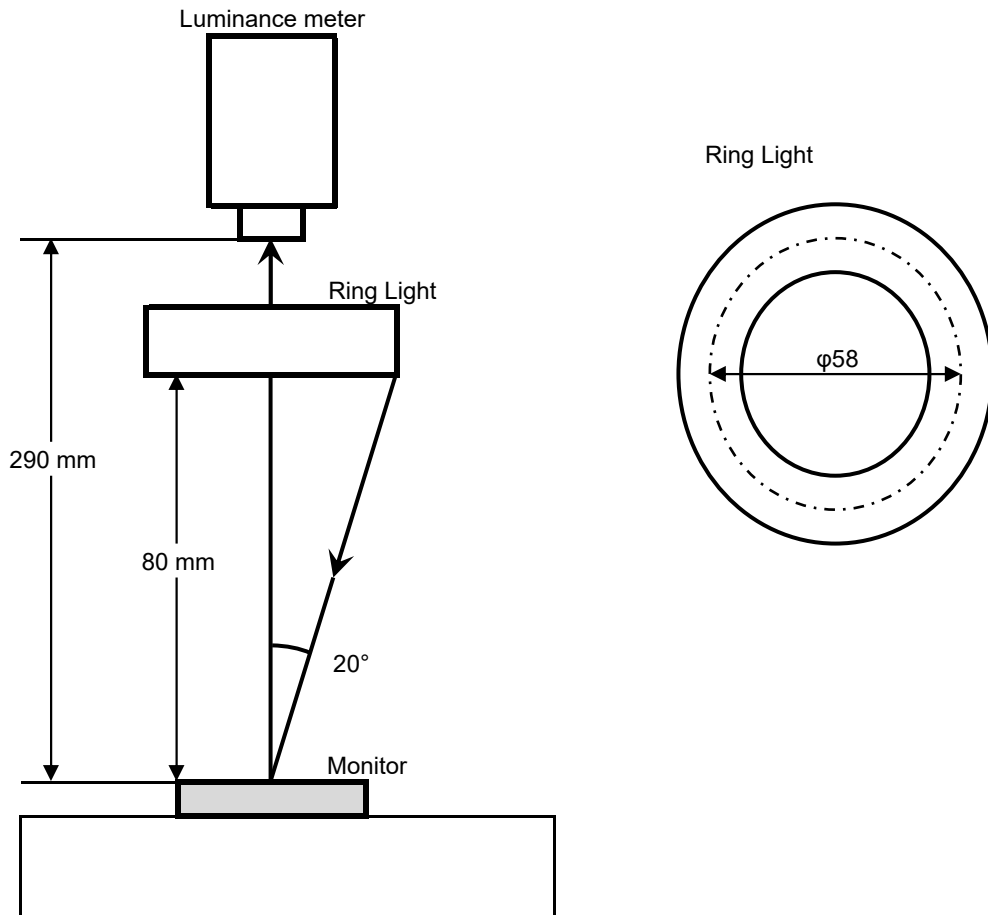

## 2. Test Method

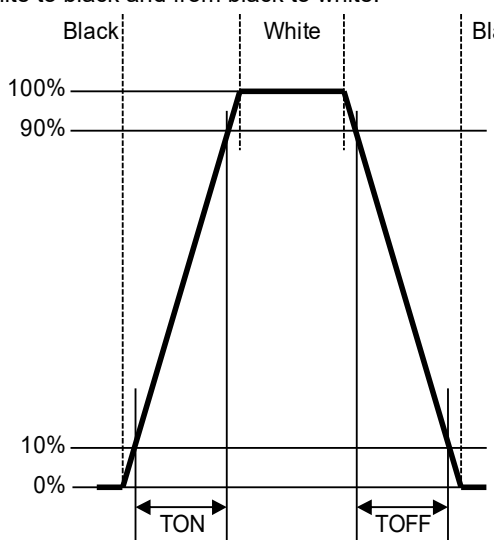
Notice	Item	Test method	Measuring instrument	Remark
1	Response time	Measure output signal waveform by the luminance meter when raster of window pattern is changed from white to black and from black to white. 	LCD7200	Black display [Data]=00h White display [Data]=3Fh TON Rise time TOFF Fall time
2	Contrast ratio	Measure maximum luminance Y1([Data]=3Fh) and minimum luminance Y2([Data]=00h) at the center of the screen by displaying raster or window pattern. Then calculate the ratio between these two values. $\text{Contrast ratio} = Y1/Y2$ Diameter of measuring point: 7.8mmφ(CS2000) Diameter of measuring point: 3mmφ(LCD7200)	CS2000 LCD7200	Backlight ON Backlight OFF
3	Viewing angle Horizontalθ Verticalφ	Move the luminance meter from right to left and up and down and determine the angles where contrast ratio is 10.	EZcontrastXL88	
4	White chromaticity	Measure chromaticity coordinates x and y of CIE1931 colorimetric system at [Data] = 3Fh Color matching function: 2°view measurement angle: 1°	CS2000	
5	Center brightness	Measure the brightness at the center of the screen.	CS2000	
6	Brightness distribution	$(\text{Brightness distribution}) = 100 \times B/A \%$ A : max. brightness of the 9 points B : min. brightness of the 9 points	CS2000	
7	Burn-in	Visually check burn-in image on the screen after 2 hours of "window display" ([Data]=00h/3Fh).		At optimized VCOMDC