

SOT -23 Plastic-Encapsulate MOSFETS

$V_{(BR)DSS}$	$R_{DS(on)MAX}$	I_D
20V	55 mΩ@ 4.5V	3A
	85 mΩ@ 2.5V	

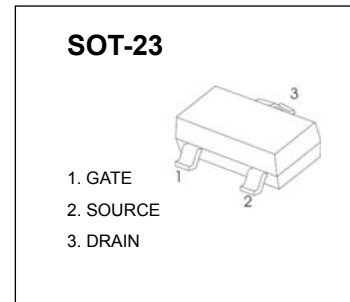

FEATURE

- TrenchFET Power MOSFET

APPLICATION

- Load Switch for Portable Devices
- DC/DC Converter

MARKING

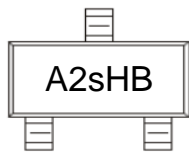

Equivalent Circuit

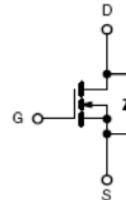

Maximum ratings ($T_a=25^{\circ}C$ unless otherwise noted)

Parameter	Symbol	Value	Unit
Drain-Source Voltage	V_{DS}	20	V
Gate-Source Voltage	V_{GS}	±12	
Continuous Drain Current	I_D	3	A
Pulsed Drain Current	I_{DM}	10	
Continuous Source-Drain Current(Diode Conduction)	I_S	1	
Maximum Power Dissipation	P_D	1.25	W
Thermal Resistance from Junction to Ambient($t \leq 5s$)	$R_{\theta JA}$	100	$^{\circ}C/W$
Junction Temperature	T_J	150	$^{\circ}C$
Storage Temperature	T_{stg}	-55~+150	

MOSFET ELECTRICAL CHARACTERISTICS
T_a=25 °C unless otherwise specified

Parameter	Symbol	Test Condition	Min	Typ	Max	Units
Static						
Drain-source breakdown voltage	V _{(BR)DSS}	V _{GS} = 0V, I _D = 250μA	20	21.5		V
Gate-source threshold voltage	V _{GS(th)}	V _{DS} = V _{GS} , I _D = 250μA	0.4	0.7	1	
Gate-source leakage	I _{GSS}	V _{DS} = 0V, V _{GS} = ±12V			±100	nA
Zero gate voltage drain current	I _{DSS}	V _{DS} = 20V, V _{GS} = 0V			1	μA
Drain-source on-state resistance ^a	R _{DS(on)}	V _{GS} = 4.5V, I _D = 3.0A		45	55	mΩ
		V _{GS} = 2.5V, I _D = 2.0A		63	85	
Forward transconductance ^a	g _{fs}	V _{DS} = 5V, I _D = 3.6A		8		S
Dynamic ^b						
Input capacitance	C _{iss}	V _{DS} = 10V, V _{GS} = 0V, f = 1MHz		300		pF
Output capacitance	C _{oss}			120		
Reverse transfer capacitance	C _{rss}			80		
Switching characteristics(note4)						
Turn-on delay time	t _{d(on)}	V _{GS} = 10V, V _{GEN} = 4.5V R _L = 5.5Ω, R _g = 6Ω			15	ns
Rise time	t _r				80	
Turn-off delay time	t _{d(off)}				60	
Fall time	t _f				25	
Drain-source body diode characteristics						
Body diode voltage (note3)	V _{SD}	I _S = 1A		0.8	1.0	V

Notes :

- a. Pulse Test : Pulse width < 300us, duty cycle < 2%.
- b. These parameters have no way to verify.

Output Characteristics

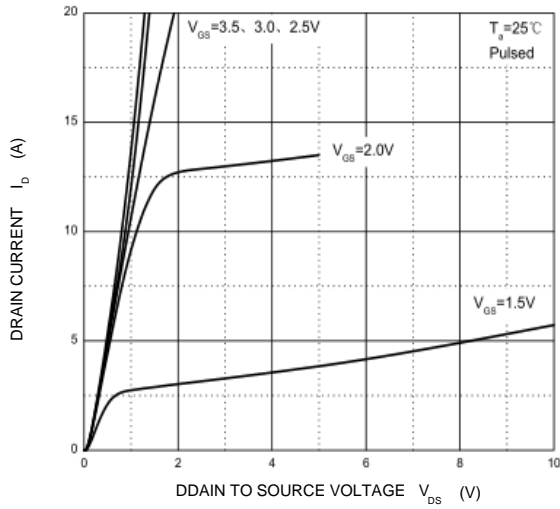

Transfer Characteristics

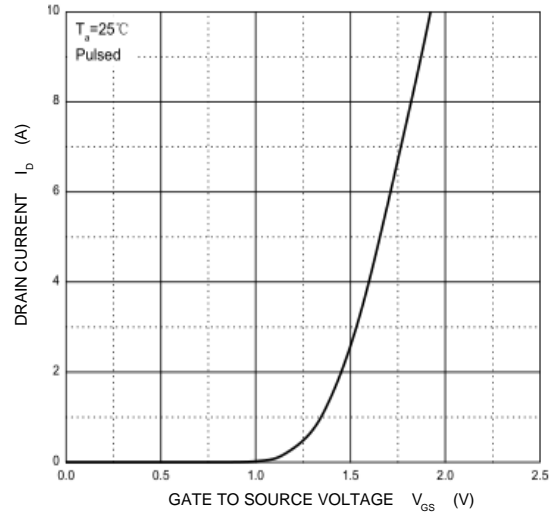

$R_{DS(ON)}$ — I_D

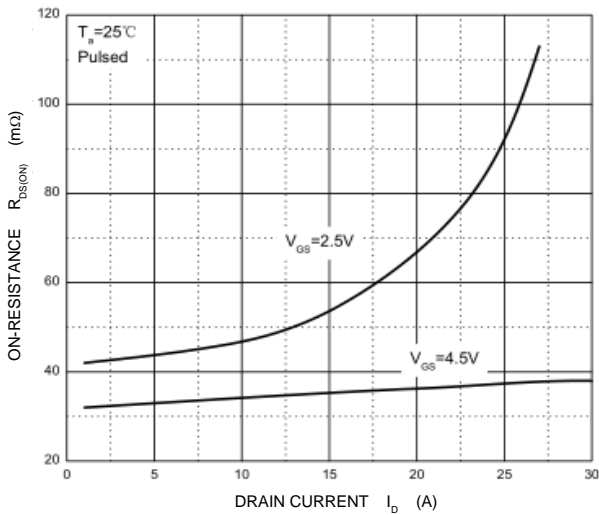

$R_{DS(ON)}$ — V_{GS}

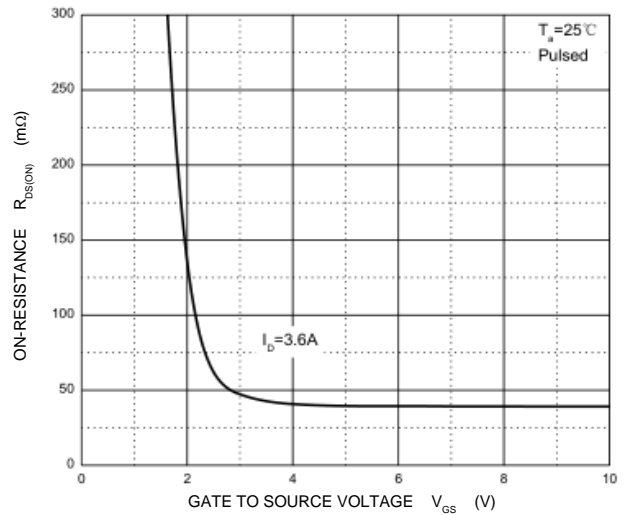

I_S — V_{SD}

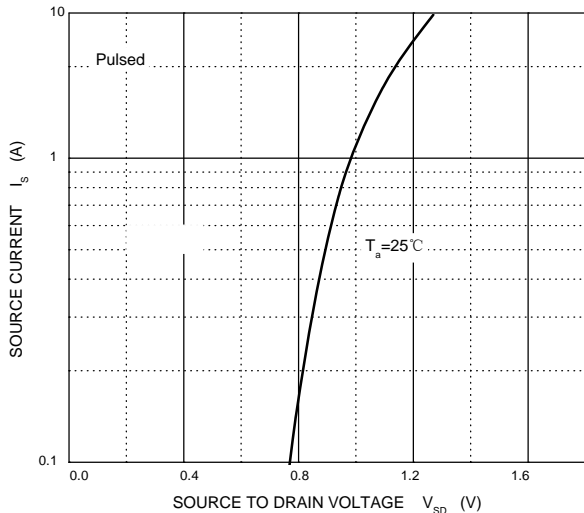

Threshold Voltage

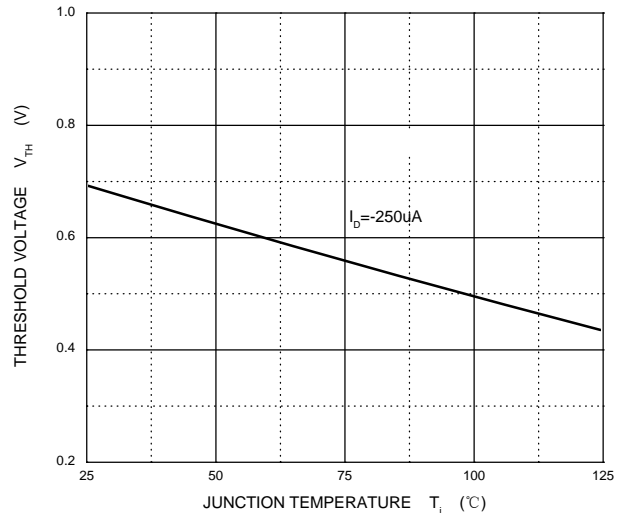

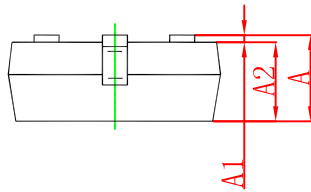
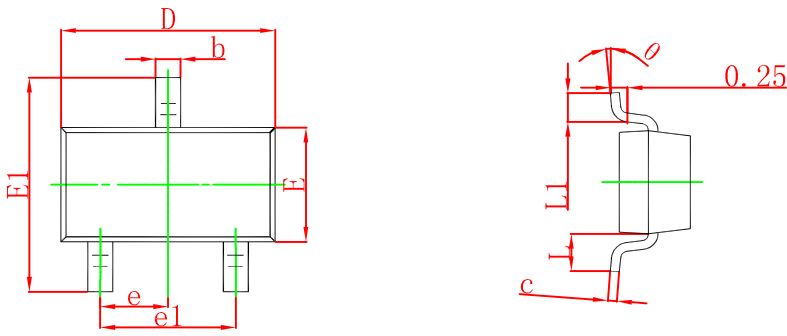

Symbol	Dimensions In Millimeters		Dimensions In Inches	
	Min	Max	Min	Max
A	0.900	1.150	0.035	0.045
A1	0.000	0.100	0.000	0.004
A2	0.900	1.050	0.035	0.041
b	0.300	0.500	0.012	0.020
c	0.080	0.150	0.003	0.006
D	2.800	3.000	0.110	0.118
E	1.200	1.400	0.047	0.055
E1	2.250	2.550	0.089	0.100
e	0.950 TYP		0.037 TYP	
e1	1.800	2.000	0.071	0.079
L	0.550 REF		0.022 REF	
L1	0.300	0.500	0.012	0.020
θ	0°	8°	0°	8°

SOT-23 Suggested Pad Layout

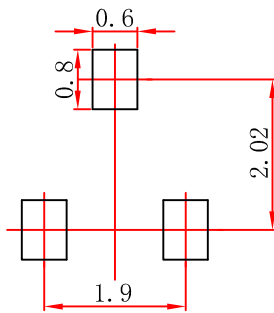

- Note:
1. Controlling dimension: in millimeters.
 2. General tolerance: $\pm 0.05\text{mm}$.
 3. The pad layout is for reference purposes only.

SOT-23 Embossed Carrier Tape

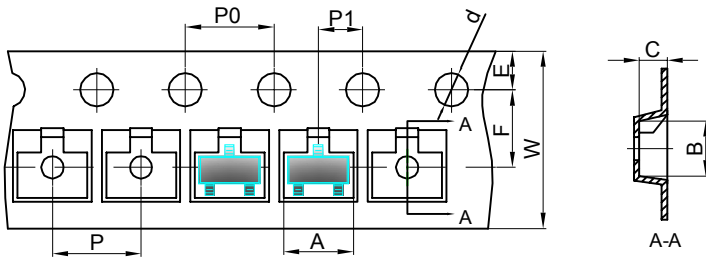

Packaging Description:

SOT-23 parts are shipped in tape. The carrier tape is made from a dissipative (carbon filled) polycarbonate resin. The cover tape is a multilayer film (Heat Activated Adhesive in nature) primarily composed of polyester film, adhesive layer, sealant, and anti-static sprayed agent. These reeled parts in standard option are shipped with 3,000 units per 7" or 17.8cm diameter reel. The reels are clear in color and is made of polystyrene plastic (anti-static coated).

Dimensions are in millimeter

Pkg type	A	B	C	d	E	F	P0	P	P1	W
SOT-23	3.15	2.77	1.22	Ø1.50	1.75	3.50	4.00	4.00	2.00	8.00

SOT-23 Tape Leader and Trailer

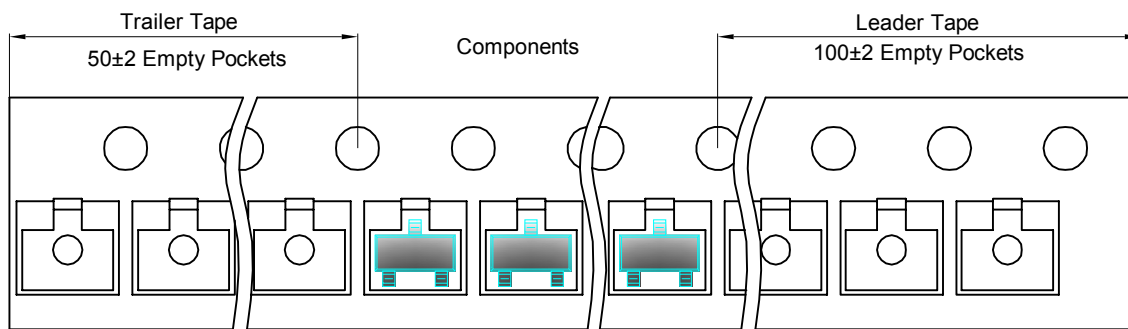

SOT-23 Reel

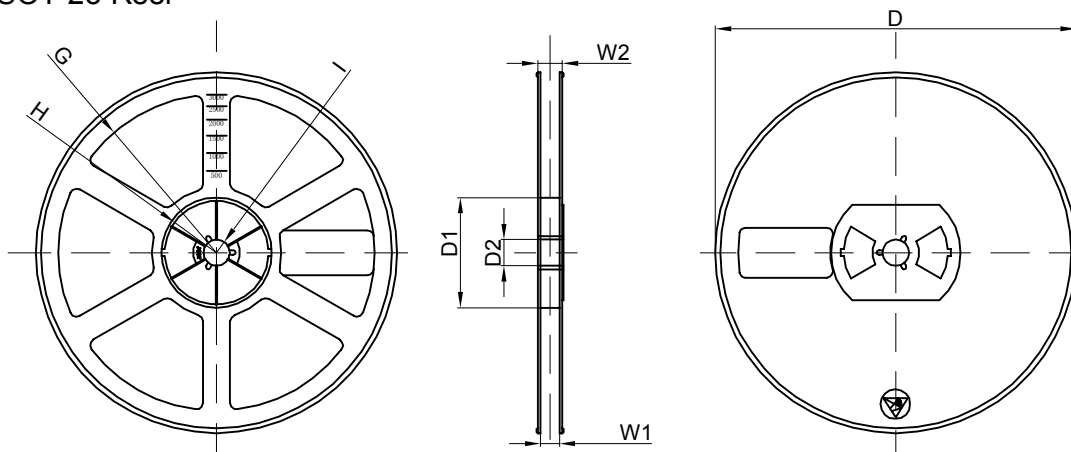

Dimensions are in millimeter

Reel Option	D	D1	D2	G	H	I	W1	W2
7"Dia	Ø178.00	54.40	13.00	R78.00	R25.60	R6.50	9.50	12.30

REEL	Reel Size	Box	Box Size(mm)	Carton	Carton Size(mm)	G.W.(kg)
3000 pcs	7 inch	30,000 pcs	203×203×195	120,000 pcs	438×438×220	